

FORCE

GENERAL CATALOGUE V8



Power you on

CERTIFICATE

Management system as per
ISO 9001 - 2008

In accordance with TUV NORD CERT procedures, it is hereby certified that
SHYANG YUN TOOLS CO., LTD.
No. 161, Sitou Rd., Shengang Township,
Taichung County 42663, Taiwan, Republic of China

FORCE

Management system is certified in accordance with the national standards in the following scope:

**Design, Development and Manufacturing of Hand Tools,
Auto Tools and Pneumatic Tools**

Certificate Registration No. 44.102.02211
Valid Period: May 31, 2018 to 03/31/2021

Valid until 03/31/2021
Issue/Registration No. 2017-04-03

TUV NORD CERT (Branch)
c/o TUV NORD CERT (Taiwan)

Ming Hsiung, 2018/05/28

This certificate was issued on 03/01/2018 in accordance with the TUV NORD CERT (Auto and Pneumatic) procedures and is subject to annual surveillance audits.

TUV NORD CERT Group | www.tuv-nord.com | TÜV NORD (Taiwan) | www.tuv-nord.com/ta



44.102.02211

General Information

This catalogue replaces all previous editions. All rights reserved in all countries. Reprinting and excerpts require a prior permission in writing by Shyang Yun Tools Co., Ltd.

The photographs and the technical details are of the articles at present offered.

Since we are constantly updating and improving our products to meet user needs and technological developments, we reserve the right to make modifications and changes with regard to photographs, specifications, sizes, packing, weights and performance without notice.

There is no liability for printing errors and correction or replacement supplies with regard to products already delivered.

Cancellations of all models and sets may be made at any time without there being any grounds for legal claim.

FORCE is a registered trademark.

All other trademarks mentioned in this document or website are the property of their respective owners.

The use of the word partner does not imply a partnership relationship between Shyang Yun Tools Co., Ltd. and any other company.

© Copyright by Shyang Yun Tools Co., Ltd.
All rights reserved.



Trolleys,
Tool Boxes,
Suitcases,
Workbenches,
Cabinets

Page

1-01~1-24



Automotive tools,
Chisels,
Pliers,
Clamps,
Pullers,
Special tools

Page

2-01~2-86



Spanners,
Screwdrivers,
Allen keys,
Wrenches

Page

3-01~3-76



1/4"

Socket sets,
Bits,
Sockets,
Ratchet handles
Accessories

Page

4-01~4-40



3/8"

Socket sets,
Bits,
Sockets,
Ratchet handles
Accessories

Page

5-01~5-32



1/2"

Socket sets,
Bits,
Sockets,
Ratchet handles
Accessories

Page

6-01~6-88



3/4"

Socket sets,
Sockets,
Ratchet handles
Accessories

Page

7-01~7-08



1"

Socket sets,
Sockets,
Ratchet handles
Accessories

Page

8-01~8-04



Air impact tools
Cordless impact tools

Page

9-01~9-50

FORCE

INDEX **GENERAL CATALOGUE V8**

Anything you need for tools...



Trolleys,
Tool Boxes,
Suitcases,
Workbenches,
Cabinets

Page
1-01~1-24



Automotive tools,
Chisels,
Pliers,
Clamps,
Pullers,
Special tools

Page
2-01~2-86



Spanners,
Screwdrivers,
Allen keys,
Wrenches

Page
3-01~3-76



1/4"
Socket sets,
Bits,
Sockets,
Ratchet handles
Accessories

Page
4-01~4-40



3/8"
Socket sets,
Bits,
Sockets,
Ratchet handles
Accessories

Page
5-01~5-32



1/2"
Socket sets,
Bits,
Sockets,
Ratchet handles
Accessories

Page
6-01~6-88



3/4"
Socket sets,
Sockets,
Ratchet handles
Accessories

Page
7-01~7-08



1"
Socket sets,
Sockets,
Ratchet handles
Accessories

Page
8-01~8-04



Air impact tools
Cordless impact tools

Page
9-01~9-50



50230-95
95pc Tool bag
L53.5 x W25.8 x H22.5 cm
1/10.8/11.8/1.3'



50231-33
Notebook bag with 34pc tools
L38.5 x W24 x H5 cm
5/20/21/1.2'



50234
Black suitcase
L45 x W33 x H15 cm
1/4.5/5.3/1.65'

50234-107
Black suitcase with 107pc tools
1/12.9/13.9/1.65'



50233
3-Layer tool box
L53.5 x W25.8 x H16.5 cm
1/6/7/1.5'

50233-48
3-Tier tool chest with 48pc tools
C5166 ; C2206 ; C5122
1/11.7/12.7/1.5'



50235
5-Layer tool box
L53.5 x W25.8 x H22.5 cm
1/7.6/9/1.9'

50235-101
5-Tier tool chest with 101pc of tools
C5153 ; C5142 ; C21114 ; C4482 ; C5136
1/18.2/19.2/1.9'

50235-124
5-Tier tool box with 124pc tools (S&M)
C5203 ; C5142 ; C21114 ; C3661 ; C5136
1/18/19/1.9'

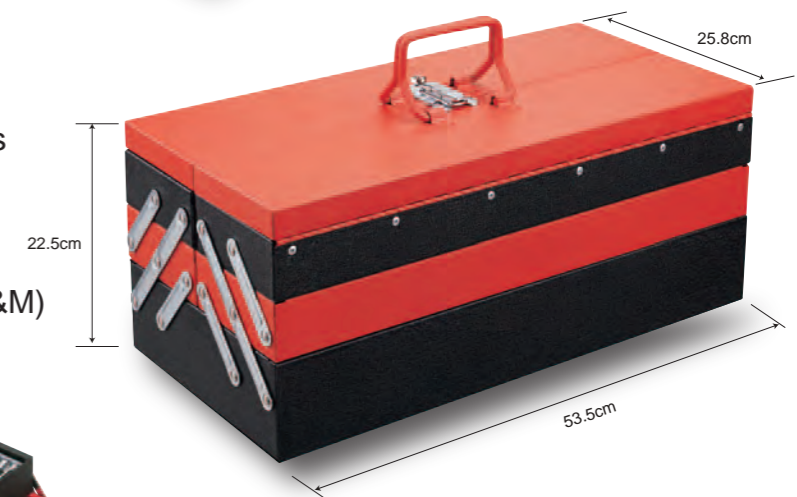



50222S
2-Drawer black tool lockable chest with top lid
L43.5xW24xH25cm 1/7.5/8.5/1.1'



50222S-38
2-Drawer lockable chest with 38pc tools
1pc/12.5kg/13.5kg/1.1'



50223S
3-Drawer black tool chest with top lid
L55.5 x W24 x H28 cm 1/12.5/13.5/2.2'

50223S-116
3-Drawer chest with 116pc tools
1/21.2/22.2/2.2'



50229S
9-Drawer black tool chest with top lid
L65.5 x W31 x H43 cm 1/26.2/28.2/4.3'

50229S-255
9-Drawer chest with 255pc tools (EVA)
1/51.4/53/4.3'



50253
Heavy-duty workbench with drawers & fiberboard
1/113.9/121.3/11.6'
With 10 pcs of 82023D 3" double hooks and 10 pcs of 82023S 3" single hook.
With 3-drawer tool box 50223.



PROFESSIONAL TOOLS

50254
Heavy-duty workbench with drawers & lockable cabinet
1/144.9/152.8/18.9'
With 10 pcs of 82023D 3" double hooks and 10 pcs of 82023S 3" single hook.
With 3-drawer tool box 50223.





50223
3-Drawer tool box (Black)



50223R
3-Drawer tool box (Red)

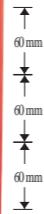

L70 x W47 x H34 cm
1pc / 27.4kg / 29.3kg / 5.9'

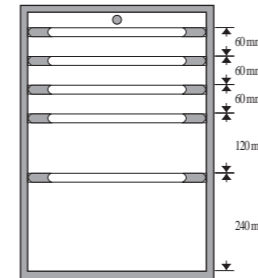
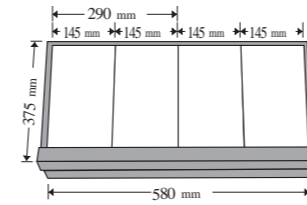
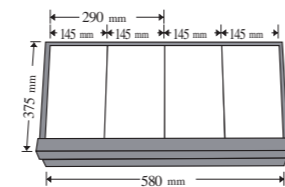

L80 x W50 x H103 cm
1pc / 62.6kg / 61.8kg / 14.8'

10215



10215A

10215B



10215R



10225
Practical 5-drawer tool box (Black)



10225R
Practical 5-drawer tool box (Red)

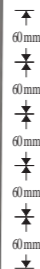

L69 x W46 x H49 cm
1pc / 38.7kg / 41.9kg / 8.9'

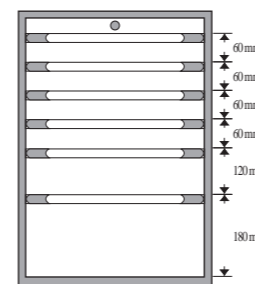
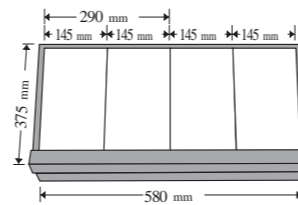
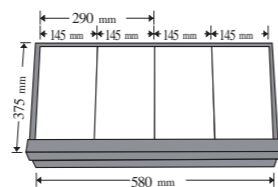

L80 x W50 x H103 cm
1pc / 65.5kg / 71kg / 14.8'

10216



10216A

10216B



10216R

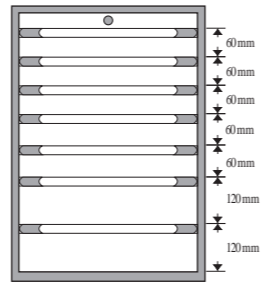
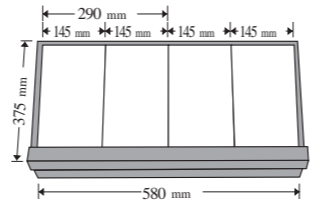

L80 x W50 x H103 cm
1pc / 67.3kg / 72.8kg / 14.8'

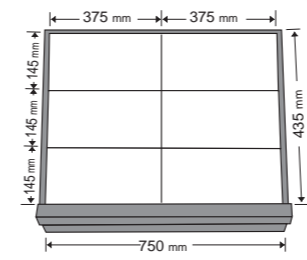

L95 x W50 x H103 cm
1pc / 97.7kg / 103.2kg / 20.2'

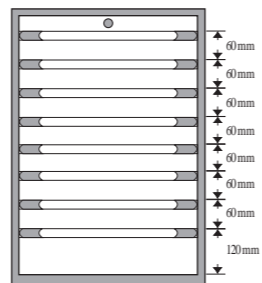
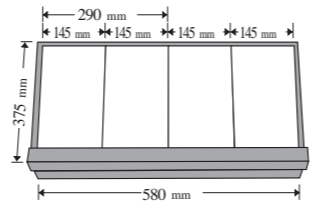

L80 x W50 x H103 cm
1pc / 70.3kg / 75.8kg / 14.8'

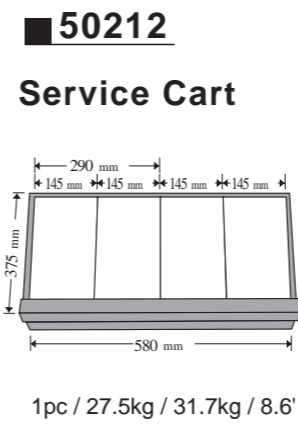

Hooks & Holders

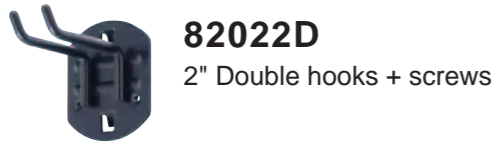

82022D
2" Double hooks + screws



82022DW
2" Double hooks + screws
(span is 3cm)



82023S
3" Single hook + screws



82023D
3" Double hooks + screws



82023U
3" U-shaped hook + screws



82026S
6" Single hook + screws



82026D
6" Double hooks + screws



82026U
6" U-shaped hook + screws



82028U
8" U-shaped hook + screws



10210H1
Socket holder



10210H2
Screwdriver holder



10210H3
Wrench holder



10210H4
T-handle tool holder

Apply tool box



50253-177

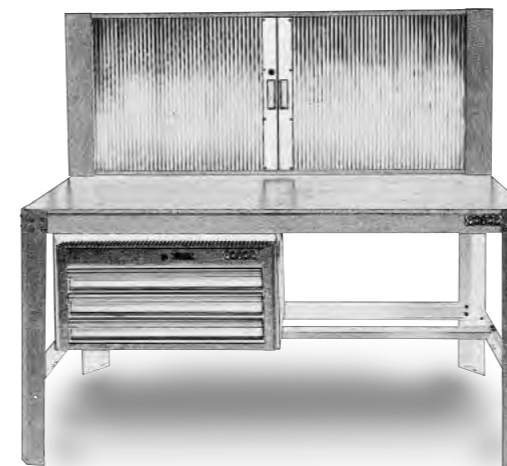

50254-177

177PC Tool Set(MM)

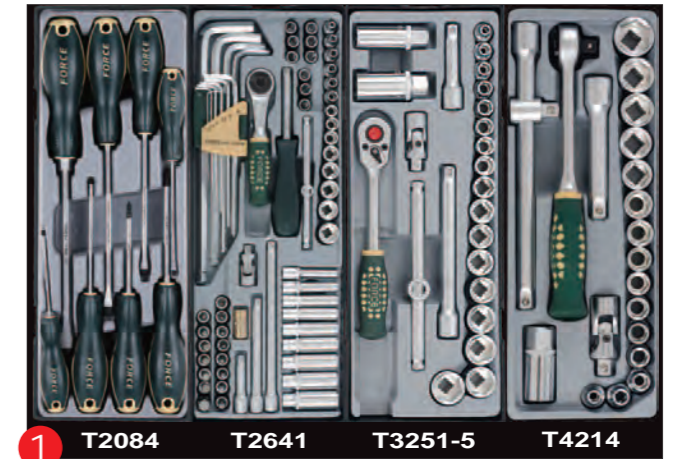

1 T2084 T2641 T3251-5 T4214



2 T5046 T5038 T5043A T5053



3 T5055 T5161 T5131 T5096

183PC Tool Set(MM)

245PC Tool Set(MM)

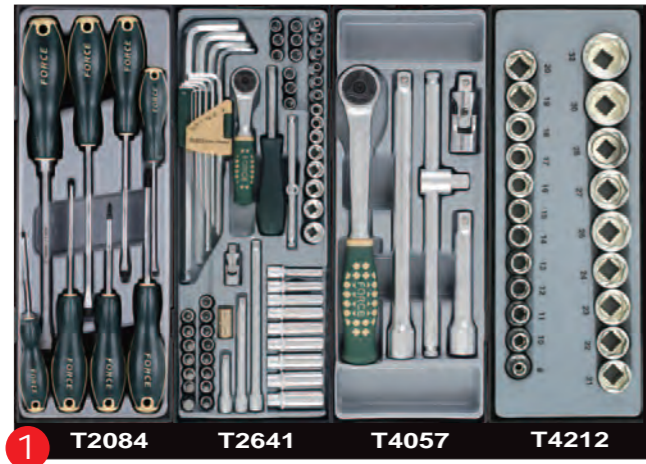

Apply tool box



- 50223-183
- 50223R-183



- 10225-183
- 10225R-183

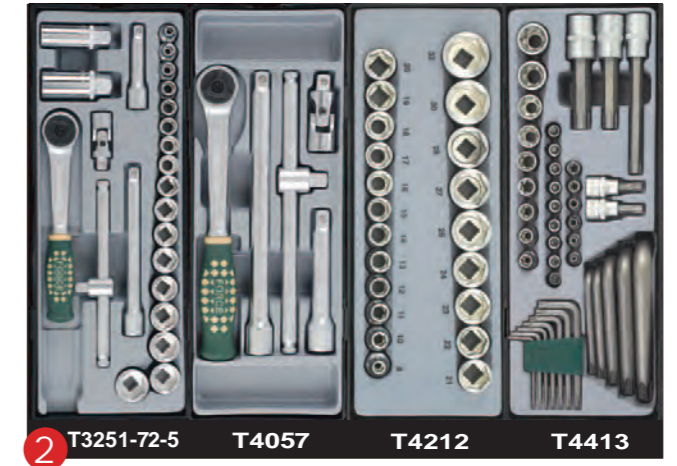
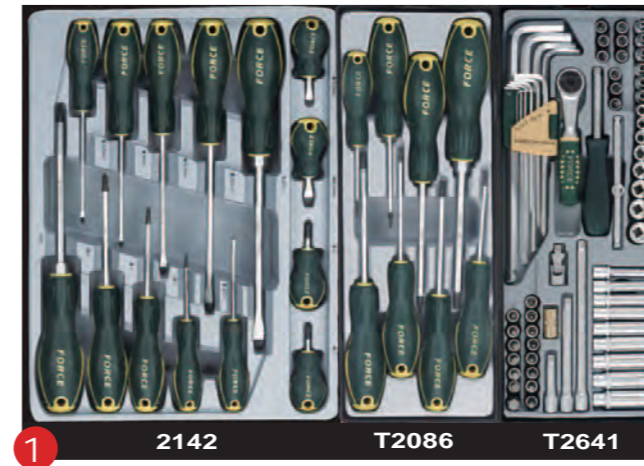

Apply tool box



- 10216-245
- 10216B-245
- 10216R-245
- 10216A-245



- 10217-245
- 10217B-245
- 10217R-245
- 10217A-245

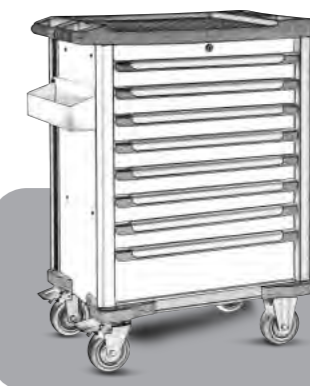

- 10218-245
- 10218B-245
- 10218R-245
- 10218A-245

286PC Tool Set(MM)

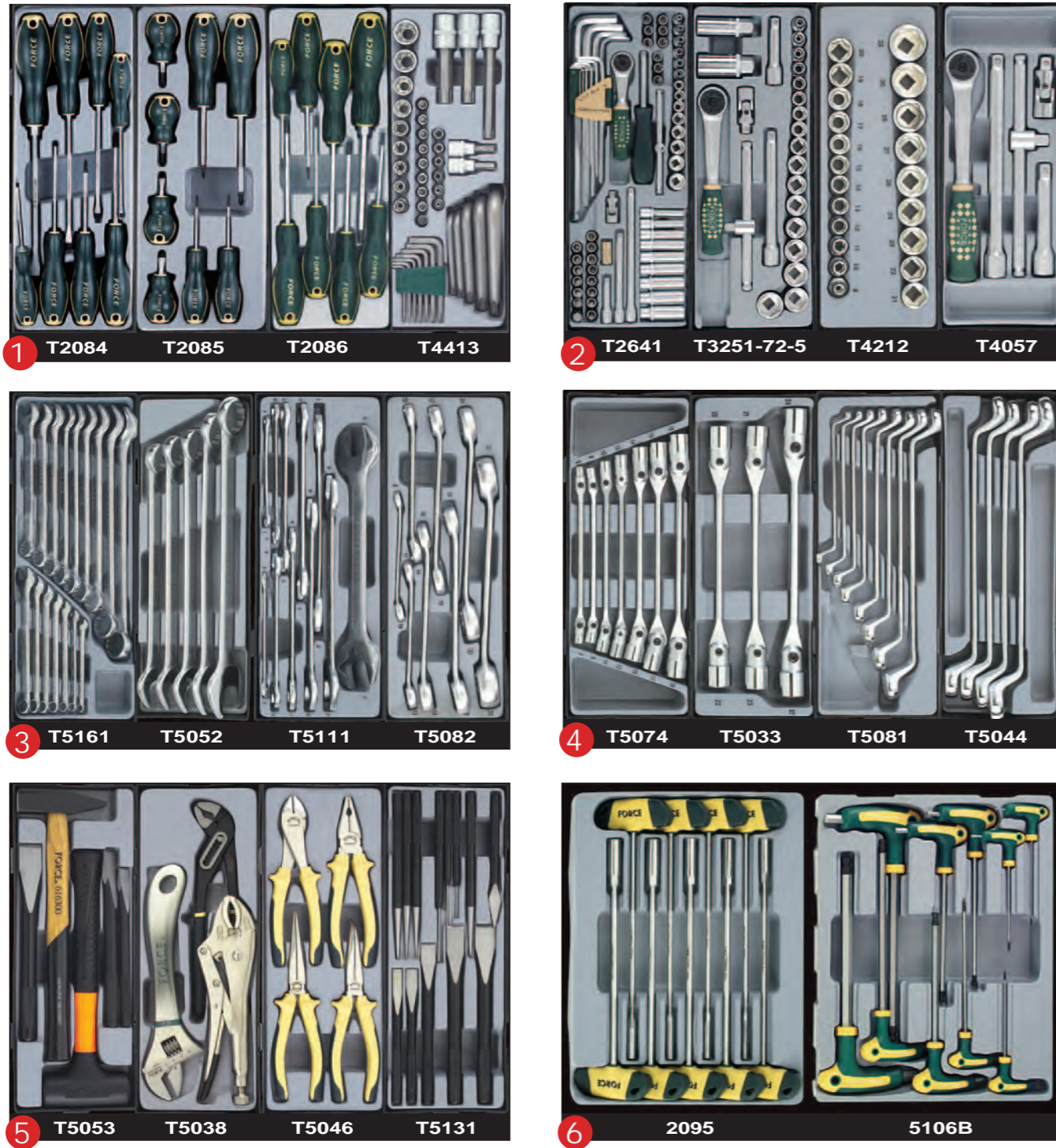

437PC Tool Set (MM)

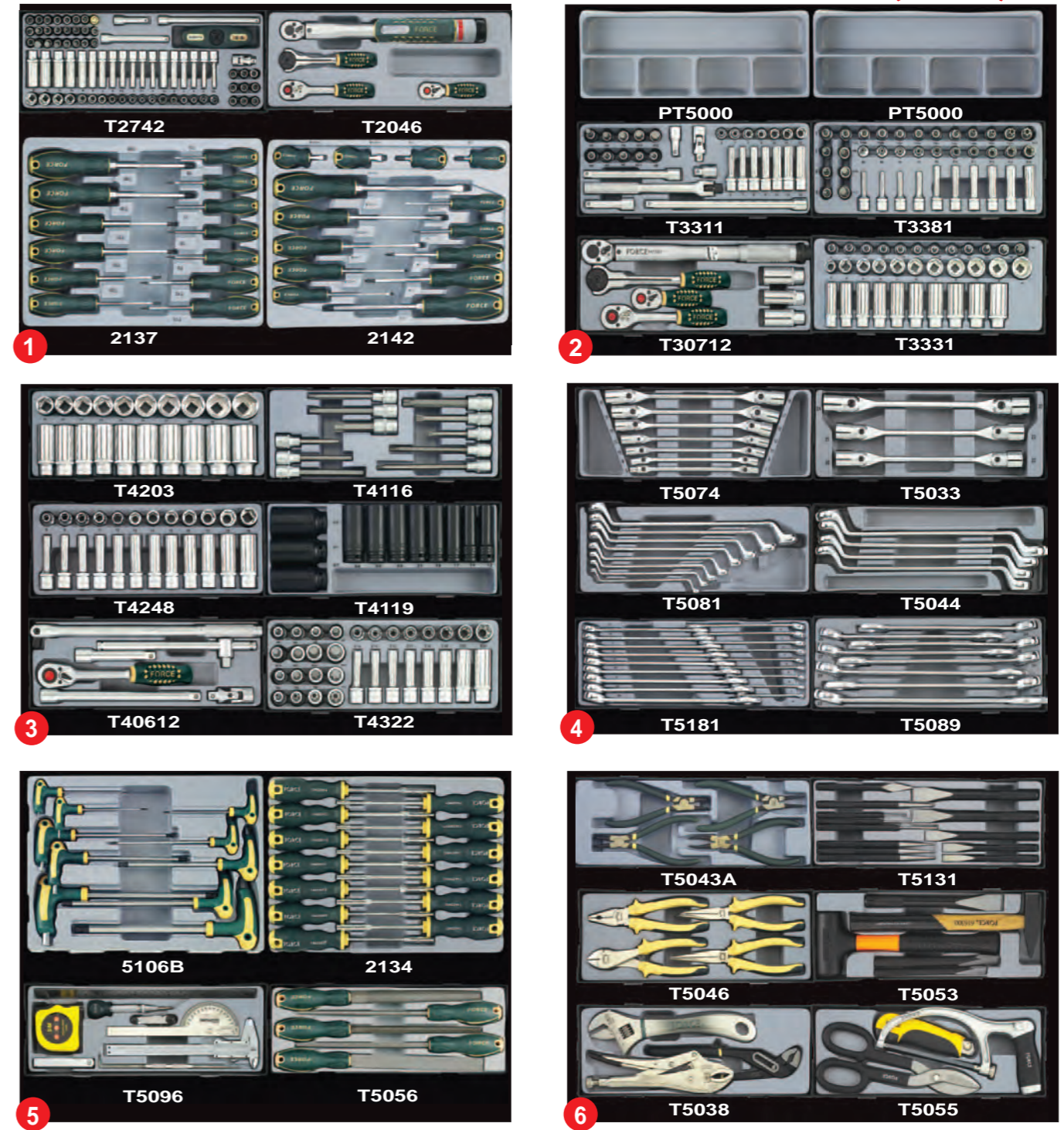

Apply tool box

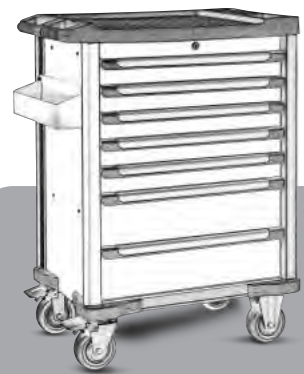

- 10217-286
- 10217B-286
- 10217R-286
- 10217A-286

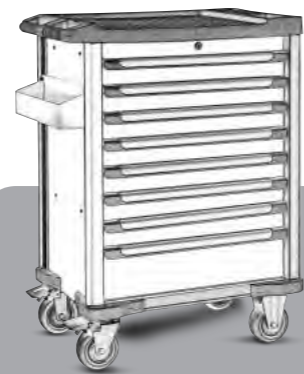

- 10218-286
- 10218B-286
- 10218R-286
- 10218A-286

Apply tool box

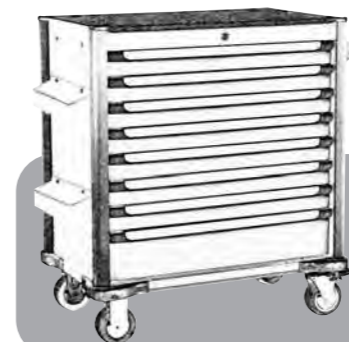

- 10318-437
- 10318B-437
- 10318R-437



T2045
4pc Ratchet handle set



T2046
4pc Ratchet handle set

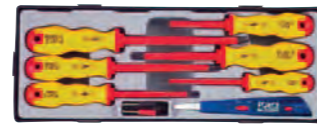

T20712
7pc Insulated screwdriver set

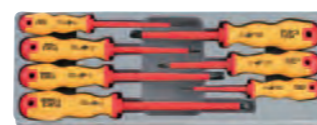

T20715
7pc Insulated screwdriver set



T30712
7pc Ratchet handle set



T3121
12pc 3/8" 6pt. Flank deep socket set

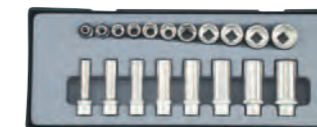

T3193
19pc 6pt. Flank socket set (SAE)

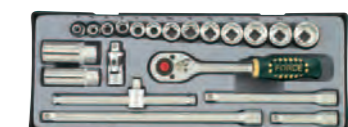

T3212
21pc 3/8" Socket set (SAE)



T20718
7pc Insulated screwdriver & voltage tester set



T20718-3
7pc Insulated screwdriver & voltage tester set



T2084
8pc Screwdriver set



T2085
8pc Screwdriver set



T3224
22pc 3/8" Universal socket set



T3251-5
24pc 3/8" 6pt. Flank socket set



T3251-5-15
24pc 3/8" 6pt. Flank socket set



T3251-5-18
24pc 3/8" 6pt. Flank socket set



T2086
8pc Star screwdriver set



T2086T
8pc Star tamperproof screwdriver set

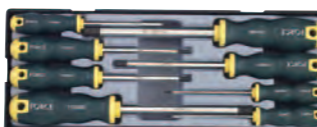

T20810
8pc Hex screwdriver set



T20810B
8pc Hex ball point screwdriver set



T3251-72-5
24pc 3/8" 6pt. Flank socket set



T3311
31pc 3/8" Socket combination set



T3322
32pc 3/8" Socket set (MM & SAE)



T3322-15
32pc 3/8" Socket set (MM & SAE)



T2173
Jeweler screwdriver & (de-)magnetizer set



T2221B
22pc Screwdriver & L key set



T2234L
23pc Screwdriver & L key set



T2234LB
23pc Screwdriver & L key set



T3322-23
32pc 3/8" Socket set (MM & SAE)



T3322-24
32pc 3/8" Socket set (MM & SAE)



T3331
33pc 3/8" 6pt. Flank & star socket set



T3361
36pc 3/8" Socket combination set



T2641
65pc 1/4" Socket combination set



T2641-15
65pc 1/4" Socket combination set



T2641-24
65pc 1/4" Socket combination set

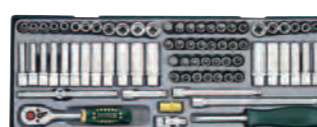

T2741
74pc Socket combination set (MM & SAE)

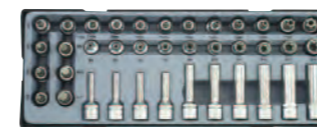

T3381
38pc 3/8" Star & spline set



T3521
52pc Star set



T4057
5pc 1/2" Accessory set



T4057-15
5pc 1/2" Accessory set

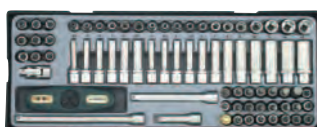

T2742
74pc Socket combination set



T2742-15
74pc Socket combination set



T2742-18
74pc Socket combination set



T30711
7pc Ratchet handle set



T4057-24
5pc 1/2" Accessory set



T40612
6pc 1/2" Accessory set



T40612-24
6pc 1/2" Accessory set



T40613
6pc 1/2" Accessory set

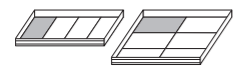



T40613-23
6pc 1/2" Accessory set



T4116
11pc 1/2" Mixed socket bit set



T4119
11pc 1/2" 6pt. Flank impact deep socket set



T4122
12pc 1/2" Socket bit set



T4143
14pc 1/2" 6pt. Flank deep socket set



T4193
19pc 1/2" 6pt. Flank impact socket set



T4194
19pc 1/2" 6pt. Flank socket set (SAE)



T4203
20pc 1/2" 6pt. Flank socket set



T4205
20pc 1/2" DR. Impact socket bit set (one-piece)



T4212
21pc 1/2" 6pt. Flank socket set



T4214
21pc 1/2" 6pt. Flank socket set



T4214-15
21pc 1/2" 6pt. Flank socket set



T4248
24pc 1/2" 6pt. Flank socket set



T4248S
24pc 1/2" 6pt. Flank Socket set(SAE)



T4281
27pc Socket bit set

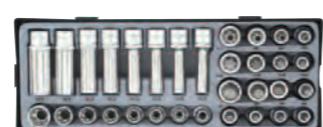

T4322
32pc 1/2" Star & spline set



T4411
41pc Star set



T4413
41pc Star set



T5021
2pc Pliers set



T5023
2pc Adjustable wrench set



T5033
3pc Hinged socket wrench set



T5034
3pc Pliers set



T5036
3pc Adjustable wrench set



T5036A
3pc Adjustable wrench set



T5038
3pc Pliers set



T5043A
4pc Snap ring pliers set



T5044
4pc 75° Offset ring wrench set



T5045
4pc Pliers set



T5046
4pc Pliers set



T5047
4pc Pliers set



T50410
4pc Insulated pliers set

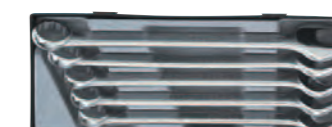

T5052
5pc Combination wrench set



T5053
5pc Hammer & chisel set



T5053A
5pc Hammer & chisel set



T5053F
5pc Hammer & chisel set



T5053AF
5pc Hammer & chisel set



T5055
5pc Cutting tools set



T5056
5pc File set



T5057
5pc Multi-grip pliers set



T50616S
6pc Hinged socket wrench set (SAE)



T50617
6pc 15° Offset star ratchet ring wrench set



T50618-18
6pc Spark plug combination set



T50618-24
6pc Spark plug combination set



T50633AF
6pc Hammer, chisel and punch set



T5074
7pc Hinged socket wrench set



T5075
7pc Hinged star socket wrench set



T5079S
7pc 75° Offset ring wrench set (SAE)



T50710
7pc Flare nut wrench set (SAE)



T5081
8pc 75° Offset ring wrench set (MM)



T5081S
8pc 75° Offset ring wrench set (SAE)



T5082
8pc Flare nut wrench set



T5085
8pc 45° Offset ring wrench set (MM)



T5085S
8pc 45° Offset ring wrench set (SAE)



T5089
8pc Combination wrench set (SAE)



T50810
8pc Ratchet ring wrench set



T50811
8pc 15° Offset ratchet ring wrench set



T50812
8pc Flat gear wrench set (SAE)



T50813
8pc Reversible gear wrench set (SAE)

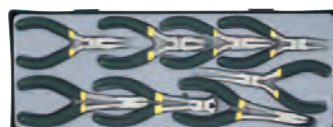

T50814
8pc Mini pliers set



T50817
8pc Double ended 6pt.-6pt. socket wrench set



T50822
8pc Hammer & chisel set



T5096
9pc Measuring tools set



T50918
9pc Ratchet Flare nut wrench



T5111
11pc Double open end wrench set



T5111S
11pc Double open end wrench set (SAE)



T5114
11pc Angle wrench set



T5122
12pc Auto tool kit set



T51210
12pc Flat gear wrench set (MM)



T51211
12pc Reversible gear wrench set (MM)



T51214
12pc Midget combination wrench



T51215
12pc Flat gear wrench & holder set (SAE)



T51215R
12pc Reversible gear wrench & holder set (SAE)

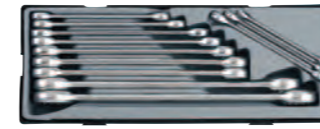

T51226
12pc Flat ring wrench set



T51226A
12pc Double ring wrench set (15° bowed)



T5131
13pc Chisel & punch set



T5134
13pc Combination wrench set (SAE)



T5135S
13pc Crowfoot flare nut wrench set (SAE)



T5161
16pc Combination wrench set



T5164
16pc Flat gear wrench & holder set



T5164R
16pc Reversible gear wrench & holder set



T5172
17pc Crowfoot flare nut wrench set (MM)

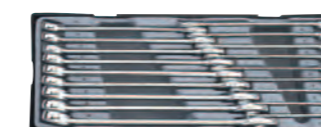

T5181
18pc Combination wrench set



T5331
33pc Screw repair tools set



T5861
86pc Grade nut fastener set



T51811
181pc Rivet pliers set



T905M2
5pc Auto body tools

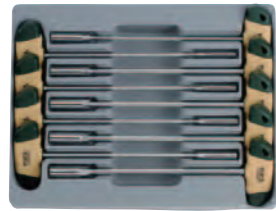

2095
9pc Hex nut driver T handle set (MM)

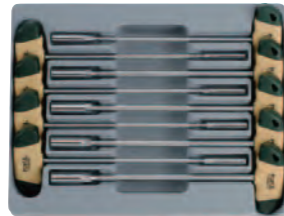

2095S
9pc Hex nut driver T handle set (SAE)



2096
9pc Star nut driver T handle set

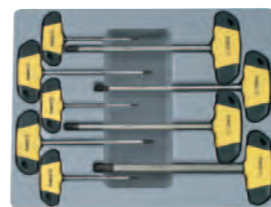

2097
9pc Hex screwdriver T handle set (MM)



50911
9pc Half-moon ring wrench

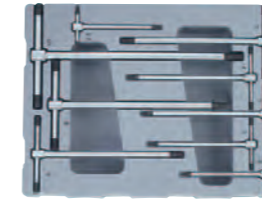

50912
9pc T shaped hex key

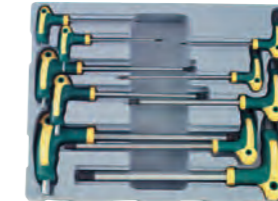

5106B
10pc Hex ball point grip key set

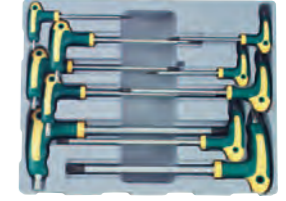

51010T
10pc Star tamperproof grip key set

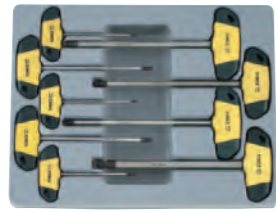

2097B
9pc Hex ball point screwdriver T handle set

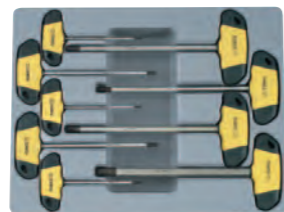

2097S
9pc Hex screwdriver T handle set (SAE)



2108
10pc Hammer screwdriver set



2109
10pc Hammer screwdriver set

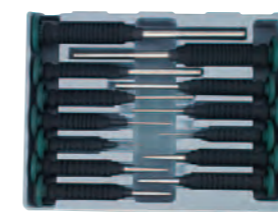

5138
13pc Quakeproof and safe punch set

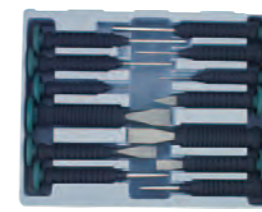

5139
13pc Quakeproof chisel & punch set



54111
411pc Tie tape pliers kits



2125
12pc Insulated screwdriver set



2126
12pc Insulated screwdriver set



2134
13pc Hex nut driver set



2137
13pc Star screwdriver set

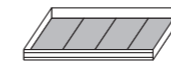

50823
8pc Utility tool set



51015
10pc Cutting & sawing Utility set

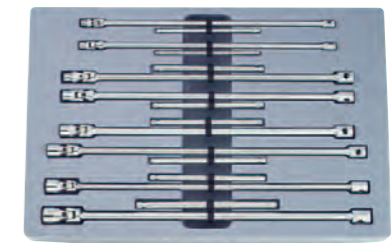

50816
8pc Universal long nut driver



2137T
13pc Star tamperproof screwdriver set



2141
14pc Star screwdriver T handle set



2141T
14pc Star tamperproof screwdriver T handle set



2142
14pc Screwdriver set



4215
21pc 1/2" Impact wrench & socket set



5048
4pc terminal & stripper pliers set



50713
7pc Auto body repair tool set

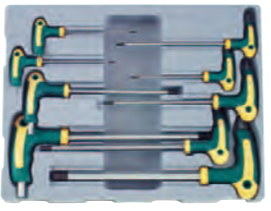

50910BS
9pc Hex ball point grip key set (SAE)

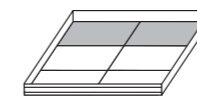

50619
6pc Wheel special tools kits set



C20913
9pc Insulated screwdriver set



C21114
11pc Screwdriver set



C2193
19pc Insulated screwdriver set



C2206
20pc Screwdriver and L key set



C3661
66pc Socket combination set (S&M)



C4482
48pc 1/4" & 1/2" Socket combination set



C50412
4pc Insulated pliers set



C50630
6pc Utility set



C50631
6pc Utility set



C51220
12pc Utility set



C51221
12pc Utility set



C5136
13pc Combination set



C5142
14pc Pliers and key set



C5153
15pc Combination wrench set



C5166
16pc Wrench and pliers set



C5203
20pc Combination wrench set (S&M)



C5211
21pc Wrench & insulated pliers set

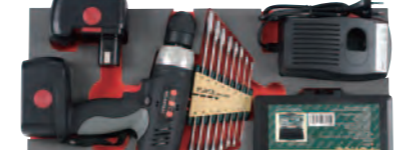

C5541
54pc Cordless drill & wrench set

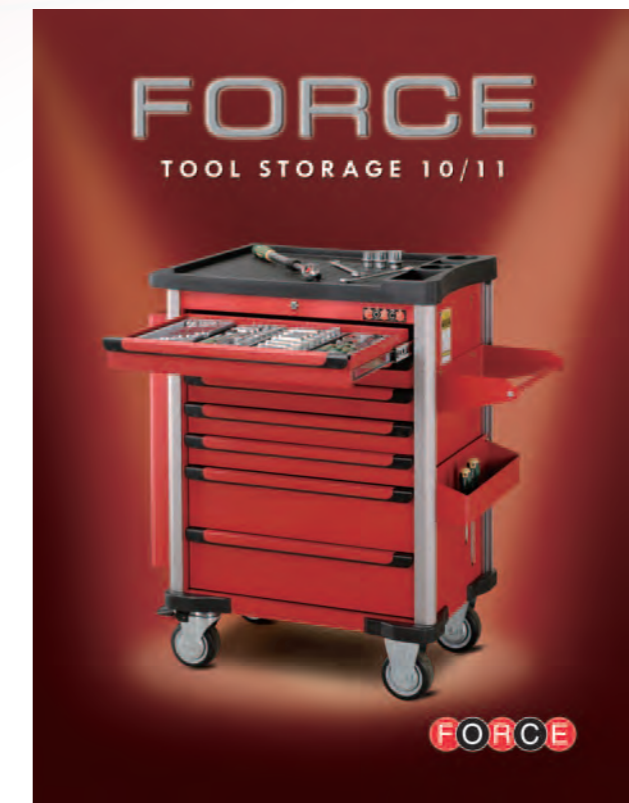

For more information on FORCE trolleys, tool boxes, suitcases, workbenches and cabinets, please refer to the above catalogue,



2pc Torque adapter (spark plug special)

| | | |
|---------------|---|------|
| K3021 | | |
| Part no. | 24/12.0/13.0/0.8' | 500g |
| 832 318...324 | Content: 3/8"DR. 2-Torque adapter 18Nm; 24Nm | |



3pc Step wrench set

| | | |
|-----------------|---|------|
| 4031 | | |
| Part no. | 20/17.0/18.0/1.4 | 850g |
| 802412 68901 | Content: 1/2"DR. 1-1/2"DR. Square hole ratchet handle 1-Slotted step wrench 1.5x8.9 3/8"(9.35mm); 7/16"(9.75mm); 15/32"(12mm); 1/2"(12.8mm); 35/64"(13.8mm); 3/4"(18.4mm); 27/32"(21.4mm); 7/8"(21.9mm) | |
| 68902 | 1-Hex step wrench 3/8"; 1/2"; 3/4"; 1" | |



2pc Pliers set

| | | |
|------------------|--|-------|
| 5021 | | |
| Part no. | 6/10.5/11.5/0.9' | 1750g |
| 613250 614250 | Content: 1-Waterpump pliers 10" 1-Locking pliers 10" | |



2pc Adjustable wrench set

| | | |
|--------------------|---|-------|
| 5023 | | |
| Part no. | 6/10.2/11.2/0.9' | 1700g |
| 649200B 649300B | Content: 2-Adjustable gauged wrench 8" (200mmL) 12" (300mmL) | |

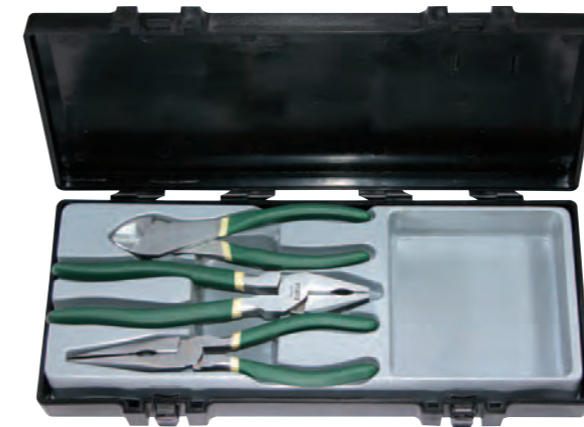

3pc Pliers set

| | | |
|----------------------------|--|-------|
| 5034 | | |
| Part no. | 6/10.0/11.0/0.9' | 1660g |
| 610200 611215 612175 | Content: 1-Long nose pliers 8" 1-Combination pliers 8.5" 1-Diagonal pliers 7" | |



3pc Adjustable wrench set

| | | |
|----------------------------|---|-------|
| 5036 | | |
| Part no. | 6/13.3/14.3/0.9' | 2210g |
| 649200 649250 649300 | Content: 3-Adjustable gauged wrench 8"(200mmL) 10"(250mmL) 12" (300mmL) | |



3pc Adjustable wrench set

| | | |
|-------------------------------|---|-------|
| 5036A | | |
| Part no. | 6/12.2/13.2/0.9' | 2040g |
| 649200A 649250A 649300A | Content: 3-Adjustable gauged wrench 8" (200mmL) 10" (250mmL) 12" (300mmL) | |



3pc Pliers set

| | | |
|------------------------------|---|-------|
| 5038 | | |
| Part no. | 6/12.8/13.8/0.9' | 2130g |
| 649250B 613B250 614250 | Content: 1-Adjustable wrench 10" 1-Waterpump pliers 10" 1-Locking pliers 10" | |



4pc Stud extractor set (MM)

| | | |
|-------------|--------------------|------|
| 5042 | | |
| Part no. | 20/16.5/17.5/0.82' | 825g |

818 06...12
Content:
4-Stud extractor 6; 8; 10; 12 mm

4pc Stud extractor set (SAE)

| | | |
|--------------|--------------------|------|
| 5042S | | |
| Part no. | 20/16.5/17.5/0.82' | 825g |

818 1.4...7.16
Content:
4-Stud extractor 1/4"; 5/16"; 3/8";
7/16"



4pc Pliers set

| | | |
|-------------|-----------------|-------|
| 5045 | | |
| Part no. | 6/9.9/10.9/0.9' | 1650g |

610B200
611B175
612B175
673B215
Content:
1-Long nose pliers 8"
1-Combination pliers 7"
1-Diagonal pliers 7"
1-Slip joint pliers 8.5"



4pc Pliers set

| | | |
|-------------|------------------|-------|
| 5047 | | |
| Part no. | 6/11.8/12.8/0.9' | 1970g |

5047P1
5047P2
5047P3
5047P4
Content:
1-Long nose straight pliers 11"
1-Long nose 45° pliers 11"
1-Long nose 90° pliers 11"
1-Multi-purpose 4 points gripping
pliers 11"



5pc Hammer chisel set

| | | |
|-------------|------------------|-------|
| 5053 | | |
| Part no. | 6/14.5/16.5/0.9' | 2415g |

616300
616400
60215180
60219180
60225220
Content:
1-Enginer hammer 300g
1-Rubber hammer 400g (280mmL)
3-Chisel
15mm (180mmL)
19mm (180mmL)
25mm (220mmL)

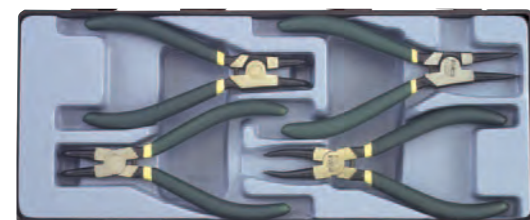

4pc Snap ring pliers set

| | | |
|--------------|-------------------|-------|
| 5043A | | |
| Part no. | 6/9.5/10.5.8/0.9' | 1800g |

609ASO
609ASC
609ABO
609ABC
Content:
4-Snap ring pliers
External straight tip 1.8mm (open)
Internal straight tip 1.8mm (close)
External 90° bent tip 1.8mm (open)
Internal 90° bent tip 1.8mm (close)



4pc Pliers set

| | | |
|-------------|-----------------|-------|
| 5046 | | |
| Part no. | 6/9.9/10.9/0.9' | 1650g |

610B200
610B200B
611B175
612B175
Content:
1-Long nose pliers 8"
1-Bent long nose pliers 8"
1-Combination pliers 7"
1-Diagonal pliers 7"



5pc Fill/Drain plug key set

| | | |
|-------------|--------------------|------|
| 5051 | | |
| Part no. | 25/12.0/13.0/0.64' | 480g |

5051-1
5051-2
5051-3
5051-4
5051-5
Content:
5-Fill/Drain plug key
17mmHex - 14mmHex
10mmHex - 12mmHex
9mmHex - 5/16"Hex
8mmSq. - 13mmSq.
3/8"Sq. - 11mmSq.



5pc Chisel punch set

| | | |
|-------------|-------------------|------|
| 5054 | | |
| Part no. | 40/20.2/21.5/1.3' | 505g |

60212150
603150
6044190
6063185
6074185
Content:
1-Chisel 12mm (150mmL)
1-Cape chisel (150mmL)
1-Pin punch 4mm (190mmL)
1-Taper punch 3mm (185mmL)
1-Center punch 4mm (185mmL)



5pc Cutting tools set

| | | |
|-------------|-----------------|-------|
| 5055 | | |
| Part no. | 6/9.5/10.5/0.9' | 1583g |

- Content:
- 5055P1 1-Straight shears
 - 66302 1-Mini hacksaw frame 6"
 - 5055P3 2-Saw blade
 - 5055P4 1-Utility knife (include 3pc blades)



5pc File set

| | | |
|-------------|------------------|-------|
| 5056 | | |
| Part no. | 6/10.2/11.2/0.9' | 1690g |

- Content:
- 5056P1 1-8" Flat file
 - 5056P2 1-8" Half round file
 - 5056P3 1-8" Round file
 - 5056P4 1-8" Square file
 - 5056P5 1-8" Triangular file

NEW



5pc Chisel set

| | | |
|--------------|-------------------|------|
| 50510 | | |
| Part no. | 30/26.5/27.6/0.5' | 887g |

- Content:
- 602 10150...22200 5-Chisel
 - 10(150mmL); 12(150mmL); 15(180mmL); 19(200mmL); 22(200mmL)

NEW



5pc Center punch set

| | | |
|--------------|-------------------|------|
| 50511 | | |
| Part no. | 30/18.8/19.8/0.5' | 627g |

- Content:
- 607 25185...10185 5-Center punch
 - 2.5(185mmL); 4(185mmL); 6(185mmL); 8(185mmL); 10(185mmL)

NEW



5pc Chisel set

| | | |
|--------------|-------------------|------|
| 50512 | | |
| Part no. | 30/14.4/15.4/0.5' | 480g |

- Content:
- 606 2185...6185 5-Taper punch
 - 2(185mmL); 3(185mmL); 4(185mmL); 5(185mmL); 6(185mmL)



6pc Impact driver set

| | | |
|--------------|--------------------|------|
| 5064L | | |
| Part no. | 20/19.0/20.0/0.62' | 950g |

- Content: 1/2" DR.
- 8174 1- Impact driver
 - 15180 2...3 4- 5/16" Bit
 - 15380 09...11 Phillips PH.2; PH.3 (80mmL)
 - 81045A Slotted 9; 11 mm (80mmL)
 - 1- Impact bit holder 1/2"DR.x5/16"

6pc Fill/Drain plug key set

| | | |
|-------------|--------------------|------|
| 5061 | | |
| Part no. | 25/17.5/18.5/0.64' | 700g |

- Content:
- 5061-1 6-Fill/Drain plug key
 - 5061-2 5/16"Hex - 3/8"Hex
 - 5061-3 8mmSq. - 3/8"mmSq.
 - 5061-4 11mmSq. - 12mmHex
 - 5061-5 13mmSq. - 14mmHex
 - 5061-6 17mmHex - 1/2"Hex
 - 8mmHex - 10mmHex



6pc Brake spanner set

| | | |
|--------------|-------------------|------|
| 50612 | | |
| Part no. | 30/20.5/21.5/1.3' | 680g |

- Content:
- 6080610 6-Brake spanner
 - 6080610 1/4"Sq. - 10mmSq.
 - 6080608 1/4"Sq. - 5/16"OE
 - 6080810 8mmHex - 10mmHex
 - 6080911 9mmHex - 11mmHex
 - 6080607 1/4"Hex - 7mmHex
 - 6081109 7/16"OE - 11/32"Sq.

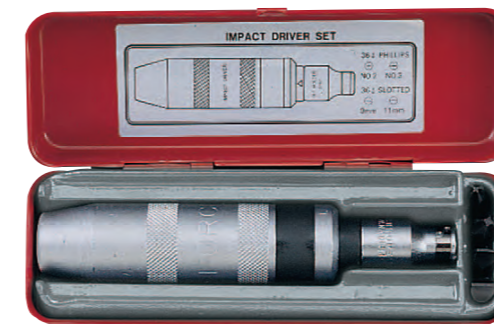

6pc Impact driver set

| | | |
|-------------|--------------------|------|
| 5064 | | |
| Part no. | 20/19.0/20.0/0.62' | 950g |

- Content: 1/2" DR.
- 8174 1- Impact driver
 - 15136 2...3 4- 5/16" Bit
 - 15336 09...11 Phillips PH.2; PH.3 (36mmL)
 - 81045A Slotted 9; 11 mm (36mmL)
 - 1- Impact bit holder 1/2"DR.x5/16"



6pc Pin punch set

| | | |
|-----------------|---|------|
| 50613 | | |
| Part no. | 30/16.7/17.7/1.3' | 540g |
| 604 2140...8215 | Content: 6-Pin punch 2mm (140mmL); 3mm (150mmL); 4mm (190mmL); 5mm (200mmL); 6mm (210mmL); 8mm (215mmL) | |



6pc Spring pin punch set

| | | |
|-------------------|---|------|
| 50614 | | |
| Part no. | 100/23.6/24.6/0.9' | 236g |
| 605 19090...79150 | Content: 6- Spring pin punch 1.9mm (90mmL); 2.9mm (95mmL); 3.9mm (115mmL); 4.9mm (115mmL); 5.9mm (140mmL); 7.9mm (150mmL) | |

NEW



6pc Hammer, chisel and punch set

| | | |
|-----------------|---|-------|
| T50633AF | | |
| Part no. | 6/13.4/14.4/0.73' | 2230g |
| 616F032 | Content: 1-Riveting hammer 32mm | |
| 616A400 | 1-Soft face hammer 400gw | |
| 60226200C | 1-Ribbed chisel 26mm(200mmL) | |
| 604 4190...6210 | 2-Pin punch 4mm(190mmL); 6mm(210mmL) | |
| 6074185 | 1-Center punch 4mm(185mmL) | |

NEW



6pc Self-locking multi-grip pliers set

| | | |
|--------------|--|-------|
| 50635 | | |
| Part no. | 3/13.5/14.5/1.5' | 4520g |
| 67901 | Content: 6-Self-locking multi-grip pliers | |
| 67902 | Wide flat jaws | |
| 67903 | Double curved jaws | |
| 67904 | Wide curved jaws | |
| 67905 | Angled jaws | |
| 67906 | Straight jaws | |
| | Mini straight jaws | |



7pc Stud extractor set (MM)

| | | |
|-------------|---|-------|
| 5078 | | |
| Part no. | 12/18.0/19.0/0.9' | 1500g |
| 818 05...14 | Content: 7-Stud extractor 5; 6; 7; 8; 10; 12; 14 mm | |

NEW



7pc Auto body repair tool set

| | | |
|---------------|---------------------------------------|-------|
| 50713B | | |
| Part no. | 3/22.0/23.0/1.5' | 7000g |
| 62602 | Content: 1-Pick & finishing hammer | |
| 62603 | 1-Light shrinking hammer | |
| 62604 | 1-Standard bumping hammer | |
| 68301 | 1-Utility dolly | |
| 68302 | 1-Curved dolly | |
| 68303 | 1-Heel dolly | |
| 68304 | 1-Toe dolly | |

NEW



7pc Locking pliers & clamp set

| | | |
|---------------|---|-------|
| 50721 | | |
| Part no. | 3/14.0/15.0/1.5' | 4650g |
| 614 125...250 | Content: 2-Locking pliers 5"; 10" | |
| 614A175 | 1-Locking pliers (straight jaw) 7" | |
| 615150 | 1-Long nose locking pliers 6" | |
| 66011 | 1-Locking "C" clamp 11" with easy release | |
| 66101 | 1-Sheet metal tool | |
| 66201 | 1-Welding clamp | |

NEW



7pc Long tapered punch set (10" L)

| | | |
|------------------|---|-------|
| 50722 | | |
| Part no. | 12/18.0/19.0/0.9' | 1500g |
| 60610 3.32...3.8 | Content: 7-3/32"(1/4"); 1/8"(5/16"); 3/16" (3/8"); 7/32"(7/16"); 1/4"(1/2"); 5/16"(5/8"); 3/8"(3/4") | |



8pc Mini pliers set

| | | |
|--------------|------------------------------------|-------|
| 50814 | | |
| Part no. | 6/8.4/9.4/0.9' | 1400g |
| 50814P1 | Content: 1-Round nose pliers 5" | |
| 50814P2 | 1-Flat nose pliers 5" | |
| 50814P3 | 1-Combination pliers 5" | |
| 50814P4 | 1-Long nose pliers 5" | |
| 50814P5 | 1-Needle nose pliers 6" | |
| 50814P6 | 1-Bent nose pliers 6" | |
| 50814P7 | 1-Cutter pliers 6" | |
| 50814P8 | 1-Diagonal pliers 6" | |



9pc Measuring tools set

| | | |
|-------------|------------------|-------|
| 5096 | | |
| Part no. | 6/10.0/11.0/0.9' | 1666g |

| | |
|--------|--------------------------------------|
| 5096P1 | Content: |
| 5096P2 | 1-Stainless steel vernier caliper |
| 5096P3 | 1-Auto center punch |
| 5096P4 | 1-Stainless steel straight rule 30cm |
| 5096P5 | 1-Stainless steel protractor |
| 5096P6 | 1-Screw pitch gauges 0.25-6 (MM) |
| 61802 | 1-Screw pitch gauges 4-62 (SAE) |
| 5096P7 | 1-26 sizes Feeler gauges (SAE & MM) |
| 5096P8 | 1-Steel scriber |
| 5096P8 | 1-5m measuring tape |



10pc Insulated pliers & screwdriver set

| | | |
|--------------|----------------|-------|
| 51014 | | |
| Part no. | 3/8.5/9.5/1.5' | 2830g |

| | |
|---------|--|
| 6903180 | Contents: |
| 6904160 | 1-Insulated combination pliers 7" |
| 6905160 | 1-Insulated long nose pliers 6" |
| 6907250 | 1-Insulated diagonal cutting pliers 6" |
| 6907250 | 1-Insulated water pump pliers (Curved jaw) 10" |

| | | |
|--------------|----------------|-------|
| 51014 | | |
| Part no. | 3/8.5/9.5/1.5' | 2830g |

| | |
|-----------------|--------------------------------------|
| 88401 | 1-Screwdriver probe voltage tester |
| | Testing range: 110~250V AC. |
| 711 1N...2N | 2-Insulated Phillips screwdriver |
| | PH.1 (80mmL); PH.2 (100mmL) |
| 713 024N...055N | 3-Insulated slotted screwdriver |
| | 2.5(75mmL); 4 (100mmL); 5.5 (125mmL) |

NEW



10pc Utility set

| | | |
|--------------|--------------|-------|
| 51015 | | |
| Part no. | 6/13/14/1.6' | 2167g |

| | |
|---------|--|
| 66301 | Contents: |
| 66301-B | 1-Super heavy-duty hacksaw |
| 6981250 | 2-Saw blade |
| 5096P8 | 1-Aviation tin snips - Straight cut |
| 5055P4 | 1-Measuring tape 5M |
| 5096P2 | 1-Utility knife (3pcs blade incl.) |
| 5096P2 | 1-Auto center punch |
| 5096P3 | 1-Stainless steel straight ruler 30CM |
| 87901 | 1-Scriber of wolfram steel (incl. one tungsten lead & one carbon lead) |
| 9U3003 | 1-Wire brush |

NEW



10pc Insulated pliers and screwdriver set

| | | |
|--------------|-----------------|-------|
| 51016 | | |
| Part no. | 3/9.1/10.1/1.5' | 3030g |

| | |
|-----------------|------------------------------------|
| 6903200 | Contents: |
| 6904200 | 1-Insulated combination pliers 8" |
| 6911200 | 1-Insulated long nose pliers 8" |
| 6805 | 1-Insulated diagonal pliers 8" |
| 711 1N...2N | 1-Heavy duty stripper pliers 8.3" |
| 713 024N...055N | 2-Insulated Phillips screwdriver |
| | PH.1(80mmL); PH.2(100mmL) |
| 2125P1 | 3-Insulated slotted screwdriver |
| | 2.5(75mmL); 4(100mmL); 5.5(125mmL) |
| | 1-Induction circuit tester |

NEW





11pc Pliers & screwdriver set

| | | |
|--------------|-----------------|-------|
| 51112 | | |
| Part no. | 3/9.5/10.5/1.5' | 3170g |

| | |
|---------------|--|
| 610B160 | Contents: |
| 611B175 | 1-Long nose pliers 6" |
| 612B160 | 1-Combination pliers 7" |
| 613B250 | 1-Diagonal pliers 6" |
| 711 1B...2B | 1-Waterpump pliers 10" |
| 713 04B...08B | 2-Phillips screwdriver |
| | PH.1(80mmL); PH.2(100mmL) |
| 88601 | 4-Slotted screwdriver |
| | 4(100mmL); 5.5(125mmL); 6.5(150mmL); 8(175mmL) |
| | 1-Demagnetizer / Magnetizer |



12pc Auto kit set



| | | |
|-------------|---|---|
| 5122 |  |  |
| Part no. | 6/13.0/14.0/0.9' | 2160g |

Content:

| | |
|-------------|---|
| 5061-1 | 6-Fill/Drain plug key |
| 5061-2 | 5/16"Hex - 3/8" Hex |
| 5061-3 | 8mmSq. - 3/8"Sq. |
| 5061-4 | 11mmSq. - 12mmHex |
| 5061-5 | 13mmSq. - 14mmHex |
| 5061-6 | 17mmHex - 1/2"Hex |
| 8074 | 8mmHex - 10mmHex |
| 16M...20.6M | 2-1/2"DR. Magnetic spark plug socket 16mm; 20.6mm |
| 810421 | 1-Plug key holder 1/2"(F)x21mm(F) |
| 617 | 1-Telescope mirror stick/magnetic pick-up |
| 618 | 1-20pc feeler gauges 0.05mm to 1mm |
| 619 | 1-Oil filter strap wrench |



13pc Chisel & punch set

| | | |
|-------------|---|---|
| 5131 |  |  |
| Part no. | 6/13.0/14.0/0.9' | 2167g |

Content:

| | |
|-----------------|---|
| 602 | 5-Chisel |
| 10150...22200 | 10 (150mmL); 12 (150mmL); 15 (180mmL); 19 (200mmL); 22 (200mmL) |
| 603150 | 1- Cape chisel 150mmL |
| 604 2140...4190 | 3- Pin punch |
| | 2 (140mmL); 3 (150mmL); 4 (190mm) |
| 606 2185...4185 | 3- Taper punch |
| | 2 (185mmL); 3 (185mmL); 4 (185mmL) |
| 6074185 | 1- Center punch 4 (185mmL) |



17pc Impact driver set

| | | |
|-------------|---|---|
| 5171 |  |  |
| Part no. | 20/22.0/23.0/0.82' | 1100g |

| | |
|---------------|--------------------------------------|
| 8174 | Content: 1/2" DR. 1-Impact driver |
| 15136 2...3 | 14-5/16" bit |
| 15236 2...3 | Phillips PH.2; PH.3 (36mmL) |
| 15336 09...11 | Pozidriv PZ.2; PZ.3 (36mmL) |
| 15635 25...50 | Slotted 9; 11 mm (36mmL) |
| | Star T25; T30; T40; T45; T50 (35mmL) |
| 15436 06...10 | Hex 6; 8; 10 mm (36mmL) |
| 81045A | 1-Impact bit holder 1/2"DR.x5/16" |
| 8095330 | 1-Bit adaptor 5/16"Hex-3/8"Sq. |

NEW



33pc Utility tools

| | | |
|-------------|---|---|
| 5333 |  |  |
| Part no. | 3/12.9/13.9/1.5' | 4300g |

| | |
|-----------------|--|
| 753 08...17 | Content: 1/2" DR. 4-Angle wrench 6pt.-6pt. 8; 10; 13; 17 mm |
| 754 0608...1719 | 4-Double open end wrench |
| 611B175 | 6x8; 10x11; 12x13; 17x19 mm |
| 612B175 | 1-Combination pliers 7" |
| 616300 | 1-Diagonal pliers 7" |
| 61910 | 1-Engineer hammer 300g |
| 649200A | 1-Oil filter wrench 65-110mm |
| 7112S | 1-Adjustable gauged wrench 8" |
| 71304 | 1-Stubby Phillips screwdriver PH.2(25mmL) |
| 5093 | 1-Slotted screwdriver 4mm(100mmL) |
| 764 015...10 | 9-Hex key |
| 5098 | 1.5; 2; 2.5; 3; 4; 5; 6; 8; 10 mm |
| 766 10...50 | 9-Star key set |
| | T10; T15; T20; T25; T27; T30; T40; T45; T50 |



20pc Star screw measure set

| | | |
|-------------|-----------------|-----|
| 5201 | | |
| Part no. | 60/4.0/5.0/2.6' | 66g |

Help select the correct Torx sizes of bit or socket

Content:
20-Star screw measure
E1xT5; E2xT6; E4xT7; E5xT8; E6xT9; E7xT10;
E8xT15; E10xT20; E11xT25; E12xT27; E14xT30;
E16xT35; E18xT40; E20xT45; E22xT47; E24xT50;
E26xT55; E28xT60; E30xT70; E32xT80

NEW



86pc Grade nut fastener set

| | | |
|-------------|----------------|------|
| 5861 | | |
| Part no. | 6/5.8/6.8/0.9' | 960g |

| | |
|---------|---|
| 67802 | Contents: 1-Grade nut fastener (include 1pc M6x1.0 screw) 3-Screw |
| 5861-M3 | M3x0.5 |
| 5861-M4 | M4x0.7 |
| 5861-M5 | M5x0.8 |
| 5861-S | 1-Spanner |
| 5861-1 | 20-Instant blind nut 5.1mm |
| 5861-2 | 20-Instant blind nut 6.1mm |
| 5861-3 | 20-Instant blind nut 7.1mm |
| 5861-4 | 20-Instant blind nut 9.1mm |

NEW



Multi-function inspection tool

| | | |
|-------------|-------------------|------|
| 617A | | |
| Part no. | 40/21.6/22.6/0.8' | 539g |

1pc Aluminium interchangeable handle
1pc Inspection mirror
1pc 6-lbs Magnetic retriever
1pc 10" Flexible adapter
1pc 9" 135 degree bended adapter
1pc 8" Straight adapter
1pc UV light
1pc LED light

NEW



3pc Torque multiplier set

| | | |
|-------------|------------------|-------|
| 6031 | | |
| Part no. | 3/10.5/11.5/1.2' | 3500g |

Contents:
2-Torque multiplier head & 380mm reaction bar
3/4"(F)x1"(M) Max output 2500Nm
1-3/4"DR. Sliding T handle 20"

NEW



3pc Torque multiplier set

| | | |
|-------------|------------------|-------|
| 6032 | | |
| Part no. | 3/10.5/11.5/1.2' | 3500g |

Contents:
2-Torque multiplier head & 380mm reaction bar
3/4"(F)x1"(M) Max output 2500Nm
1-3/4"DR. Ratchet handle 20"



Piston ring compressor

| | | |
|--------------|------------------|-------|
| 62001 | | |
| Part no. | 8/12.2/13.2/1.8' | 3125g |

* Install pistons from 2-7/8" to 4-3/8" (73-111mm)
* Ratcheting lock allows the bands to compress in small increments.
* Can be used parallel vertically perpendicular horizontally.
* Set includes pliers and 6 bands.
* Contents :
1pc Ratchet pliers
1pc Band size 2-7/8" to 3-1/8"
1pc Band size 3-1/8" to 3-3/8"
1pc Band size 3-3/8" to 3-5/8"
1pc Band size 3-5/8" to 3-7/8"
1pc Band size 3-7/8" to 4-1/8"
1pc Band size 4-1/8" to 4-3/8"



Valve spring compressor

| | | |
|--------------|----------------|-------|
| 62105 | | |
| Part no. | 5/19.0/20.0/2' | 3800g |

Universal overhead cam Applying for most popular cars engines, including AUDI, CHRYSLER, INFINITI, HONDA, HYUNDAI, LEXUS, MAZDA, MITSUBISHI, NISSAN, PORSCHE, SATURN, TOYOTA, VOLVO and VOLKSWAGEN.

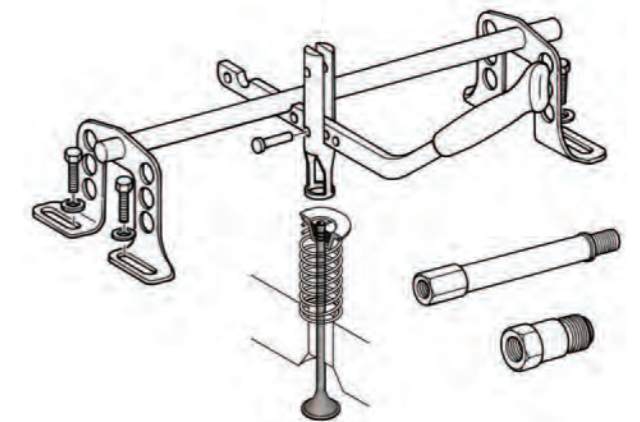



Universal strut spring compressor

| | | |
|--------------|------------------|-------|
| 62702 | | |
| Part no. | 2/18.7/19.7/1.5' | 9350g |

- * This tool fits a wide range of struts without the inconvenience of special adaptor shoes.
- * Tool compresses springs of 4" to 8" OD. with wire diameters of 7/16" to 11/16". Works both by hand or impact wrench.
- * The jaws of the compressor are held in place by safety locking pins.
- * Use most of spring compressor quickly and easily on the bench or on the vehicle.

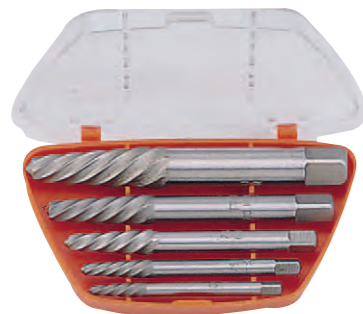

5pc Screw extractor set

| | | |
|--------------|--------------------|------|
| 63005 | | |
| Part no. | 100/13.4/14.4/1.4' | 134g |

Content:
7/64"; 9/64"; 5/32"; 1/4"; 19/64"



8pc Screw extractor set

| | | |
|-------------------------|--------------------|------|
| 63006&63006B | | |
| Part no. | 24/19.9/20.9/0.79' | 830g |

| | |
|--------|---|
| 63006 | 5/64"; 7/64"; 5/32"; 1/4"; 19/64"; 13/32"; 17/32"; 13/16" |
| 63006B | 5/64"; 7/64"; 5/32"; 1/4"; 19/64"; 13/32"; 17/32"; 13/16"(CR-MO) |



5pc Spark plug rethreader set

| | | |
|--------------|--------------------|------|
| 64101 | | |
| Part no. | 72/12.0/13.0/0.75' | 166g |

Content:
1pc 14mm Spark plug rethreader
4pc inserts 3/8"; 7/16"; 1/2"; 3/4" long

- * Repairing stripped or damaged threads in aluminum cylinder heads.
- * Solid steel inserts replace damaged threads.



11pc Torque wrench set

| | | |
|---------------|--------------------|-------|
| 64701L | | |
| Part no. | 12/20.4/21.4/0.85' | 1700g |

| | |
|----------------|--|
| 6473380 | Content: 3/8" DR. 1- 3/8"DR. Lock torque wrench |
| 535 10...21 | 6- 3/8"DR. 6pt. Flank socket 10; 12; 14; 17; 19; 21mm |
| 334050 04...08 | 4- 3/8"DR. Hex socket bit 4; 5; 6; 8mm (50mmL) |



11pc Torque wrench set

| | | |
|---------------|--------------------|-------|
| 64702L | | |
| Part no. | 12/20.4/21.4/0.85' | 1700g |

| | |
|----------------|---|
| 6474535 | Content: 1/2" DR. 1- 1/2"DR. Lock torque wrench |
| 545 17...27 | 6- 1/2"DR. 6pt. Flank socket 17; 19; 21; 22; 24; 27 mm |
| 344055 06...12 | 4- 1/2"DR. Hex socket bit 6; 8; 10; 12 mm (50mmL) |



2pc Torque driver set

| | | |
|--------------|-------------------|------|
| 64703 | | |
| Part no. | 40/15.2/16.2/0.5' | 380g |

| | |
|---------|---|
| 6472150 | Content: 1/4" DR. 1- 1/4"DR. Torque driver |
| 81022 | 1- Bit holder 1/4"(F)x1/4" inhex |



8pc Head-interchangeable torque wrench & spanner set

| | | |
|--------------|------------------|-------|
| 64704 | | |
| Part no. | 6/19.5/20.5/1.2' | 3250g |

| | |
|---------------|---|
| 647B080 | Content: 1- 15~80Nm Torque wrench |
| 647H414A | 1- 1/2"DR. Ratchet head (small width 36mm) |
| 68514 17...29 | 6- Spanner head 17; 22; 24; 26; 27; 29 mm |



11pc Head-interchangeable torque wrench & spanner set

| | | |
|--------------|-------------------|-------|
| 64705 | | |
| Part no. | 4/17.9/18.9/0.96' | 4470g |

| | |
|---------------|--|
| 647B210 | Content: 1- 40~210Nm Torque wrench |
| 647H414 | 1- 1/2"DR. Ratchet head |
| 68514 13...30 | 9- Spanner head 13; 14; 15; 17; 19; 22; 24; 27; 30 mm |



9pc Head-interchangeable torque wrench & spanner set

| | | |
|--------------|---|--------|
| 64709 | | |
| Part no. | 1/12.4/13.4/0.85' | 12.4kg |
| 647B210 | 40~210Nm Torque wrench (14x18) Ø 43, 60, 72, 50, 63.2, 82, 32 mm | |



11pc Head-interchangeable torque wrench & spanner set

| | | |
|--------------------|---|--------|
| 64710 | | |
| Part no. | 10/15.2/15.8/1.29' | 1.52kg |
| 647B030 647H209 | 6~30 Nm Torque wrench 1/4" DR. 9 X 12 Ratchet head 9 X 12 Spanner head 7, 8, 9, 10, 11, 12, 13, 14mm | |



13pc Head-interchangeable torque wrench & spanner set

| | | |
|--------------------|---|--------|
| 64711 | | |
| Part no. | 10/21.6/22.4/1.68' | 2.16kg |
| 647B110 647H309 | 19~110 Nm Torque wrench 3/8" DR. 9 X 12 Ratchet head 9 X 12 Spanner head: 10, 11, 12, 13, 14, 15, 16, 17, 18, 19mm | |



12pc Head-interchangeable torque wrench & spanner set

| | | |
|--------------------|--|------|
| 64712 | | |
| Part no. | 30/23.0/24.0/0.74' | 765g |
| 647B015 647H209 | 3~15 Nm Torque wrench 1/4" DR. 9 X 12 Ratchet head 9 X 12 Spanner head: 5.1mm, 5.8mm, 6.1mm, 6.3mm, 6.4mm, 6.5mm, 6.7mm, 6.9mm; 6 PT. Spline | |



11pc Head-interchangeable torque wrench & spanner set

| | | |
|----------------------|---|--------|
| 64713 | | |
| Part no. | 10/15.2/16.2/1.29' | 1.52kg |
| 647B030W 647H309A | 6~30 Nm Torque wrench 3/8" DR. 9 X 12 Ratchet head 9 X 12 Spanner head (small width 27mm) 7, 8, 9, 10, 11, 12, 13, 14mm | |



13pc Head-interchangeable torque wrench & spanner set

| | | |
|---------------------|--|--------|
| 64714 | | |
| Part no. | 10/18.1/18.7/1.68' | 1.81kg |
| 647B060W 647H409 | 10~60 Nm Torque wrench 1/2" DR. 9 X 12 Ratchet head 9 X 12 Spanner head: 10, 11, 12, 13, 14, 15, 16, 17, 18, 19mm | |



13pc Head-interchangeable torque wrench & spanner set

| | | |
|---------------------|--|--------|
| 64715 | | |
| Part no. | 10/21.6/22.4/1.68' | 2.16kg |
| 647B100W 647H409 | 20~100 Nm Torque wrench 1/2" DR. 9 X 12 Ratchet head 9 X 12 Spanner head: 10, 11, 12, 13, 14, 15, 16, 17, 18, 19mm | |



47pc Torque driver set

| | | |
|---|---|------|
| K64706 | | |
| Part no. | 24/21.7/22.7/1.5' | 905g |
| 6472150 81022 8042100 12125 0...3 12223 0...3 12325 03...065 12425 015...06 124R25 1...3 12625 06...40 12725 06...40 | Content: 1/4"DR. 1- Torque driver 1- Bit holder 1/4"(F)x1/4"inhex 1- Extension 4" 4- Phillips bit (25mmL) PH.0; PH.1; PH.2; PH.3 4- Pozidriv bit (25mmL) PZ.0; PZ.1; PZ.2; PZ.3 5- Slotted bit 3; 4; 5; 5.5; 6.5 mm 6- Hex bit 1.5; 2; 3; 4; 5; 6 mm 3- Square bit 1; 2; 3 mm 11-Star bit T6; T7; T8; T9; T10; T15; T20; T25; T27; T30; T40 11-Star tamperproof bit T-6H; T-7H; T-8H; T-9H; T-10H; T-15H; T-20H; T-25H; T-27H; T-30H; T-40H | |

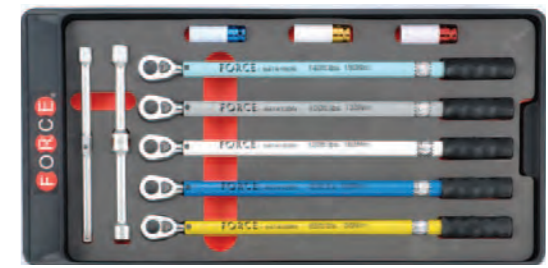

9pc Wheel specialized torque tool set

| | | |
|--|--|--------|
| 64707 | | |
| Part no. | 1/12.4/13.4/0.85' | 12.4kg |
| 6474 088N...190N 44585 17C...21C 681A300 | Content: 1/2" DR. 5- Torque wrench 88; 108; 135; 163; 190 Nm 3- Wheel nut 6pt. flank impact socket (85mmL) 17; 19; 21 mm 1- Assembly wheel nut wrench 17; 19; 13/16"; 1/2"DR. (300mmL) | |



Tubing cutter and double flaring tools kit

| | | |
|--|-------------------|-------|
| 656 | | |
| Part no. | 10/18.0/19.0/1.8' | 1800g |
| Content: 1pc Tubing cutter. 1pc 9/16" Screen bar. 7pc Adaptor 3/16"; 1/4"; 5/16"; 3/8"; 7/16"; 1/2"; 5/8" | | |

Tubing cutter and double flaring tools kit (Metric)

| | | |
|--|-----------------|-------|
| 656M | | |
| Part no. | 10/17.2/18.2/1' | 1720g |
| Content: 1pc Tubing cutter. 1pc 9/16" Screen bar. 7pc Adaptor 4; 6; 8; 10; 12; 14; 16 mm(5/8") | | |

NEW



Hydraulic flaring tool kits

| | | |
|-------------|--------------|-------|
| 656B | | |
| Part no. | 6/15/16/1.5' | 2330g |

*SAE:3/16".1/4"
*DIN:3/16".1/4"



Brake caliper piston tools

| | | |
|------------|-------------------|-------|
| 658 | | |
| Part no. | 12/17.0/18.0/1.3' | 1416g |

* Application: FORD, ROVER, HONDA, MERCEDES, TOYOTA, VW, AUDI, NISSAN, BMW, MAZDA, MITSUBISHI, PEUGEOT, SUBARU
* Kit comprises main body, screw assembly, special locating plate and 5 adaptors covering wind-back.



Slide hammer puller set

| | | |
|------------|------------------|-------|
| 664 | | |
| Part no. | 2/13.0/14.0/1.6' | 6500g |

- Content:
- * 1pc T bar
 - * 1pc Hammer (5 lbs.)
 - * 1pc High axle puller
 - * 1pc Low axle puller
 - * 1pc Grip wrench adaptor
 - * 1pc Nut
 - * 1pc 2 Jaw head
 - * 1pc 3 Jaw head
 - * 3pc Screw & nut
 - * 1pc Attachment
 - * 3pc Jaw
 - * 1pc Tapping screw
 - * 1pc Hook



Locking jaw puller set

| | | |
|-------------|-------------------|-------|
| 664P | | |
| Part no. | 6/13.5/14.5/1.33' | 2250g |

The set has several pulling attachments to give the user various methods for pulling, maintenance and repair applications.

- Content:
- * 9pc Adjustable reversible jaw
 - * 1pc Forcing screw
 - * 1pc Two-way yoke
 - * 1pc Three-way yoke
 - * 1pc Reversible adjusting nut
 - * 3pc Screw & nut



Slide hammer puller set

| | | |
|-------------|------------------|-------|
| 664A | | |
| Part no. | 2/19.0/20.0/2.1' | 9488g |

Slide hammer puller set has several pulling attachments to give the user various methods for pulling, maintenance and repair applications; the slide hammer exerts force when needed.

- Content:
- * 9pc Adjustable reversible jaw
 - * 1pc Forcing screw
 - * 1pc Two-way yoke
 - * 1pc Three-way yoke
 - * 1pc Reversible adjusting nut
 - * 3pc Screw & nut
 - * 1pc Handle rod
 - * 1pc Hammer (5 lbs.)
 - * 1pc High axle puller
 - * 1pc Low axle puller
 - * 1pc Inside hook jaw
 - * 1pc Pivot pin
 - * 1pc Hexagon screw
 - * 1pc Attachment
 - * 1pc Tapping screw
 - * 1pc Nut



10LBS 9pc Dent puller set

| | | |
|-------------|------------------|-------|
| 665B | | |
| Part no. | 2/16.8/17.8/0.9' | 8420g |

- Content:
- * 1pc Pipe (Diameter 22.5mm x 590mmL)
 - * 1pc Pipe (Diameter 22.5mm x 200mmL)
 - * 1pc 2 Hole pipe (Diameter 29mm x 40mmL)
 - * 1pc Hammer (10lbs.)
 - * 1pc Plate (6mm x 170mm) / 1pc Plate (6mm x 120mm)
 - * 1pc Plate (6mm x 120mm) / 1pc Plate (6mm x 200mm)
 - * 1pc Plate (3mm x 100mm)
 - * 1pc Chain & hook
 - * 1pc Hex nut (29mm)



Hydraulic bearing separator puller set

| | | |
|--------------|-------------------|-------|
| 66601 | | |
| Part no. | 2/17.0/18.0/0.51' | 8.5kg |

- Content:
- * 1pc Hydraulic ram (SCM415 Diameter 37.7mm x 160mmL x 16t)
 - * 1set Bearing separator & bolts, SCM415, capacity 75-105mm
 - * 2pc Main rod (8"x1.75p)
 - * 2pc Extension rod (8"x1.75p)
 - * 1pc Beam

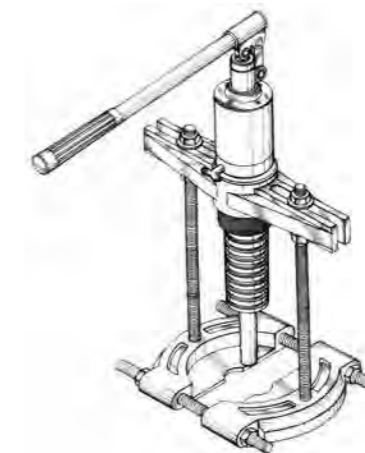

Hydraulic bearing separator puller set

| | | | | | |
|------------|----------|-----------|------------|--------|----|
| 666 | | | | | |
| Part no. | Capacity | Reach(mm) | Spread(mm) | Stroke | kg |
| 66605 | 6 tons | 300/190 | 235/210 | 82 | 16 |
| 66606 | 8 tons | 300/245 | 235/220 | 82 | 17 |
| 66607 | 10 tons | 330/220 | 235/210 | 82 | 16 |
| 66608 | 12 tons | 330/275 | 235/220 | 82 | 17 |



NEW



NEW



NEW



Pressure screw separator puller set

| | | |
|--------------|----------------|-------|
| 66602 | | |
| Part no. | 2/15.0/16.0/1' | 7.5kg |

- Content:
- 1pc Central bolt
 - 1set Bearing separator & bolts, SCM415, capacity 75-105mm
 - 2pc Main rod (8"x1.75p)
 - 2pc Extension rod (8"x1.75p)
 - 1pc Beam
 - 1pc Nut

Two sets bearing separator kit

| | | |
|--------------|------------------|-------|
| 66610 | | |
| Part no. | 5/23.0/24.0/1.8' | 4.6kg |

- *2 sets Bearing separator & bolts (SCM415 Drop forged HRC 42-45)
Capacity: 30-50mm
Capacity: 50-75mm
- *4pc Main/Extension rod (Hex bar 17mm x 127mmL x 3/8" - 16T)
- *4pc Main/Extension rod (Hex bar 14mm x 102mmL x 3/8" - 16T)
- *1pc Beam (S45C)
- *1pc Forcing screw (Φ9/16" - 10T/inch x 175mmL S45C)
- *Packing: Blow mold case

Hydraulic bearing separator puller set

| | | |
|--------------|------------------|------|
| 66613 | | |
| Part no. | 2/24.0/25.0/0.8' | 12kg |

- *1pc Hydraulic Ram (SCM420 Φ37.7mm)
- *1 set Bearing separator & bolts (SCM415 Drop forged HRC 42-45)
Capacity: 105-150mm
- *2pc Main rod (Hex bar 21mm x 10"L x Φ5/8" - 11 NC)
- *2pc Extension rod (Hex bar 21mm x 10"L x Φ5/8" - 11 NC)
- *1pc Beam (Ductile)
- *1pc Adaptor (Carbon steel)
- *Packing: Metal case

Pilot bearing puller

| | | |
|--------------|-----------------|------|
| 66619 | | |
| Part no. | 20/18.3/19/0.8' | 920g |

- * Capacity: inside diameter 12mm-38mm, 1/2"~1-1/2"



Bearing race and seal driver set

| | | |
|--------------|-------------------|-------|
| 66603 | | |
| Part no. | 12/20.6/21.6/1.9' | 1790g |

Makes it easier to insert wheel bearing race and seals without damage to race and axle housing. The set includes 9 disc sizes to fit most standard wheel bearing. Turn discs over to drive seals.

NEW



Pressure screw separator puller set

| | | |
|--------------|------------------|-----|
| 66612 | | |
| Part no. | 2/18.0/19.0/0.5' | 9kg |

- *1 set Bearing separator & bolts (SCM415 Drop forged HRC 42-45)
Capacity: 75-105mm
- *2pc Main rod (Hex bar 19mm x 8"L x Φ15.24mm - 1.75P)
- *2pc Extension rod (Hex bar 19mm x 8"L x Φ15.24mm - 1.75P)
- *1pc Beam (S45C)
- *1pc Forcing screw (Φ18.65 - 10T/inch x 292mmL S45C)
- *1pc Central nut
- *Packing: Metal case

NEW



Bearing separator

| | | |
|--------------|-------------------|------|
| 66618 | | |
| Part no. | 20/17.0/18.0/1.5' | 800g |

- * This kit is different from other bearing separators. When obstruction is round external dia. and internal dia. of bearing, it can be used on the confined space to damage the protecting cover of bearing and easily remove bearings.
- * Adjust range: 20 ~ 95 mm
- * Bearing range: 6004 ~ 6010 (Jaw size: Ø 6 / 8) ; 6201 ~ 6206 (Jaw size: Ø 5.5 / 6 / 8) ; 6300 ~ 6304 (Jaw size: Ø 6 / 8)

NEW



2-in-1 Bearing Puller (3 Jaws)

| | | |
|--------------|-------------------|-------|
| 66620 | | |
| Part no. | 4/12.4/13.4/1.17' | 3050g |

- * Inside diameter 12mm ~38mm

NEW



2-in-1 Bearing Puller (2 Jaws)

| | | |
|--------------|-------------------|-------|
| 66621 | | |
| Part no. | 2/10.7/11.7/0.62' | 5400g |

* Inside diameter 38mm ~120mm

NEW



Universal puller set

| | | |
|--------------|-------------------|--------|
| 66627 | | |
| Part no. | 2/25.0/26.0/1.25' | 12.4kg |

- * 1 beam 2-arm
- * 1 beam 3-arm
- * 9 pulling legs, length 150 / 220 / 300 mm
- * 1 spindle

NEW



Hydraulic gear puller set

| | | |
|--------------|------------------|--------|
| 66622 | | |
| Part no. | 1/16.5/17.5/1.2' | 16.5kg |

- * For agriculture/ Machine/ Garage/ Industry use
- * Hydraulic ram (SCM420 Ø37.7mm)
- * Twin Head 1pc
- * Triple head 1pc
- * Ram nut (SCM415 HRC 42-45)
- * Beam (S45C)
- * 4" Leg 3 pcs (SCM415 HRC 42-45)
- * 6" Leg 3 pcs (SCM415 HRC 42-45)
- * 8" Leg 3 pcs (SCM415 HRC 42-45)
- * Sent pop (Ø1" × L30mm S45C)
- * Ram extension rod (Ø1" × L2" S45C)
- * Ram extension rod (Ø1" × L2" S45C)
- * Main rod 2 pc (Hex bar 19mm × L8" × Ø15.24mm-1.75P)
- * Extension rod 2pc (Hex bar 19mm × L8" × Ø15.24mm-1.75P)
- * Bearing separator Spread range 75-150mm (SCM415 Drop forged HRC 42-45)

NEW



2&3 Jaws gear puller set

| | | |
|--------------|-------------------|--------|
| 66628 | | |
| Part no. | 6/16.5/17.5/0.93' | 12.4kg |

- * 1 beam with 2-arm and 3-arm
- * 6 pulling legs, length 130 / 200 mm
- * 1 spindle (219mm)



Differential side bearing puller

| | | |
|---------------|--------------------|-------|
| 666A01 | | |
| Part no. | 10/21.0/22.0/1.46' | 2100g |

- *Use to remove differential side carrier bearing. Works on a wide variety of cars and light-duty trucks.
- *Includes four step plate adapters to fit carrier bearings.



21pc Go-through ratchet socket set (SAE&MM)

| | | |
|---------------|------------------|-------|
| 666A03 | | |
| Part no. | 5/21.8/22.4/1.3' | 4360g |

- *For a wide range of pulling jobs, including: bearings, alternators, generators, power steering and crankshaft pulleys, timing gears, and harmonic balancers.
- *Spread: 2-3/8" to 3-3/8" & 3-1/2" to 5-1/2"
- *Reach: 1-5/8" & 1-3/4"
- *Set includes drop-forged components, which can be used in a variety of combinations.



A/C Clutch puller set

| | | |
|---------------|--------------------|-------|
| 666A02 | | |
| Part no. | 10/22.0/23.0/1.46' | 2200g |

- *Versatile 2-jaw puller designed to remove stubborn A/C clutch pulleys.
- *Features two sets of jaws, a crossbar with three settings for correct spread, and an adjustable yoke to keep jaws tight.
- * Spread of jaws: 3" to 5". Reach of jaws: 1" to 2-1/4".



Axle spindle rethreading set

| | | |
|--------------|-------------------|------|
| 67001 | | |
| Part no. | 36/21.0/22.0/1.8' | 583g |

- 8pcs thread restoring die set is used to clean or repair axle threads on spindles.
- Use with 1-1/4" socket or wrench.
- Size: M24x1.50; M24x2.00; M22x1.00; M22x1.50; M20x1.50; M20x1.25; 3/4"x20UNEF; 13/16"x20UNEF



4pc Nut splitter set

| | | |
|------------|------------------------------|-------|
| 672 | | |
| Part no. | 12/17.5/18.5/0.95' | 1250g |
| 6720912 | 1pc 5/16" to 1/2" (9-12mm) | |
| 6721216 | 1pc 1/2" to 5/8" (12-16mm) | |
| 6721622 | 1pc 5/8" to 7/8" (16-22mm) | |
| 6722227 | 1pc 7/8" to 1-1/8" (22-27mm) | |



VW, AUDI V-belt pulley remover

| | | |
|---|------------------|-----|
| 67402 | | |
| Part no. | 144/5.0/6.0/1.5' | 50g |
| <ul style="list-style-type: none"> * Special design to stop the pulley and remove the center bolts to remove the V-belt pulley at the generator. * Use with 17mm wrench. * Applicable: VW GOLF, VENTO, PASSAT, AUDI A3 and VOLVO | | |



2pc M10 Alternator tools

| | | |
|--|--------------------|------------|
| 674 | | |
| Part no. | 100/21.2/22.2/1.5' | 110mm 212g |
| <ul style="list-style-type: none"> * 1pc 1/2"DR. Spline (XZN) socket bit M10x110mmL * 1pc Reaction corkscrew cap 33 teeth-Ø19mm-17mm hex * Application : VW-Audi, Skoda, Porsche, BMW, Ford, Mercedes-Benz etc. | | |



2pc T50 Alternator tools

| | | |
|--|--------------------|------------|
| 678 | | |
| Part no. | 100/21.2/22.2/1.5' | 110mm 212g |
| <ul style="list-style-type: none"> * 1pc 1/2"DR. Torx socket bit T50x110mmL * 1pc Reaction corkscrew cap 33 teeth-Ø19mm-17mm hex * Application: Mercedes A Class. | | |



4pc Jumbo heavy duty pry bar set

| | | |
|---|------------------|-------|
| 904U2 | | |
| Part no. | 2/17.5/18.5/1.4' | 8730g |
| <ul style="list-style-type: none"> * Extra large handles allow use of both hands for increased leverage * Textured handle grips for secure hold * Chrome Molybdenum steel shafts * Hardened and tempered for maximum strength * Heavy duty 5/8" bar stock * Go-thru shafts with steel end caps * Sizes : 24" x 45°; 24" x 90°; 36" x 45°; 36" straight | | |

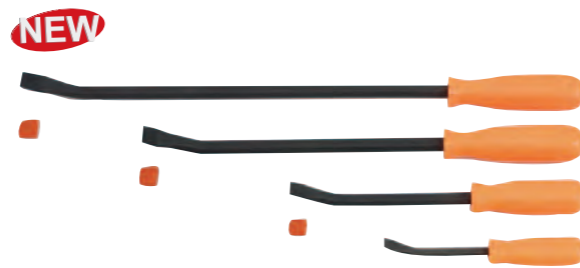

4pc Pry bar set

| | | |
|-------------------------|-------------------|--------|
| 904U5 | | |
| Part no. | 12/17.0/18.0/1.5' | 14 20g |
| Size: 8"; 12"; 18"; 24" | | |

NEW



4pc Pry bar set

| | | |
|---|-------------------|-------|
| 904U6 | | |
| Part no. | 10/17.0/18.0/1.1' | 1700g |
| <ul style="list-style-type: none"> 904U606 1-6" Pry bar 904U612 1-12" Pry bar 904U616 1-16" Pry bar 904U620 1-20" Pry bar | | |



6pc Chisel & punch set (long type, interchangeable)

| | | |
|--|-------------------|------|
| 906U1 | | |
| Part no. | 36/25.5/26.5/2.2' | 710g |
| <ul style="list-style-type: none"> Contents: 1pc Main handle, 1pc Flat chisel 13mm, 1pc Center punch 3mm, 3pc Pin punch 3; 4; 5mm * Material and shape: Main handle made by carbon steel; Bits made by Chrome-Vanadium. All shank 10mm hex with two grooves. * Comfortable and protective handle * Double locking device holding tight * Save space, time and money * Create high efficiency * WARNING: Wear safety goggles when in use; Chisel and punch shanks have to be inserted to hole bottom. | | |

NEW



5pc Auto body tools

| | | |
|--|----------------|------|
| 905M2 | | |
| Part no. | 6/5.0/6.0/0.9' | 836g |
| <ul style="list-style-type: none"> 905M2P1 1-Trim pad remover (big) 905M2P2 1-Trim pad remover (small) 905M2P3 1-Gasket scraper 905M2P4 1-Radiator hose remover 905M2P5 1-Cotter pin puller | | |



10pc Impact socket set (3/8" DR.)

| | | |
|---|-------------------|------|
| 910U2 | | |
| Part no. | 28/18.9/19.9/1.8' | 675g |
| <ul style="list-style-type: none"> Contents: 9pc impact socket : mm(inches) 10; 11; 12; 13; 14; 15; 16(5/8"); 17; 19(3/4") 1pc 8mm Straight rod Features: 1. This impact socket set is a tool and it is specially designed for loosening a nut which can not be done by a socket or wrench. 2. This tool is only useful for a nut with positive threads. 3. This tool can also be used while a nut could not be loosened in a normal way because of rust and deformation. 4. This socket set is made of AISI4340 with HRC52-55 hardness. | | |



Piston ring service tool set

| | | |
|--------------|---|---|
| 911G3 |  |  |
| Part no. | 6/15.5/16.5/2.9' | 2583g |

- * Piston ring compressor w/ratchet key
H:3"(53-125mm), H:3-1/2"(90-175mm),
H:4"(90-175mm)
- * Piston ring tool capacity: 50-100mm
- * Piston ring groove cleaning
Fits: 2"-5"(51 to 127mm)
Blade 1 size: 1/16" to 3/16"
Blade 2 size: 2.0mm to 4.5mm, 1/4"
Blade 3 size: 1.2mm to 5.5mm
- * Offset screwdrivers:



11pc Auto body repair set (Interchangeable)

| | | |
|--------------|---|---|
| 911M1 |  |  |
| Part no. | 10/23.0/24.5/1.8' | 2300g |

- Contents:
- 1pc Head-interchangeable hammer
 - 1pc Multi Dolly
 - 1pc Cross curve
 - 1pc Ball peen
 - 1pc Ball type
 - 1pc End small curve
 - 1pc Angel groove
 - 1pc Round face
 - 1pc Square face
 - 1pc Multi curve
- * Material: Main hammer made from drop forged tool steel; All bits made from Chrome-Vanadium
 - * Double locking device holding tight
 - * Save space/weight
 - * Save money/time
 - * Create high efficiency
 - * Warning: Form hitter bits shank has to insert to hole's bottom.



12pc Internal-external circlip pliers set

| | | |
|--------------|---|---|
| 912U1 |  |  |
| Part no. | 6/19.8/20.8/2.3' | 3300g |

- * Feature replaceable points and spring ratchet locking mechanism to securely hold against circlip tension.
Internal: 3-1/16" - 6-1/4"
External: 3-1/2" - 6-1/2"
- * Tip Diameter: 0.12" (3mm)
Spread: 3-1/4" (85mm)
Length: 16" (400mm)



12pc Chisel & punch set (interchangeable)

| | | |
|--------------|---|---|
| 912U2 |  |  |
| Part no. | 20/24.0/25.5/2.4' | 1200g |

- Contents:
- 1pc Main handle
 - 2pc Flat chisel 10; 13mm (width of blade)
 - 1pc Cape chisel 4mm (width of blade)
 - 3pc Taper punch 2; 3; 4 mm
 - 3pc Pin punch 3; 4; 5 mm
 - 2pc Center punch 0; 3 mm
- * WARNING: Wear safety goggles when in use; Chisel and punch shanks have to be inserted to hole bottom.

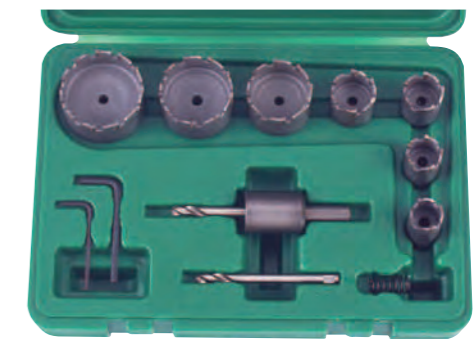

13pc Tungsten carbide tipped metal borer set

| | | |
|--------------|---|---|
| 913U1 |  |  |
| Part no. | 10/15.7/16.7/1.4' | 1570g |

- * Use the same arbor for saw heads of different sizes.
- * Change saw heads with a simple push and turn the fixed screw.
- * H.S.S. center drill is replaceable.
- * Shank size of the arbor is 3/8".
- * Spring can help slug removal.

- Content:
- 7pc Saw head
19; 22; 25; 28; 30; 32; 35 mm
 - 1pc Arbor
 - 1pc Spring
 - 2pc H.S.S center pilot drill 75; 84 mm
 - 2pc Hex key 2.5; 4.0 mm

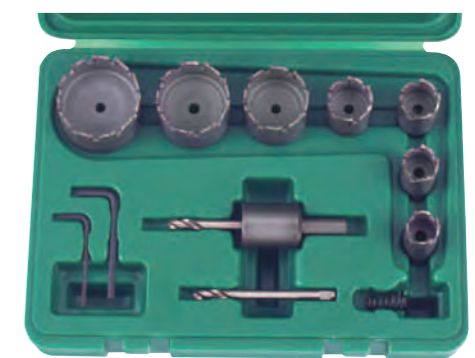

13pc Tungsten carbide tipped metal borer set

| | | |
|--------------|---|---|
| 913U2 |  |  |
| Part no. | 10/15.7/16.7/1.4' | 1570g |

- * Use the same arbor for saw heads of different sizes.
- * Change saw heads with a simple push and turn the fixed screw.
- * H.S.S. center drill is replaceable.
- * Shank size of the arbor is 3/8".
- * Spring can help slug removal.

- Content:
- 7pc Saw head
30; 32; 35; 38; 40; 45; 51 mm
 - 1pc Arbor
 - 1pc Spring
 - 2pc H.S.S center pilot drill 75; 84 mm
 - 2pc Hex key 2.5; 4.0 mm



15pc Chisel & punch set (interchangeable)

| | | |
|--------------|---|---|
| 915U3 |  |  |
| Part no. | 10/22.5/23.5/1.8' | 2250g |

CONTENTS:

- 1pc Main handle
- 5pc Flat chisel 13; 16; 19; 22; 25 mm (width of blade)
- 1pc Cape chisel 6mm (width of blade)
- 2pc Taper punch 3; 6 mm
- 2pc Pin punch 5; 6 mm
- 1pc Center punch 5 mm
- 1pc Point chisel
- 1pc Flat blade 60mm
- 1pc Curve blade 40mm
- * Material and shape: Main handle made from Chrome-Molybdenum; Bits made by Chrome-Vanadium.
- All shank 13mm hex with two grooves.
- * Comfortable and protective handle
- * Double locking device holding tight
- * Save weight, space, time and money
- * Create high efficiency
- WARNING:** Wear safety goggles when in use; Chisel and punch shanks have to be inserted to hole bottom.



15pc Hammer chisel & punch set (interchangeable)



| | | |
|--------------|---|---|
| 915U4 |  |  |
| Part no. | 10/24.0/25.5/2.4' | 2400g |

CONTENTS:

- 1pc Head-interchangeable hammer
- 5pc Flat chisel 13; 16; 19; 22; 25 mm
- 1pc Cape chisel 6mm
- 2pc Taper punch 3; 6 mm
- 2pc Pin punch 5; 6 mm
- 1pc Center punch 5 mm
- 1pc Flat blade 60mm
- 1pc Curve blade 40mm
- 1pc Point chisel
- * Material: Main hammer made from drop forged carbon steel; Bits made by Chrome-Vanadium.
- * Safe and comfortable handle of hammer.
- * Double locking device holding tight
- * Save weight, space, time and money
- * Create high efficiency
- WARNING:** Wear safety goggles when in use; Chisel and punch shanks have to be inserted to hole bottom.





Chisel

| | | | | |
|------------|------|----------|---|---|
| 602 | | <i>l</i> |  |  |
| Part no. | size | mm | g | pc/box |
| 60210150 | 10 | 150 | 83 | 10 |
| 60212150 | 12 | 150 | 89 | 10 |
| 60215180 | 15 | 180 | 152 | 10 |
| 60219200 | 19 | 200 | 293 | 10 |
| 60222200 | 22 | 200 | 302 | 5 |
| 60225220 | 25 | 220 | 415 | 5 |

NEW





Ribbed (Cold) chisel

| | | | | |
|----------------|------|----------|---|---|
| 602...C | Size | <i>l</i> |  |  |
| Part no. | mm | mm | g | pc/box |
| 60218125C | 18 | 125 | 90 | 10 |
| 60221150C | 21 | 150 | 155 | 10 |
| 60226200C | 26 | 200 | 320 | 10 |
| 60229250C | 29 | 250 | 470 | 10 |
| 60234300C | 34 | 300 | 750 | 5 |





Quakeproof and safe chisel

| | | | | |
|----------------|------|----------|---|---|
| 602...Q | | <i>l</i> |  |  |
| Part no. | size | mm | g | pc/box |
| 60210150Q | 10 | 150 | 100 | 10 |
| 60212150Q | 12 | 150 | 102 | 10 |
| 60215180Q | 15 | 180 | 168 | 10 |
| 60219200Q | 19 | 200 | 320 | 5 |
| 60222200Q | 22 | 200 | 327 | 5 |
| 60225220Q | 25 | 220 | 440 | 5 |

NEW





Ribbed (Cold) chisel with sheath handle

| | | | | |
|----------------|------|----------|---|---|
| 602...Q | Size | <i>l</i> |  |  |
| Part no. | mm | mm | g | pc/box |
| 60229250Q | 29 | 250 | 540 | 10 |
| 60234300Q | 34 | 300 | 820 | 5 |





Cape chisel

| | | | | |
|---------------|------|----------|---|---|
| 603150 | | <i>l</i> |  |  |
| Part no. | size | mm | g | pc/box |
| 603150 | | 150 | 83 | 10 |



Quakeproof and safe cape chisel

| | | | | |
|----------------|------|----------|---|---|
| 603...Q | | <i>l</i> |  |  |
| Part no. | size | mm | g | pc/box |
| 603150Q | | 150 | 100 | 10 |



Pin punch

| 604 | | | | |
|------------|------|---------|-----|--------|
| Part no. | size | l mm | g | pc/box |
| 6042140 | 2 | 140 | 42 | 10 |
| 6043150 | 3 | 150 | 45 | 10 |
| 6044190 | 4 | 190 | 86 | 10 |
| 6045200 | 5 | 200 | 91 | 10 |
| 6046210 | 6 | 210 | 133 | 10 |
| 6048215 | 8 | 215 | 150 | 10 |
| 60410230 | 10 | 230 | 218 | 10 |
| 60412280 | 12 | 280 | 349 | 10 |
| 60414290 | 14 | 290 | 464 | 10 |
| 60416310 | 16 | 310 | 544 | 10 |



Taper punch

| 606 | | | | |
|------------|------|---------|-----|--------|
| Part no. | size | l mm | g | pc/box |
| 6062185 | 2 | 185 | 95 | 10 |
| 6063185 | 3 | 185 | 96 | 10 |
| 6064185 | 4 | 185 | 98 | 10 |
| 6065185 | 5 | 185 | 101 | 10 |
| 6066185 | 6 | 185 | 103 | 10 |
| 6068185 | 8 | 185 | 149 | 10 |



Quakeproof and safe pin punch

| 604...Q | | | | |
|----------------|------|---------|-----|--------|
| Part no. | size | l mm | g | pc/box |
| 6042140Q | 2 | 140 | 58 | 10 |
| 6043150Q | 3 | 150 | 59 | 10 |
| 6044190Q | 4 | 190 | 105 | 10 |
| 6045200Q | 5 | 200 | 106 | 10 |
| 6046210Q | 6 | 210 | 147 | 10 |
| 6048215Q | 8 | 215 | 166 | 10 |
| 60410230Q | 10 | 230 | 235 | 10 |
| 60412280Q | 12 | 280 | 381 | 5 |
| 60414290Q | 14 | 290 | 495 | 5 |
| 60416310Q | 16 | 310 | 575 | 5 |



Quakeproof and safe taper punch

| 606...Q | | | | |
|----------------|------|---------|-----|--------|
| Part no. | size | l mm | g | pc/box |
| 6062185Q | 2 | 185 | 114 | 10 |
| 6063185Q | 3 | 185 | 115 | 10 |
| 6064185Q | 4 | 185 | 116 | 10 |
| 6065185Q | 5 | 185 | 119 | 10 |
| 6066185Q | 6 | 185 | 120 | 10 |
| 6068185Q | 8 | 185 | 166 | 10 |



Spring pin punch

| 605 | | | | |
|------------|------|---------|----|--------|
| Part no. | size | l mm | g | pc/box |
| 60519090 | 1.9 | 90 | 18 | 10 |
| 60529095 | 2.9 | 95 | 18 | 10 |
| 60539115 | 3.9 | 115 | 33 | 10 |
| 60549115 | 4.9 | 115 | 35 | 10 |
| 60559140 | 5.9 | 140 | 56 | 10 |
| 60579150 | 7.9 | 150 | 74 | 10 |



Center punch

| 607 | | | | |
|------------|------|---------|-----|--------|
| Part no. | size | l mm | g | pc/box |
| 60725185 | 2.5 | 185 | 95 | 10 |
| 6074185 | 4 | 185 | 97 | 10 |
| 6076185 | 6 | 185 | 103 | 10 |
| 6078185 | 8 | 185 | 147 | 10 |
| 60710185 | 10 | 185 | 203 | 10 |



Quakeproof and safe center punch

| 607...Q | | | | |
|----------------|------|---------|-----|--------|
| Part no. | size | l mm | g | pc/box |
| 60725185Q | 2.5 | 185 | 114 | 10 |
| 6074185Q | 4 | 185 | 116 | 10 |
| 6076185Q | 6 | 185 | 120 | 10 |
| 6078185Q | 8 | 185 | 166 | 10 |
| 60710185Q | 10 | 185 | 219 | 10 |

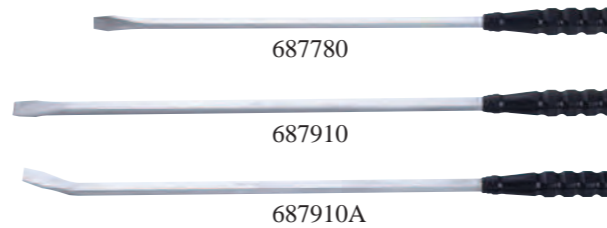

Jumbo pry bar

| 687 | | | |
|------------|-------------|------|-------------------|
| Part no. | Length | g | packing |
| 687780 | 780mm-30.7" | 1085 | 20/21.7/22.7/0.9' |
| 687910 | 910mm-36" | 1830 | 12/22.0/23.0/1' |
| 687910A | 910mm-36" | 1830 | 12/22.0/23.0/1' |



Engineer hammer

| 616 | | |
|-------------------|--------------------|------|
| Part no. | packing | g |
| 616200 NEW | 84/20.8/22.2/1.11' | 240 |
| 616300 | 48/20.7/22.7/1.11' | 431 |
| 616500 | 36/22.0/23.5/1.19' | 611 |
| 6161000 | 16/20.0/21.3/0.91' | 1250 |
| 6161500 | 12/21.0/22.1/0.84' | 1750 |

NEW



Recoilless hammer (head-replaceable)

| 616A | | |
|-------------|---------|------|
| Part no. | l mm | g |
| 616A025 | 25 | 389 |
| 616A030 | 30 | 435 |
| 616A035 | 35 | 505 |
| 616A040 | 40 | 606 |
| 616A045 | 45 | 865 |
| 616A050 | 50 | 952 |
| 616A055 | 55 | 1038 |
| 616A060 | 60 | 1125 |

*Steel handle with positive plastic grip.

*PU-material strike faces.

*Both strike faces can be repeatedly changed if broken.

NEW



Soft face hammer

| 616A400 | | |
|----------------|--------------------|-----|
| Part no. | packing | g |
| 616260 | 72/25.0/27.0/1.71' | 262 |
| 616400 | 48/26.0/28.0/1.62' | 280 |
| 616580 | 36/25.0/27.0/1.61' | 300 |
| 616810 | 24/23.0/25.0/1.35' | 320 |

*Hammer head: 1 yellow PU + 1 white Nylon

*Handle: natural color hickory



Rubber hammer

| 616 | | | |
|------------|--------------------|---------|-----|
| Part no. | packing | l mm | g |
| 616260 | 72/25.0/27.0/1.71' | 262 | 350 |
| 616400 | 48/26.0/28.0/1.62' | 280 | 520 |
| 616580 | 36/25.0/27.0/1.61' | 300 | 690 |
| 616810 | 24/23.0/25.0/1.35' | 320 | 940 |

NEW



Soft face hammer

| | | |
|----------------|-------------------|------|
| 616A700 | | |
| Part no. | 30/21.0/22.0/1.3' | 700g |

*Hammer head: black TPR & transparent yellow acetate head
*Handle: 1.4mm harden tubular steel handle, PVC ring & A type PVC grip

NEW



Ball pein hammer

| | | | |
|-------------|-------------------|-----|------|
| 616B | | | |
| Part no. | Packing | mm | g |
| 616B08 | 50/17.8/18.8/1.1' | 295 | 355 |
| 616B12 | 50/23.8/24.8/1.1' | 295 | 475 |
| 616B16 | 40/27.0/28.0/2.5' | 350 | 635 |
| 616B24 | 20/22.0/23.0/2.2' | 400 | 1000 |
| 616B32 | 20/25.0/26.0/2.2' | 400 | 1150 |
| 616B48 | 10/17.6/18.6/1.3' | 403 | 1755 |

NEW



Riveting hammer

| | | | |
|-------------|------|--------------------|------|
| 616F | | | |
| Part no. | Size | Packing | g |
| 616F032 | 32mm | 36/23.5/24.9/1.06' | 600 |
| 616F035 | 35mm | 24/19.4/20.5/0.85' | 760 |
| 616F040 | 40mm | 24/25.5/26.8/1.04' | 1040 |

*Head material: 1055 medium carbon steel
*Head polished: matt baked painted finished, striking face and end polished.
*Handle: Natural color hickory handle with laser "GENUINE HICKORY"



Utility knife

| | | |
|---------------|--------------------|------------|
| 5055P4 | | |
| Part no. | 100/16.8/17.8/1.6' | 165mm 168g |

* Blade available



Super heavy duty hacksaw

| | | |
|--------------|-------------------|------|
| 66301 | | |
| Part no. | 24/22.0/23.0/1.9' | 916g |

* Grip handle design
* Quick-change blade design
* Blade available



Mini hacksaw

| | | |
|--------------|-----------------|------|
| 66302 | | |
| Part no. | 72/15.7/16.7/1' | 218g |

* Ergonomic grip handle design.
* For plastic, wood or metal.
* Blade length 150mm, overlength 270mm.
* Blade available



Hacksaw

| | | |
|--------------|-------|----------------------|
| 66303 | | |
| Part no. | 135mm | 72/15.7/16.7/1' 100g |

* Blade available



Technician's scissors

| | | |
|-------------|-----------------|-----------|
| 6982 | | |
| Part no. | 72/7.0/9.0/1.4' | 145mm 80g |

* Designed for stripping and cutting the cable and wire up to 2mm diameter.
* Serrated edges can prevent objects from slipping away.
* Impact grips designed to fit human body engineering for the comfort of holding
* The inner ring of grips are made of TPR soft material. Fingers won't hurt after a long time holding.
* With an adjustable joint screw.

NEW



Technician's scissors

| | | |
|-------------|-----------------|--------|
| 6983 | | |
| Part no. | Packing | mm g |
| 6983 | 72/4.3/5.3/1.1' | 145 60 |

*ABS grip
*Thickness 2.5mm



Straight shears

| | | |
|---------------|----------------|-------------|
| 5055P1 | | |
| Part no. | Cutting Length | mm g |
| 5055P1 | 51mm | 254-10" 480 |
| 5055P112 | 70mm | 305-12" 650 |



Straight Cut



Left Cut



Right Cut

Aviation tin snips

| | | | | |
|------------|--------------|-----|----------|-----|
| 698 | | | | |
| Part no. | Direction | mm | CuttingL | g |
| 6981250 | Straight cut | 250 | 38mm | 400 |
| 698L248 | Left cut | 248 | 35mm | 400 |
| 698R248 | Right cut | 248 | 35mm | 400 |

NEW



Offset snips

| | | |
|-------------|--------------------|------|
| 6985 | | |
| Part no. | 48/24.0/25.0/1.97' | 540g |

· Material: CRM-63 steel blades
· Hardness: 58-61 HRC
· Blade: Black phosphate finish resists rust.
Functions and features:
1. Special laborsaving design for easier cutting.
2. Serrated edges allowing stable hold and preventing slipping when cutting.
3. Center fastener for high tensile strength and longer life.
4. Solid and comfortable handle with non-slip design.
5. Hot drop forged blades: Alloy steel forged blades for greater strength and longer durability.

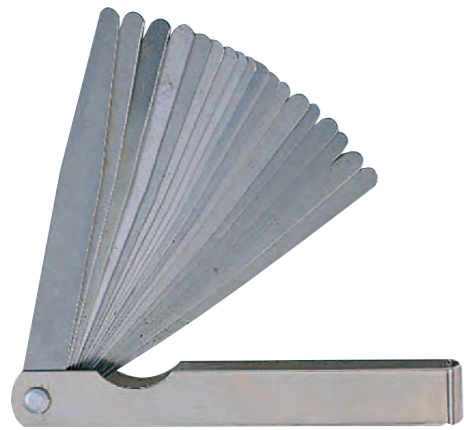

20pcs Feeler gauge

| | | | |
|------------|--------------------|-------|------|
| 618 | | | |
| Part no. | 100/10.4/11.4/1.1' | 105mm | 104g |

included 20 blades 0.05mm to 1.00mm

26pcs Feeler gauge New

| | | | |
|--------------|--------------------|------|------|
| 61802 | | | |
| Part no. | 100/12.0/13.0/1.1' | 95mm | 120g |

included 26 blades
 0.04mm(.0015");0.05mm(.002");0.06mm(.0025")
 0.08mm(.003");0.10mm(.004");0.13mm(.005")
 0.15mm(.006");0.18mm(.007");0.20mm(.008")
 0.23mm(.009");0.25mm(.010");0.28mm(.011")
 0.30mm(.012");0.33mm(.013");0.35mm(.014")
 0.38mm(.015");0.40mm(.016");0.43mm(.017")
 0.45mm(.018");0.48mm(.019");0.50mm(.020")
 0.53mm(.021");0.55mm(.022");0.58mm(.023")
 0.60mm(.024");0.63mm(.025")

NEW



9pc Offset feeler gauge

| | | | |
|--------------|--------------------|-------|------|
| 61803 | | | |
| Part no. | 100/10.4/11.4/1.4' | 100mm | 104g |

*SIZE: 0.009"-0.015"-0.016"-0.017"-0.018"
 0.019"-0.020"-0.021"-0.026"

*Decimal sizes & metric equivalents on each blade
 *Blades L xW: 4"x1/2"(100x13mm)



Measuring tape

| | | | |
|---------------------|------|--------------------|-----|
| 5096P8 | | | |
| Part no. | Size | Packing | g |
| 5096P803 | 3m | 100/9.0/10.0/2.4' | 90 |
| 5096P8 | 5m | 100/20.0/21.0/2.4' | 180 |
| 5096P808 | 8m | 60/21.6/22.6/1.8' | 270 |
| 5096P810 NEW | 10m | 60/27.5/28.5/1.8' | 420 |

NEW



Measuring tape

| | | | |
|---------------|----------|-------------------|-----|
| 5096P8 | | | |
| Part no. | Size (m) | Packing | g |
| 5096P815 | 15 | 60/15.2/16.2/1.6' | 250 |
| 5096P830 | 30 | 30/14.8/15.8/2.2' | 500 |
| 5096P850 | 50 | 30/20.1/21.1/2.2' | 670 |

NEW



Aluminum box level

| | | | |
|------------|--------|-------------------|-----|
| 891 | | | |
| Part no. | Length | Packing | g |
| 891300 | 12 | 60/13.0/14.0/1.2' | 215 |
| 891400 | 16 | 48/13.0/14.0/1.3' | 270 |
| 891600 | 24 | 36/14.0/15.0/1.4' | 390 |

* 1.5mm thickness aluminum alloy body.
 * Cylindrical vials
 * Accuracy: 1mm/M



Grey cast iron bench vise(without base)

| | | | |
|--------------|----------|--------------|-------------------|
| 65401 | | | |
| Part no. | Jaw open | Throat depth | Packing |
| 6540104 | 4" | 2-5/8" | 1/12.2/13.2/0.43' |
| 6540105 | 5" | 3-1/4" | 1/16.0/17.0/0.6' |
| 6540106 | 6" | 3-3/4" | 1/21.5/22.5/0.82' |
| 6540108 | 8" | 4" | 1/29.2/30.2/0.97' |



All steel swivel base vise

| | | | |
|--------------------|----------|--------------|------------------|
| 65402 | | | |
| Part no. | Jaw open | Throat depth | Packing |
| 6540204 | 4" | 2-1/4" | 1/7.5/8.5/0.4' |
| 6540205 | 5" | 2-5/8" | 1/11.0/12.0/0.6' |
| 6540206 | 6" | 3" | 1/14.5/15.5/0.8' |
| 6540208 | 8" | 3-1/2" | 1/20.5/21.5/1.2' |
| 6540210 NEW | 10" | 4" | 1/25.6/26.9/1.5' |

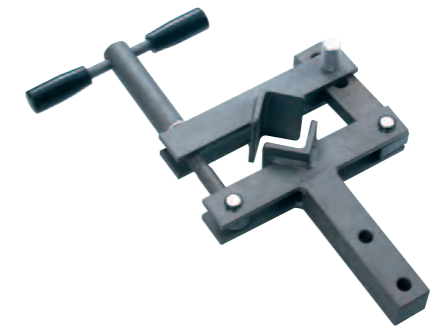

Special vise for shock absorption

| | | |
|--------------|------------------|-------|
| 65403 | | |
| Part no. | 5/16.6/17.6/1.1' | 3350g |



Drilling press vise

| | | | |
|----------------|----------|--------------|-------------------|
| 65404.. | | | |
| Part no. | Jaw Open | Throat Depth | Packing |
| 6540403 | 2-3/4" | 3/4" | 4/8.2/9.2/0.44' |
| 6540404 | 4" | 1" | 4/11.0/12.0/0.63' |
| 6540405 | 5" | 1" | 4/16.0/17.0/0.77' |
| 6540406 | 5-1/2" | 1" | 4/22.5/24.5/1.08' |

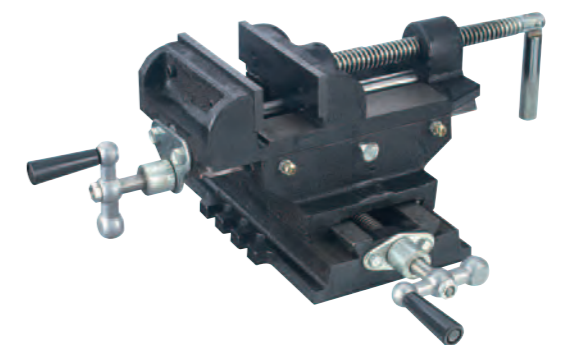

Cross vise

| | | |
|----------------|----------|-------------------|
| 65405.. | | |
| Part no. | Jaw Open | Packing |
| 6540503 | 3" | 1/6.2/7.0/0.31' |
| 6540504 | 4" | 1/10.0/11.0/0.44' |
| 6540505 | 5" | 1/13.5/15.0/0.5' |
| 6540506 | 6" | 1/16.5/18.0/0.65' |

NEW

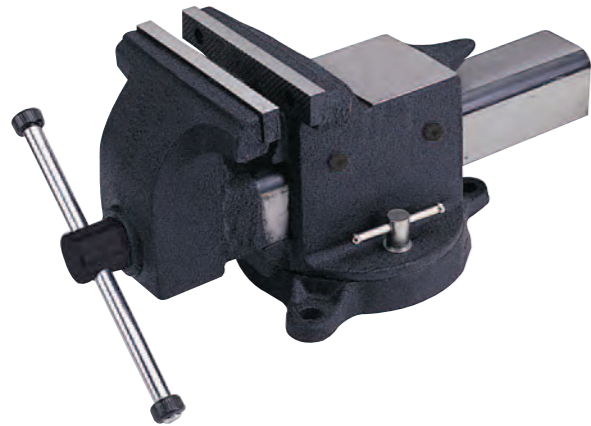

Forged steel bench vise

| Part No. | Jaw opening | Packing | kg |
|--------------|-------------|---------------------|------|
| 65406 | | | |
| 6540604 | 4" | 1/ 8.4 / 8.5 / 0.3' | 8.4 |
| 6540605 | 5" | 1/12.5/13.5/0.4' | 12.5 |
| 6540606 | 6" | 1/20.5/21.5/0.5' | 20.5 |



Limber magnetic LED light

| Part no. | | | |
|--------------|-------------------|-----|--|
| 68602 | | | |
| | 120/9.2/10.7/3.5' | 77g | |



LED white light, clip-type (360°rotation)

| Part no. | | | |
|--------------|------------------|-----|--|
| 68601 | | | |
| | 120/6.0/7.5/1.9' | 50g | |



Magnetic LED head light

| Part no. | | | |
|--------------|--------------|------|--|
| 68603 | | | |
| | 100/18/19/3' | 180g | |



Round magnetic tray

| Part no. | | | |
|--------------|-------------------|------|--|
| 88001 | | | |
| | 30/12.0/13.0/1.5' | 400g | |

- * Ø150mmL
- * Functions:
 1. One heavy duty 1000 ~ 1200 gauss permanent magnets.
 2. Vulcanized rubber coating prevent scuffing and scratching to valuable surface.
 3. Stainless steel tray resists corrosion.
 4. Can be used horizontally, vertically, and upside down.
 5. Convenient for collecting small parts and tools.



Rectangular magnetic tray (3 magnets)

| Part no. | | | |
|--------------|-------------------|-------|--|
| 88003 | | | |
| | 12/15.0/16.0/1.4' | 1250g | |

- * L360mm x W160mm
- * Functions:
 1. 14-1/8" x 6-1/4" x 1-1/2" rectangle Stainless steel tray.
 2. Three Heavy Duty magnets with durable rubber coating to help prevent scuffing and scratching.
 3. Great for small parts, fasteners and tools.
 4. Can be used horizontally, vertically or upside down.



Rectangular magnetic tray (2 magnets)

| Part no. | | | |
|--------------|--------------------|------|--|
| 88002 | | | |
| | 20/14.7/15.7/2.28' | 735g | |

- * L242mm x W132mm
- * Functions:
 1. 5-1/2" x 9-1/2" x 1-1/2" rectangle Stainless steel tray.
 2. Two Heavy Duty magnets with durable rubber coating to help prevent scuffing and scratching.
 3. Great for small parts, fasteners and tools.
 4. Can be used horizontally, vertically or upside down.



Square magnetic tray

| Part no. | | | |
|--------------|-----------------|-------|--|
| 88004 | | | |
| | 6/8.5/9.5/1.42' | 1420g | |

- * L293mm x W270mm
- * Functions:
 1. Square Stainless steel tray.
 2. Heavy Duty magnets with durable rubber coating to help prevent scuffing and scratching
 3. Great for small parts, fasteners and tools
 4. Can be used horizontally, vertically or upside down



EZ-release magnetic pick-up

| | | |
|--------------|-------------|------|
| 88011 | | |
| Part no. | 12/7/9/2.1' | 584g |

- *680mmL(26-3/4")
- *Capacity: 8 LDBS (3.63 kgw)
- *Functions:

1. EZ- Release magnetic pick up tool has a magnetic device that is able to attract any metallic items or spare parts laying on the floor without having to go through the trouble and pick them up one by one.
2. Pull the trigger and drop the items easily.
3. Easy clean up the work zone in factory, house or shop.
4. Easy to use, safe and practical time saving device.
5. Permanent magnet.



Midi EZ-release magnetic pick-up

| | | |
|--------------|-------------------|------|
| 88012 | | |
| Part no. | 24/15.1/16.6/2.5' | 630g |

- * 110x110x190mm
- * Capacity: 10 LDBS (4.54kgw)
- * Functions:

1. Easy pick-up and release of metallic materials.
2. Just squeeze the handle to quickly release material.



3-in-1 Magnetic flexible pickup tool with light & mirror

| | | |
|-------------|-----------------|------|
| 617L | | |
| Part no. | 72/15.1/16.1/2' | 210g |

- * Positive action turn on/off switch
- * Magnetic pick-up 3.5lbs. (1.6kgw)
- * Flexible shank of dia. 8.5mm and length 455mm(17-7/8")
- * Oval glass mirror 25 x 50mm (1-1/8"x2")
- * Replaceable bulb (2.2V, 0.25A)
- * Inspection light is operated with 2pc x AA batteries (not included)



Heavy-duty flexible magnet pick-up tool

| | | |
|--------------|--------------------|------|
| 61701 | | |
| Part no. | 100/19.0/20.0/1.9' | 190g |

- *Flexible shank diameter 8.5mm; 440mmL
- *With plastic PVC grip
- *Magnetic Capacity: 3.5Lbs(1.6Kgw)
- *Overall length: 535mm(21")



Flexible magnet pick-up tool

| | | |
|--------------|-------------------|------|
| 61702 | | |
| Part no. | 72/11.0/12.0/1.8' | 150g |

- *Flexible shank diameter 5.0mm; 400mmL
- *With plastic PP grip
- *Magnetic Capacity: 1.5Lbs(0.7Kgw)
- *Overall length: 510mm(20")



Hinged flexible inspection mirror

| | | |
|--------------|-------------------|------|
| 61703 | | |
| Part no. | 36/11.0/12.0/2.3' | 300g |



Multi-function magnetic pick-up

| | | |
|------------|------------------|-----------|
| 617 | | |
| Part no. | 100/8.2/9.2/1.1' | 235mm 82g |

- *Magnetic pick-up tool in telescopic extended, maximum 63cm extension.
- *Take off the cap of bottom, the needle point head can be used for marking when draw a line or clean the narrow slot and small hole.
- *Attach a fully adjustable mirror for inspection.
- *all in one handy tool with pocket clip.



3-Claw pick-up tool

| | | |
|--------------|--------------------|------|
| 88901 | | |
| Part no. | 150/15.1/16.1/1.2' | 100g |

- * Length:560mmL



External thread restorer files

| | | |
|--------------|-------------------|------|
| 66901 | | |
| Part no. | 72/15.0/16.0/1.2' | 208g |

- Metric file / pitch size :
- 0.75; 1.00; 1.25; 1.50; 1.75; 2.00; 2.50; 3.00

External thread restorer files

| | | |
|--------------|-------------------|------|
| 66902 | | |
| Part no. | 72/15.0/16.0/1.2' | 208g |

- SAE file / pitch size :
- 11; 12; 13; 14; 16; 18; 20; 24

External thread restorer files

| | | |
|--------------|-------------------|------|
| 66903 | | |
| Part no. | 72/15.0/16.0/1.2' | 208g |

- SAE file / pitch size :
- 9; 10; 12; 16; 20; 27; 28; 32

- *Rostore tool for renewing damaged thread on any diameter bolt, stud, axle of shaft file, both right and left threads.



1/2" DR. Stud extractor

| 818 | | <i>l</i> | | |
|----------|-------|----------|-----|--------|
| Part no. | size | mm | g | pc/box |
| 81805 | 5 | 60 | 127 | 10 |
| 81806 | 6 | 60 | 132 | 10 |
| 81807 | 7 | 60 | 130 | 10 |
| 81808 | 8 | 60 | 130 | 10 |
| 81810 | 10 | 68 | 186 | 10 |
| 81812 | 12 | 68 | 184 | 10 |
| 81814 | 14 | 68 | 253 | 10 |
| 8183.16 | 3/16" | 60 | 126 | 10 |
| 8181.4 | 1/4" | 60 | 126 | 10 |
| 8185.16 | 5/16" | 60 | 124 | 10 |
| 8183.8 | 3/8" | 68 | 176 | 10 |
| 8187.16 | 7/16" | 68 | 172 | 10 |
| 8181.2 | 1/2" | 68 | 196 | 10 |

NEW



Nut buster

| 9U10A | size | | |
|----------|------|-------------------|------|
| Part no. | Inch | Packing | g |
| 9U10A07 | 7 | 72/16.6/17.6/1.4' | 230 |
| 9U10A10 | 10 | 36/19.0/20.0/1' | 525 |
| 9U10A14 | 14 | 16/18.0/19.0/1.1' | 1125 |

* Polish finish

NEW



Quick-grip wrench

| 9U10B | size | | |
|----------|--------|---------------------|-----|
| Part no. | Inch | Packing | g |
| 9U10B08 | 200-8" | 8-19 (5/16"-3/4") | 220 |
| 9U10B12 | 300-12 | 14-32(9/16"-1-1/4") | 590 |

- Chrome molybdenum steel
- Drop forged (CR-MO) steel construction.
- Heat treated, sandblasted, and chrome plated.
- Fast ratcheting function removes or installs square or hex nuts and bolts, even stripped ones.

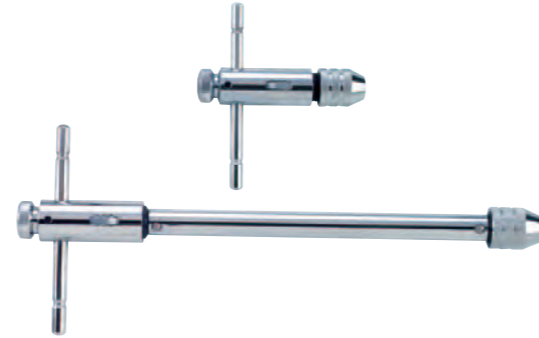

T tap wrench (Ratchet type)

| 881 | | <i>l</i> | |
|----------|--------------------|----------|-----|
| Part no. | Tap range | mm | g |
| 8812090 | 1/8"-1/4" (3-6mm) | 90 | 190 |
| 8812250 | 1/8"-1/4" (3-6mm) | 250 | 280 |
| 8814110 | 1/4"-1/2" (6-12mm) | 110 | 320 |
| 8814300 | 1/4"-1/2" (6-12mm) | 300 | 460 |



Multi-purpose framework

| 63201 | | |
|----------|--------------------|------|
| Part no. | 100/14.0/15.0/2.9' | 140g |

* make our tools orderly.



Long nose straight long pliers

| 5047P1 | | <i>l</i> | | |
|----------|--------------------|-----------|-----|--------|
| Part no. | packing | mm | g | pc/box |
| 5047P1 | 50/16.5/17.5/0.64' | 280-11" | 330 | 5 |
| 5047P1L | 50/17.5/18.5/0.83' | 400-15.7" | 480 | 5 |



Long nose 45° long pliers

| 5047P2 | | <i>l</i> | | |
|----------|--------------------|-----------|-----|--------|
| Part no. | packing | mm | g | pc/box |
| 5047P2 | 50/16.5/17.5/0.64' | 280-11" | 330 | 5 |
| 5047P2L | 50/17.5/18.5/ 1.1' | 400-15.7" | 480 | 5 |



Long nose 90° long pliers

| 5047P3 | | <i>l</i> | | |
|----------|--------------------|-----------|-----|--------|
| Part no. | packing | mm | g | pc/box |
| 5047P3 | 50/16.5/17.5/0.64' | 280-11" | 330 | 5 |
| 5047P3L | 50/17.5/18.5/1.1' | 400-15.7" | 480 | 5 |



Multi-purpose 4 points gripping pliers

| 5047P4 | | <i>l</i> | | |
|----------|--------------------|----------|-----|--------|
| Part no. | packing | mm | g | pc/box |
| 5047P4 | 50/16.5/17.5/0.64' | 280-11" | 330 | 5 |



Bent long nose pliers

| 610B..B | | <i>l</i> | |
|----------|-------------------|----------|-----|
| Part no. | packing | mm | g |
| 610B150B | 50/9.3/10.3/1.1' | 150-6" | 186 |
| 610B200B | 50/11.0/12.0/1.9' | 200-8" | 220 |



Mini nose pliers

| 610110 | | <i>l</i> | |
|----------|------------------|----------|----|
| Part no. | packing | mm | g |
| 610110 | 120/8.4/9.4/2.4' | 140 | 70 |



Long nose pliers

| 610 | | <i>l</i> | |
|----------|-------------------|----------|-----|
| Part no. | packing | mm | g |
| 610150 | 60/9.7/10.7/1' | 150-6" | 162 |
| 610200 | 60/15.5/16.5/1.4' | 200-8" | 258 |



Long nose pliers

| 610B | | <i>l</i> | |
|----------|------------------|----------|-----|
| Part no. | packing | mm | g |
| 610B145 | 50/8.0/9.0/1.2' | 145-5.7" | 160 |
| 610B160 | 50/9.3/10.3/1.2' | 160-6.3" | 186 |
| 610B200 | 50/11.0/12.0/2' | 200-8" | 220 |



Combination pliers

| 611 | | <i>l</i> | |
|----------|-------------------|----------|-----|
| Part no. | packing | mm | g |
| 611150 | 60/12.6/13.6/0.9' | 150-6" | 210 |
| 611175 | 60/16.8/17.8/1.6' | 175-7" | 280 |
| 611215 | 50/20.6/21.6/1.2' | 215-8.5" | 412 |



Combination pliers

| 611B | | <i>l</i> | |
|----------|-------------------|----------|-----|
| Part no. | packing | mm | g |
| 611B160 | 60/15.7/16.7/1.5' | 160-6.3" | 261 |
| 611B175 | 60/16.8/17.8/2' | 175-7" | 280 |
| 611B200 | 60/22.8/23.8/1.8' | 200-8" | 380 |

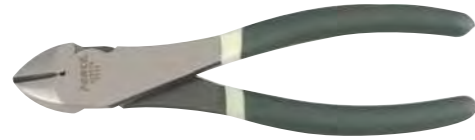

Diagonal pliers

| Part no. | packing | mm | g |
|---------------|-------------------|----------|-----|
| 612175 | | <i>l</i> | |
| 612175 | 60/14.2/15.2/1.3' | 175-7" | 245 |



Diagonal pliers

| Part no. | packing | mm | g |
|-------------|-------------------|----------|-----|
| 612B | | <i>l</i> | |
| 612B160 | 60/14.3/15.3/1.6' | 160-6.3" | 238 |
| 612B175 | 60/15.6/16.6/2' | 175-7" | 260 |



Mini diagonal pliers

| Part no. | packing | mm | g |
|---------------|----------------|----------|----|
| 612140 | | <i>l</i> | |
| 612140 | 120/7.7/8.7/2' | 110 | 65 |



Waterpump pliers

| Part no. | packing | mm | g |
|------------|-------------------|----------|------|
| 613 | | <i>l</i> | |
| 613200 | 60/13.5/14.5/1.5' | 200-8" | 225 |
| 613250 | 50/23.7/24.7/1.6' | 250-10" | 470 |
| 613300 | 20/18.8/19.8/1.1' | 300-12" | 680 |
| 613410 | 12/15.6/16.6/0.5' | 410-16" | 1300 |



Heavy duty water pump pliers

| Part no. | packing | mm | g |
|----------------|----------------|----------|------|
| 613A500 | | <i>l</i> | |
| 613A500 | 10/17/18/1.54' | 500 | 1700 |



Waterpump pliers

| Part no. | packing | mm | g |
|----------------|-------------------|----------|-----|
| 613B250 | | <i>l</i> | |
| 613B250 | 50/20.5/21.5/1.7' | 250-10" | 410 |



Slip joint pliers

| Part no. | packing | mm | g |
|-------------|-------------------|----------|-----|
| 673B | | <i>l</i> | |
| 673B160 | 60/14.3/15.3/1.2' | 160-6.3" | 238 |
| 673B215 | 60/16.5/17.5/2' | 215-8.5" | 275 |
| 673B250 | 60/20.4/21.4/2' | 250-10" | 340 |



Hoof nipper

| Part no. | packing | mm | g |
|----------------|--------------------|----------|-----|
| 6961300 | | <i>l</i> | |
| 6961300 | 20/17.4/18.4/0.56' | 300-12" | 900 |



Trim pliers

| Part no. | packing | mm | g |
|----------------|-------------------|----------|------|
| 6962350 | | <i>l</i> | |
| 6962350 | 20/21.4/22.4/0.8' | 350-14" | 1070 |



Crocodile pliers

| Part no. | packing | mm | g |
|----------------|-------------------|----------|-----|
| 6963330 | | <i>l</i> | |
| 6963330 | 20/14.2/15.2/0.8' | 330-13" | 710 |



Fence pliers

| Part no. | packing | mm | g |
|-------------|-------------------|----------|-----|
| 6964 | | <i>l</i> | |
| 6964260 | 40/20.0/21.0/1' | 260-10" | 500 |
| 6964310 | 20/14.8/15.8/0.8' | 310-12" | 740 |

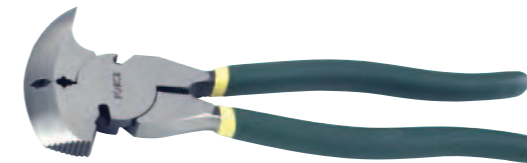

Fencing tool

| Part no. | packing | mm | g |
|----------------|--------------------|----------|-----|
| 6965265 | | <i>l</i> | |
| 6965265 | 20/14.1/15.1/0.64' | 265-10" | 703 |



Fishing pliers

| Part no. | packing | mm | g |
|----------------|-------------------|----------|-----|
| 6951125 | | <i>l</i> | |
| 6951125 | 60/25.2/26.2/3.2' | 124 | 420 |



Tower pincers

| Part no. | packing | mm | g |
|-------------|-------------------|----------|-----|
| 6971 | | <i>l</i> | |
| 6971230 | 40/16.8/17.8/0.6' | 230 | 420 |
| 6971250 | 40/19.2/20.2/1.2' | 250 | 480 |
| 6971280 | 30/15.9/16.9/0.9' | 280 | 530 |



Carpenter's pincers

| Part no. | packing | mm | g |
|----------------|-------------------|----------|-----|
| 6972180 | | <i>l</i> | |
| 6972180 | 60/18.9/19.9/1.2' | 180 | 315 |

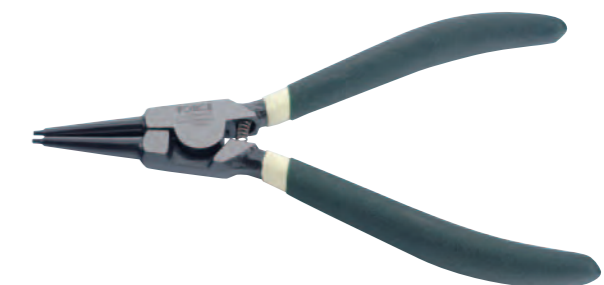

Snap ring pliers (external straight tip 1.8mm)

| Part no. | Capacity | packing | mm | g |
|------------------|----------|--------------------|----------|-----|
| 609...ASO | | | <i>l</i> | |
| 60905ASO | 8-25mm | 30/2.4/3.4/0.38' | 140-5.5" | 80 |
| 609ASO | 19-60mm | 30/4.5/5.5/0.69" | 180-7" | 150 |
| 60909ASO | 40-100mm | 30/9.0/11.0/1.2' | 230-9" | 300 |
| 60912ASO | 85-165mm | 25/12.3/13.3/0.88' | 310-12" | 490 |

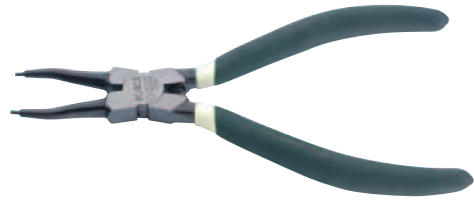

Snap ring pliers (internal straight tip 1.8mm)

| Part no. | Capacity | packing | mm | g |
|---------------------|----------|-------------------|----------|-----|
| 60905ASC | 8-25mm | 30/2.4/3.4/0.38' | 140-5.5" | 80 |
| 609ASC | 19-60mm | 30/4.5/5.5/0.69' | 180-7" | 150 |
| 60909ASC | 40-100mm | 30/9.0/11.0/1.2' | 230-9" | 300 |
| 60912ASC NEW | 85-165mm | 25/11.7/12.7/1.2' | 310-12" | 470 |

*60912ASC is without a spring



Snap ring pliers (external 90° bent tip 1.8mm)

| Part no. | Capacity | packing | mm | g |
|---------------------|----------|-------------------|----------|-----|
| 60905ABO | 8-25mm | 30/2.4/3.4/0.38' | 140-5.5" | 80 |
| 609ABO | 19-60mm | 30/4.5/5.5/0.69' | 180-7" | 150 |
| 60909ABO | 40-100mm | 30/9.0/11.0/1.2' | 230-9" | 300 |
| 60912ABO NEW | 85-165mm | 25/12.8/13.8/1.2' | 310-12" | 510 |



Snap ring pliers (internal 90° bent tip 1.8mm)

| Part no. | Capacity | packing | mm | g |
|---------------------|----------|-------------------|---------|-----|
| 60905ABC | 8-25mm | 30/2.4/3.4/0.38' | 40-5.5" | 80 |
| 609ABC | 19-60mm | 30/4.5/5.5/0.69' | 180-7" | 150 |
| 60909ABC | 40-100mm | 30/9.0/11.0/1.2' | 230-9" | 300 |
| 60912ABC NEW | 85-165mm | 25/11.6/12.6/1.2' | 310-12" | 465 |

*60912ABC is without a spring.

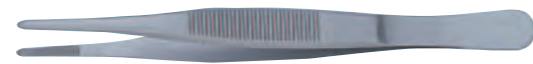

High-precision specialized tweezers

| Part no. | L(inch) | L(mm) | g | pc/box |
|--------------------|---------|-------|----|--------|
| 6941 | | | | |
| 6941125 | 4.9 | 125 | 10 | 10 |
| 6941140 NEW | 5.5 | 140 | 10 | 10 |
| 6941180 | 7.1 | 180 | 10 | 10 |

*Feature: Straight non-toothed Matt finish
Drop-forged Stainless special grade steel



High-precision specialized tweezers

| Part no. | L(inch) | L(mm) | g | pc/box |
|----------|---------|-------|----|--------|
| 6943125 | | | | |
| 6943125 | 4.9 | 125 | 10 | 10 |

*Feature: Angular non-toothed Matt finish
Drop-forged Stainless special grade steel



High-precision specialized tweezers

| Part no. | L(inch) | L(mm) | g | pc/box |
|----------|---------|-------|----|--------|
| 6944160 | | | | |
| 6944160 | 6.3 | 160 | 10 | 10 |

*Feature: Angular smooth-jaw Matt finish
Drop-forged Stainless special grade steel

NEW



High-precision specialized tweezers

| Part no. | L(inch) | L(mm) | g | pc/box |
|----------|---------|-------|----|--------|
| 6945140 | | | | |
| 6945140 | 5.5 | 140 | 10 | 10 |

*Feature: Z-shaped needle-tip Matt finish
Drop-forged Stainless special grade steel



Rivet pliers

| Part no. | packing | mm | g |
|----------|-------------------|-----|-----|
| 67801 | 20/15.7/16.7/2.1' | 180 | 785 |



Grade nut fastener

| Part no. | packing | mm | g |
|----------|-------------------|-----|-----|
| 67802 | 20/11.6/12.6/1.5' | 280 | 582 |



Tie down pliers

| Part no. | packing | mm | g |
|----------|---------------|-----|-----|
| 54111P1 | | | |
| 54111P1 | 60/13/14/3.4' | 170 | 216 |



4-in-1 Electrical pliers

| Part no. | packing | mm | g |
|----------|------------------|--------|-----|
| 6921160 | | | |
| 6921160 | 60/9.6/10.6/1.2' | 160-6" | 160 |



Diagonal cutting pliers

| Part no. | packing | mm | g |
|----------|-------------------|--------|-----|
| 6922160 | | | |
| 6922160 | 60/12.0/13.0/1.6' | 160-6" | 200 |



Cable cutter

| Part no. | packing | mm | g |
|----------|-------------------|-----|-----|
| 6923 | | | |
| 6923160 | 60/9.6/10.6/1.6' | 160 | 180 |
| 6923200 | 60/18.0/19.0/1.6' | 200 | 300 |



Cable cutter

| Part no. | packing | mm | g |
|----------|-------------------|-----|-----|
| 6924250 | | | |
| 6924250 | 40/21.2/22.2/0.9' | 250 | 530 |



Plastic cutting pliers

| Part no. | packing | mm | g |
|----------|-------------------|-----|-----|
| 6925 | | | |
| 6925160 | 60/8.4/9.4/1.3' | 160 | 140 |
| 6925180 | 60/10.8/11.8/1.5' | 180 | 180 |

NEW



Pipe gripping pliers

| Part no. | Packing | mm | g |
|----------|-----------------|-----|-----|
| 6957240 | 40/20.0/21.0/2' | 240 | 500 |

NEW



Wire twisting pliers

| Part no. | Packing | mm | g |
|----------|-------------------|-----|-----|
| 6958160 | 80/19.0/20.0/1.1' | 160 | 220 |
| 6958225 | 60/22.1/23.1/1.1' | 225 | 360 |

NEW



Wire rope cutter

| Part no. | Packing | mm | g |
|----------|-------------------|-----|-----|
| 6959180 | 60/17.0/18.0/1.1' | 180 | 280 |

NEW



End cutting nippers

| Part no. | Packing | mm | g |
|----------|-------------------|-----|-----|
| 6976200 | 50/17.5/18.5/1.4' | 200 | 310 |



Wire stripper pliers

| Part no. | packing | mm | g |
|----------|------------------|--------------------|-----|
| 6804B160 | 60/9.6/10.6/1.3' | Length: 160mm-6.3" | 160 |



Stripper pliers

| Part no. | packing | mm | g |
|----------|-------------------|-----|-----|
| 6804 | 50/10.3/11.3/1.2' | 178 | 206 |



Heavy duty stripper pliers

| Part no. | packing | mm | g |
|----------|-------------------|-----|-----|
| 6805 | 60/21.0/22.0/2.3' | 210 | 311 |

*Cut and strip 10-24 AWG copper or aluminum wire, solid or stranded
 *Crimp 10-22 AWG insulated terminals
 *Crimp 4-22 AWG non-insulated terminals
 *Crimp 7-8 mm ignition terminals



Terminal pliers red, blue, yellow

| Part no. | packing | mm | g |
|----------|-------------------|-----|-----|
| 6801 | 30/15.8/16.8/1.5' | 233 | 528 |



Terminal pliers 0.5; 0.75; 1.0; 1.5; 2.5; 4

| Part no. | packing | mm | g |
|----------|-------------------|-----|-----|
| 6802 | 30/16.5/17.5/1.5' | 233 | 549 |



Terminal pliers 0.5-1; 1.1-2.5; 4-6

| Part no. | packing | mm | g |
|----------|-------------------|-----|-----|
| 6803 | 30/16.1/17.1/1.5' | 233 | 535 |

NEW

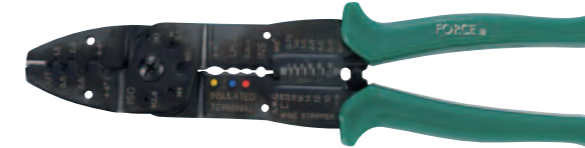

Multi-purpose crimping tool

| Part no. | Packing | mm | g |
|----------|-----------------|-----|-----|
| 6806 | 40/11.8/12.8/1' | 245 | 251 |



Insulated combination pliers

| Part no. | packing | mm | g |
|----------|-----------------|--------|-----|
| 6901225 | 30/15.8/16.8/1' | 225-9" | 528 |



Insulated bent nose pliers

| Part no. | packing | mm | g |
|----------|--------------------|--------|-----|
| 6902160 | 60/11.1/12.1/0.64' | 160-6" | 185 |
| 6902200 | 60/17.4/18.4/0.93' | 200-8" | 290 |



Insulated combination pliers

| Part no. | packing | mm | g |
|----------|--------------------|--------|-----|
| 6903160 | 60/15.0/16.0/0.93' | 160-6" | 250 |
| 6903180 | 60/18.0/19.0/0.93' | 180-7" | 300 |
| 6903200 | 60/22.5/23.5/1.3' | 200-8" | 375 |



Insulated long nose pliers

| Part no. | packing | mm | g |
|----------|--------------------|--------|-----|
| 6904160 | 60/11.1/12.1/0.64' | 160-6" | 185 |
| 6904200 | 60/17.4/18.4/0.9" | 200-8" | 290 |



Insulated diagonal cutting pliers

| 6905160 | | | |
|----------------|-------------------|--------|-----|
| Part no. | packing | mm | g |
| 6905160 | 60/14.4/15.4/0.9' | 160-6" | 240 |



Insulated diagonal pliers

| 6911 | | | |
|-------------|--------------------|--------|-----|
| Part no. | packing | mm | g |
| 6911180 | 60/15.3/16.3/0.93' | 180-7" | 255 |
| 6911200 | 60/17.4/18.4/0.93' | 200-8" | 290 |



Insulated water pump pliers (Curved jaw)

| 6907250 | | | |
|----------------|-------------------|---------|-----|
| Part no. | packing | mm | g |
| 6907250 | 30/16.8/17.8/1.5' | 250-10" | 280 |



Insulated wire stripper pliers

| 6912160 | | | |
|----------------|-------------------|--------|-----|
| Part no. | packing | mm | g |
| 6912160 | 60/11.4/12.4/1.6' | 160-6" | 190 |



Insulated long round nose pliers

| 6908160 | | | |
|----------------|--------------------|--------|-----|
| Part no. | packing | mm | g |
| 6908160 | 60/10.2/11.2/0.64" | 160-6" | 170 |



Insulated flat nose pliers

| 6913160 | | | |
|----------------|--------------------|--------|-----|
| Part no. | packing | mm | g |
| 6913160 | 60/12.0/13.0/0.64" | 160-6" | 200 |



Insulated cable cutter

| 6909250 | | | |
|----------------|-----------------|---------|-----|
| Part no. | packing | mm | g |
| 6909250 | 30/15.9/16.9/1' | 250-10" | 530 |



Insulated cable cutter

| 6914 | | | |
|-------------|-------------------|--------|-----|
| Part no. | packing | mm | g |
| 6914160 | 60/10.8/11.8/1.3' | 160-6" | 180 |
| 6914200 | 60/18.0/19.0/1.5' | 200-8" | 300 |



Induction circuit tester

| 2125P1 | | | |
|---------------|------------------|-----|----|
| Part no. | packing | mm | g |
| 2125P1 | 100/8.6/9.6/4.5' | 165 | 86 |



Electric voltage detector with buzzer

| 88406 | | | |
|--------------|------------------|-------|-----|
| Part no. | packing | mm | g |
| 88406 | 180/7.0/8.5/2.3' | 155mm | 39g |

Testing range: 100~600V AC.



Screwdriver probe voltage tester

| 88401 | | | |
|--------------|------------------|-------|-----|
| Part no. | packing | mm | g |
| 88401 | 200/6.5/7.5/4.6' | 145mm | 33g |

Testing range: 110~250V AC.



Adjustable non-contact wire tracer

| 88407 | | | |
|--------------|------------------|-------|-----|
| Part no. | packing | mm | g |
| 88407 | 100/5.1/6.1/1.3' | 160mm | 51g |

Testing range: 12~600V AC.



Screwdriver probe voltage tester

| 88402 | | | |
|--------------|-------------------|-------|-----|
| Part no. | packing | mm | g |
| 88402 | 200/9.5/10.5/4.6' | 190mm | 48g |

Testing range: 110~250V AC.



Universal voltage tester

| 88408 | | | |
|--------------|------------------|-------|------|
| Part no. | packing | mm | g |
| 88408 | 60/9.7/10.7/2.7' | 210mm | 162g |

Testing range: 6~400V AC.



Screwdriver probe voltage tester

| 88403 | | | |
|--------------|-------------------|-------|-----|
| Part no. | packing | mm | g |
| 88403 | 200/9.0/10.0/4.6' | 145mm | 45g |

Testing range: 110~250V AC.



Screwdriver probe voltage tester

| 88404 | | | |
|--------------|--------------------|-------|-----|
| Part no. | packing | mm | g |
| 88404 | 200/11.0/12.0/4.6' | 190mm | 55g |

Testing range: 110~250V AC.



Auto battery and charging system analyzer

| 88424 | | | |
|--------------|-----------------|-------|-----|
| Part no. | packing | mm | g |
| 88424 | 200/9.0/10.0/3' | 115mm | 45g |

Checks 12 volt system



Locking pliers

| 614 | | | |
|----------|--------------------|---------|-----|
| Part no. | packing | mm | g |
| 614125 | 40/7.6/8.6/0.7' | 125-5" | 190 |
| 614175 | 40/14.8/15.8/0.96' | 175-7" | 370 |
| 614250 | 40/22.0/23.0/1' | 250-10" | 550 |

NEW



Locking pliers (straight jaw)

| 614A | | | |
|----------|---------|--------------------|-----|
| Part no. | mm-inch | packing | g |
| 614A175 | 175-7" | 40/16.4/17.4/0.96' | 380 |
| 614A250 | 250-10" | 40/23.2/24.2/1.0' | 580 |

NEW



Locking pliers (V-jaw)

| 614B225 | | | |
|----------|---------|-----------------|-----|
| Part no. | mm-inch | packing | g |
| 614B225 | 225-9" | 40/23.0/24.0/1' | 575 |



Long nose locking pliers

| 615 | | | |
|----------|-------------------|--------|-----|
| Part no. | packing | mm | g |
| 615150 | 50/10.3/11.3/1.1' | 150-6" | 220 |
| 615225 | 50/19.5/20.5/1.2' | 225-9" | 390 |

NEW



Hose clamp pliers

| 62528 | | | |
|----------|-----|--------------------|-----|
| Part no. | mm | packing | g |
| 6252807 | 180 | 40/10.4/11.4/0.96' | 260 |
| 6252809 | 230 | 40/13.5/14.5/1' | 338 |

NEW



Locking pinch-off pliers

| 9G0115 | | |
|----------|-----|-----|
| Part no. | mm | g |
| 9G0115 | 280 | 435 |

NEW



Chain locking pliers

| 61901A | | |
|----------|-------------------|------|
| Part no. | packing | g |
| 61901A | 20/16.5/17.5/1.1' | 825g |

*Cr-Mo jaw and handle
*Welded with a 18" chain



Adjustable locking pliers

| 65202 | | | |
|----------|--------|-----------|--------|
| Part no. | Jaw | Length | Weight |
| 65202 | 3-46mm | 9"(215mm) | 400 |

* For clamping plumbing and worn screws
* Can be adjusted for clamping small to large screws
* Smooth and fast screw clamping and releasing
* Material: Jaw Cr-Mo; Body: Cr-Mo



Locking "C" clamp with easy release

| 660 | | | |
|------------------|------|--------------------|------|
| Part no. | size | packing | g |
| 66006 | 6" | 72/16.6/17.6/0.67' | 236 |
| 66011 | 11" | 30/22.5/23.5/1.2' | 750 |
| 66018 | 18" | 20/21.6/22.6/1.1' | 1200 |
| 66024 NEW | 24" | 20/23/24/1.5' | 1150 |



Sheet metal tool

| 66101 | | |
|----------|-------------------|------|
| Part no. | packing | g |
| 66101 | 48/22.0/23.0/1.2' | 458g |



Welding clamp

| 66201 | | |
|----------|-------------------|------|
| Part no. | packing | g |
| 66201 | 40/22.8/23.8/1.4' | 600g |



Self-locking multi-grip pliers

Wide flat jaws

| 67901 | | | |
|----------|-------------------|--------|--------|
| Part no. | packing | Length | Weight |
| 67901 | 36/19.5/20.5/1.9' | 200mm | 540g |

* Chrome-plated.
* For spot welding



Self-locking multi-grip pliers

Double curved jaws

| 67902 | | | |
|----------|-------------------|--------|--------|
| Part no. | packing | Length | Weight |
| 67902 | 36/19.9/20.9/1.1' | 200mm | 554g |

* Chrome-plated.
* For assembling angular shapes.



Self-locking multi-grip pliers

Wide curved jaws

| 67903 | | | |
|----------|-------------------|--------|--------|
| Part no. | packing | Length | Weight |
| 67903 | 36/18.0/19.0/1.1' | 210mm | 500g |

* Chrome-plated.
* For spot welding of metal sheets with 90° angled edges.



Self-locking multi-grip pliers Angled jaws

| 67904 | | | |
|-------------------|---------|--------|------|
| Part no. | packing | Length | g |
| 36/17.0/18.0/0.5' | | 210mm | 474g |

* Chrome-plated.
* For 90° edged metal sheets.



Self-locking multi-grip pliers Straight jaws

| 67905 | | | |
|-------------------|---------|--------|------|
| Part no. | packing | Length | g |
| 36/16.6/17.6/0.5' | | 200mm | 460g |

* Chrome-plated.
* For flat metal sheets.



Mini Straight jaws

| 67906 | | | |
|---------------|---------|--------|------|
| Part no. | packing | Length | g |
| 36/18/19/1.1' | | 200mm | 500g |

* Chrome-plated
* Clamp two sheet metal pieces of equal thickness at 90°.
* Jaw adjustment: 0-12mm
* Length:200mm



Bolt cutter

| 9U0501 | | | |
|---------------------|-------------------|----------|------|
| Part no. | packing | Length | g |
| 9U050112 | 20/16.6/17.6/2.1' | 300-12" | 830 |
| 9U050114 | 20/24/25/2.1' | 355-14" | 1200 |
| 9U050118 | 15/24.2/25.2/2.3' | 455-18" | 1613 |
| 9U050124 | 8/19/20/2.7' | 610-24" | 2375 |
| 9U050130 | 6/23.8/24.8/2.1' | 762-30" | 3967 |
| 9U050136 | 5/30.4/31.4/1.8' | 863-36" | 6080 |
| 9U050142 NEW | 3/28.0/29.0/2' | 1095-42" | 8320 |



Aluminum pipe wrench

| 684...A | | | |
|----------------|--------------------|----------|------|
| Part no. | packing | Length | g |
| 68410A | 24/11.0/12.0/0.65' | 250-10" | 460 |
| 68412A | 24/17.0/18.0/1.2' | 300-12" | 700 |
| 68414A | 12/11.5/12.5/0.6' | 355-14" | 895 |
| 68418A | 12/18.0/19.0/1.2' | 455-18" | 1500 |
| 68424A | 6/14.0/15.0/1' | 610-24" | 2330 |
| 68436A | 3/14.0/15.0/1.1' | 863-36" | 4660 |
| 68448A | 2/13.0/14.0/1' | 1220-48" | 6900 |



Pipe wrench

| 684 | | | |
|------------|--------------------|----------|-------|
| Part no. | packing | Length | g |
| 68408 | 36/14.0/15.0/0.56' | 200-8" | 390 |
| 68410 | 24/17.0/18.0/0.65' | 250-10" | 710 |
| 68412 | 24/23.0/24.0/1.2' | 300-12" | 960 |
| 68414 | 12/16.0/17.0/0.6' | 355-14" | 1340 |
| 68418 | 12/25.0/26.0/1.2' | 455-18" | 2090 |
| 68424 | 6/22.0/23.0/1' | 610-24" | 3670 |
| 68436 | 3/25.0/26.0/1.1' | 863-36" | 8340 |
| 68448 | 2/24.0/25.0/1' | 1220-48" | 12000 |



Pipe wrench

| 684C | | | | |
|-------------|--------|--------------------|-----|------|
| Part no. | size | packing | mm | g |
| 684C14 | 1" | 20/15.8/16.8/0.5' | 350 | 790 |
| 684C17 | 1-1/2" | 10/14.5/15.5/0.62' | 440 | 1450 |
| 684C22 | 2" | 10/23.5/24.5/0.96' | 560 | 2350 |



Adjustable gauged wrench

| 649 | | | | |
|------------|------|--------------------|-----|------|
| Part no. | size | packing | mm | g |
| 649150 | 20mm | 100/17.0/18.0/1.6' | 150 | 170 |
| 649200 | 24mm | 60/17.4/18.4/2.1' | 200 | 290 |
| 649250 | 29mm | 30/15.0/16.0/1.5' | 250 | 500 |
| 649300 | 33mm | 20/15.3/16.3/1.2' | 300 | 765 |
| 649375 | 46mm | 12/15.6/16.6/1.3' | 375 | 1300 |
| 649450 | 60mm | 10/19.0/20.0/0.7' | 450 | 2150 |
| 649600 | 70mm | 6/19.7/20.7/1.2' | 600 | 3280 |



Adjustable gauged wrench

| 649..A | | | | |
|---------------|------|--------------------|-----|------|
| Part no. | size | packing | mm | g |
| 649100A | 17mm | 100/9.0/10.0/1.4' | 100 | 90 |
| 649150A | 24mm | 100/14.0/15.0/1.2' | 150 | 140 |
| 649200A | 28mm | 50/13.0/14.0/1' | 200 | 260 |
| 649250A | 33mm | 30/12.7/13.7/0.77' | 250 | 423 |
| 649300A | 38mm | 20/15.3/16.3/1.2' | 300 | 765 |
| 649375A | 51mm | 12/14.3/15.3/0.9' | 375 | 1191 |



Adjustable gauged wrench (left-threaded)

| 649...AL | | | | |
|-----------------|------|--------------------|-----|------|
| Part No. | Size | Packing | mm | g |
| 649100AL | 17 | 100/9.0/10.0/1.4' | 100 | 60 |
| 649150AL | 25 | 100/14.0/15.0/1.2' | 150 | 120 |
| 649200AL | 30 | 50/13.0/14.0/1' | 200 | 260 |
| 649250AL | 31 | 30/12.7/13.7/0.77' | 250 | 380 |
| 649300AL | 40 | 20/15.3/16.3/1.2' | 300 | 600 |
| 649375AL | 50 | 12/14.3/15.3/0.9' | 375 | 1180 |



Adjustable gauged wrench

| 649..B | | | | |
|---------------|------|-------------------|-----|-----|
| Part no. | size | packing | mm | g |
| 649200B | 24mm | 60/18.0/19.0/2.1' | 200 | 290 |
| 649250B | 29mm | 30/15.0/16.0/1.5' | 250 | 500 |
| 649300B | 33mm | 20/15.3/16.3/1.3' | 300 | 765 |

NEW



BV series adjustable wrench

| 649200C | | | |
|----------------|-----------------|-----|-----|
| Part no. | Packing | mm | g |
| 649200C | 50/16.0/17.0/1' | 200 | 280 |

*Material : Chrome Vanadium
*Type : Screw pin w/front side metric scale.
*Hot Forged Handle and Jaw
*Whole piece with heat treatment
*Perfectly matched knurl and teeth of jaw for smooth running
*Exceed World-Wide industrial standard specification
*Over standard jaw opening, approach 38mm
*TPR handle w/end hole button

NEW



Ratchet-function adjustable wrench

| 649200D | | | |
|----------------|-----------------|-----|-----|
| Part no. | Packing | mm | g |
| 649200D | 40/10.8/11.8/1' | 200 | 270 |

*Material: Chrome Vanadium
*Patented ratchet-function jaw
*Comfortable and strong TPR handle



Tone control torques wrench

| 647 Part no. | Capacity Nm | Packing | l mm | g |
|--------------|----------------|--------------------|------|------|
| 6472270 | 1/4"DR. 5-25 | 20/15.4/16.4/1.19' | 270 | 770 |
| 6473270 | 3/8"DR. 5-25 | 20/15.5/16.5/1.19' | 270 | 775 |
| 6473365 | 19-110 | 20/21.5/22.5/1.46' | 365 | 1075 |
| 6474470 | 1/2"DR. 42-210 | 12/19.8/20.8/1.1' | 470 | 1650 |
| 6474630 | 70-350 | 10/28.7/29.7/1.4' | 630 | 2870 |
| 6476850 | 3/4"DR. 65-450 | 4/18.1/19.1/1.7' | 850 | 4525 |
| 64761030 | 140-700 | 4/30.3/31.3/1.67' | 1030 | 7575 |
| 64761215 | 140-980 | 2/16.2/17.2/1.13' | 1215 | 8100 |
| 64781215 | 1"DR. 140-980 | 2/16.3/17.3/1.13' | 1215 | 8150 |
| Part no. | Inch-lb | Packing | mm | g |
| 6472270S | 1/4"DR. 10-200 | 20/14.4/15.4/1.14' | 270 | 720 |
| 6473270S | 3/8"DR. 10-200 | 20/14.8/15.8/1.14' | 270 | 740 |
| Part no. | Ft-lb | Packing | mm | g |
| 6473365S | 3/8"DR. 5-80 | 20/21.0/22.0/1.14' | 365 | 1050 |
| 6474470S | 1/2"DR. 10-150 | 12/20.2/21.2/1.1' | 470 | 1685 |
| 6474630S | 50-250 | 4/11.2/12.2/0.92' | 630 | 2800 |
| 6476850S | 3/4"DR. 50-300 | 4/19.0/20.0/1.7' | 850 | 4750 |
| 64761030S | 100-600 | 4/30.0/31.0/1.67' | 1030 | 7500 |
| 64761215S | 100-700 | 2/15.0/16.0/0.8' | 1215 | 7500 |
| 64781215S | 1"DR. 100-700 | 2/15.0/16.0/0.8' | 1215 | 7500 |

• Spare part available



Lock torques wrench (tone control)

| 647 Part no. | Capacity Nm | Packing | l mm | g |
|----------------------|-----------------|--------------------|------|-------|
| 6472295 | 1/4"DR. 6-30 | 20/19.0/20.0/1.12' | 295 | 950 |
| 6473295 | 3/8"DR. 6-30 | 20/18.1/19.1/1.12' | 295 | 905 |
| 6473380 | 19-110 | 12/13.7/14.7/1.57' | 380 | 1140 |
| 6474535 | 1/2"DR. 40-210 | 10/21.0/22.0/1.31' | 535 | 2100 |
| 6474660 | 70-350 | 6/17.9/18.9/0.92' | 660 | 2980 |
| 6476880 | 3/4"DR. 100-500 | 4/18.7/19.7/1.07' | 880 | 4675 |
| 64761095 | 140-700 | 4/31.0/32.0/1.93' | 1095 | 7750 |
| 64761240 | 140-980 | 4/30.3/31.1/1.93' | 1240 | 7575 |
| 64781240 | 1"DR. 140-980 | 2/16.2/17/1.13' | 1240 | 8100 |
| 64781700 NEW | 300-1500 | 1/12.0/13.0/0.9' | 1700 | 11580 |
| Part no. | Inch-lb | Packing | mm | g |
| 6472295S | 1/4"DR. 40-250 | 20/17.2/18.2/1.63' | 295 | 860 |
| 6473295S | 3/8"DR. 40-250 | 20/17.2/18.2/1.63' | 295 | 860 |
| Part no. | Ft-lb | Packing | mm | g |
| 6473380S | 3/8"DR. 15-80 | 8/9.1/10.1/0.76' | 380 | 1140 |
| 6474535S | 1/2"DR. 30-150 | 6/12.6/13.6/1.31' | 535 | 2100 |
| 6474660S | 50-250 | 6/17.7/18.7/0.92' | 660 | 2950 |
| 6476880S | 3/4"DR. 50-300 | 5/23.7/24.7/1.7' | 880 | 4740 |
| 64761095S | 100-600 | 4/30.0/31.0/1.8' | 1095 | 7500 |
| 64761240S | 100-700 | 2/16.0/17.0/1' | 1240 | 8000 |
| 64781240S | 1"DR. 100-700 | 2/16.0/17.0/1' | 1240 | 8000 |
| 64781700S NEW | 200-1000 | 1/12.0/13.0/0.9' | 1700 | 11580 |

• Spare part available



Lock torques wrench (tone control)

| 647 Part no. | Capacity Nm | Packing | l mm | g |
|--------------|------------------|--------------------|------|------|
| 6473383 | 3/8" DR. 15-80 | 12/12.5/13.1/0.76' | 383 | 740 |
| 6473385 | 19-110 | 12/14.0/15.0/0.76' | 383 | 960 |
| 6474536 | 1/2" DR. 40-210 | 10/20.6/21.2/1.3' | 535 | 1070 |
| 6474645 | 70-350 | 6/18.4/19.0/0.92' | 645 | 2540 |
| 6476865 | 3/4" DR. 100-500 | 4/19.5/20.5/1.1' | 865 | 3660 |
| 64761088 | 140-700 | 4/30.0/31.0/1.9' | 1088 | 5940 |
| 64761230 | 140-980 | 2/16.0/17.0/1.1' | 1230 | 6460 |
| 64781230 | 1"DR. 140-980 | 2/16.0/17.0/1.1' | 1230 | 6460 |
| Part no. | Ft-lb | Packing | mm | g |
| 6473383S | 3/8" DR. 10-60 | 12/12.5/13.1/0.76' | 383 | 740 |
| 6473385S | 15-80 | 12/14.0/15.0/0.76' | 383 | 960 |
| 6474536S | 1/2" DR. 30-150 | 10/20.6/21.2/1.3' | 535 | 1070 |
| 6474645S | 50-250 | 6/18.4/19.0/0.92' | 645 | 2540 |
| 6476865S | 3/4" DR. 50-300 | 4/19.5/20.5/1.1' | 865 | 3660 |
| 64761088S | 100-600 | 4/30.0/31.0/1.9' | 1088 | 5940 |
| 64761230S | 100-700 | 2/16.0/17.0/1.1' | 1230 | 6460 |
| 64781230S | 1"DR. 100-700 | 2/16.0/17.0/1.1' | 1230 | 6460 |

• Spare part available



Clock wise click for right thread nut



Anti-clock wise click for left thread nut



Lock torques wrench (tone control)

| 647...W Part no. | Capacity | Packing | l mm | g |
|------------------|------------------------------|--------------------|------|------|
| 6472300W | 1/4"DR. 6-30Nm 40-250in-lb | 20/16.0/17.0/1.63' | 300 | 800 |
| 6473420W | 3/8"DR. 20-100Nm 15-75ft-lb | 12/16.8/17.8/1.57' | 420 | 1400 |
| 6474530W | 1/2"DR. 40-200Nm 30-150ft-lb | 10/16.0/17.0/1.31' | 530 | 1600 |

• Spare part available



Lock torques wrench - window display

| 647...W Part no. | Capacity Nm | l mm | g |
|------------------|------------------|------|------|
| 6472290W | 1/4" DR. 1~25 | 290 | 420 |
| 6473360W | 3/8" DR. 5~50 | 360 | 920 |
| 6474405W | 1/2" DR. 10~100 | 405 | 1020 |
| 6474500W | 20~200 | 500 | 1200 |
| 6474595W | 60~300 | 595 | 1330 |
| 6474680W | 80~400 | 680 | 1820 |
| 6476970W | 3/4" DR. 100~550 | 970 | 3700 |

• Spare part available

NEW **TORQUE**



Lock torques wrench-window display (Tone control)

| Part no. | Capacity | l mm | g |
|----------|-------------------|---------|-----|
| 6472195W | 1/4"DR. 3-15Nm | 195 | 215 |

*Nm in display only.

NEW



Lock torques wrench (tone control)

| Part no. | Capacity Nm | packing | g |
|----------|----------------|------------------|-----|
| 64721602 | 0.4-2 | 30/6.0/6.5/0.7 | 200 |
| 64721605 | 1-5 | 30/10.8/11.8/0.7 | 360 |
| 64721608 | 1.5-8 | 30/10.8/11.8/0.7 | 360 |

NEW

TORQUE

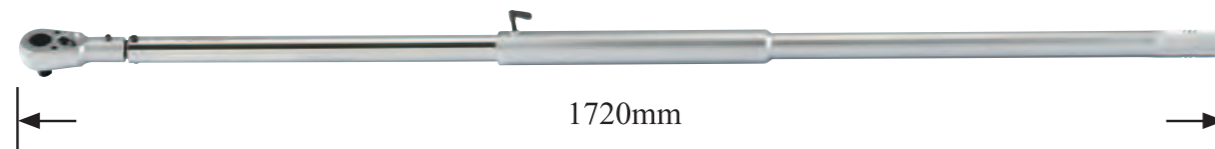
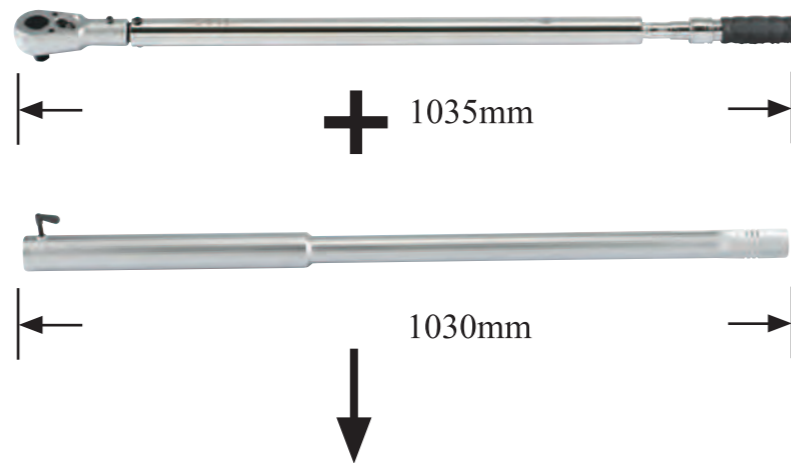

Double click torque wrench

| Part no. | Capacity | l mm | kg |
|----------|-----------------------|---------|----|
| 647A602 | 3/4"DR. 300~1500Nm | 1720 | 12 |
| 647A602S | 200~1000Ft-lb | 1720 | 12 |
| 647A802 | 1"DR. 300~1500Nm | 1720 | 12 |
| 647A802S | 200~1000Ft-lb | 1720 | 12 |

• Spare part available

NEW



**Torque handle fittings
(24 Teeth Ratchet head,9x12mm)**

| Part No. | DR. | l mm | g |
|----------|--------------------------|---------|-----|
| 647H209 | 1/4" | 56 | 84 |
| 647H309 | 3/8" | 69 | 177 |
| 647H309A | 3/8" (small, width 27mm) | 56 | 89 |
| 647H409 | 1/2" | 69 | 185 |

NEW



**Torque handle fittings
(Open end wrench head, 9x12mm)**

| Part No. | Size (mm) | Part No. | Size (inch) |
|----------|-----------|------------|-------------|
| 6850907 | 7 | 685095.16 | 5/16 |
| 6850908 | 8 | 685093.8 | 3/8 |
| 6850909 | 9 | 685097.16 | 7/16 |
| 6850910 | 10 | 685099.16 | 9/16 |
| 6850911 | 11 | 685095.8 | 5/8 |
| 6850912 | 12 | 6850911.16 | 11/16 |
| 6850913 | 13 | 685093.4 | 3/4 |
| 6850914 | 14 | | |
| 6850915 | 15 | | |
| 6850916 | 16 | | |
| 6850917 | 17 | | |
| 6850918 | 18 | | |
| 6850919 | 19 | | |

NEW



**Torque handle fittings
(72 Teeth round ratchet head 9x12mm)**

| Part No. | DR. | l mm | g |
|------------|------|---------|-----|
| 647H209-72 | 1/4" | 42.3 | 70 |
| 647H309-72 | 3/8" | 48.75 | 100 |
| 647H409-72 | 1/2" | 56.5 | 190 |

NEW



**Torque handle fittings
(Box end wrench head, 9x12mm)**

| Part No. | DR. | l mm | g |
|----------|-----|---------|----|
| 685A0907 | 7 | 40.6 | 42 |
| 685A0908 | 8 | 40.6 | 42 |
| 685A0909 | 9 | 42.1 | 42 |
| 685A0910 | 10 | 42.1 | 50 |
| 685A0911 | 11 | 43.5 | 50 |
| 685A0912 | 12 | 43.5 | 50 |
| 685A0913 | 13 | 47 | 60 |
| 685A0914 | 14 | 47 | 64 |
| 685A0915 | 15 | 48.2 | 64 |
| 685A0916 | 16 | 48.2 | 62 |
| 685A0917 | 17 | 51.5 | 76 |
| 685A0918 | 18 | 51.5 | 74 |
| 685A0919 | 19 | 51.5 | 72 |
| 685A0921 | 21 | 50.5 | 68 |
| 685A0922 | 22 | 51.5 | 70 |

NEW



**Torque handle fittings
(Flare nut wrench head, 9x12mm)**

| Part No. | DR. | Part No. | DR. |
|----------|-----|----------|-----|
| 685B0910 | 10 | 685B0917 | 17 |
| 685B0911 | 11 | 685B0918 | 18 |
| 685B0912 | 12 | 685B0919 | 19 |
| 685B0913 | 13 | 685B0921 | 21 |
| 685B0914 | 14 | 685B0922 | 22 |
| 685B0916 | 16 | | |

NEW



**Torque handle fittings
(Open end wrench head, 14x18mm)**

| Part No. | Size (mm) | Part No. | Size (inch) |
|----------|-----------|------------|-------------|
| 6851413 | 13 | 685149.16 | 9/16 |
| 6851414 | 14 | 685145.8 | 5/8 |
| 6851415 | 15 | 6851411.16 | 11/16 |
| 6851416 | 16 | 685143.4 | 3/4 |
| 6851417 | 17 | 6851413.16 | 13/16 |
| 6851418 | 18 | 685147.8 | 7/8 |
| 6851419 | 19 | 6851415.16 | 15/16 |
| 6851421 | 21 | 685141.1.4 | 1-1/4 |
| 6851422 | 22 | | |
| 6851424 | 24 | | |
| 6851426 | 26 | | |
| 6851427 | 27 | | |
| 6851429 | 29 | | |
| 6851430 | 30 | | |
| 6851432 | 32 | | |

NEW



**Torque handle fittings
(Single hook spanner head, 14x18mm)**

| Part No. | Size (mm) |
|----------|----------------------|
| 685C1443 | 43±5mm |
| 685C1460 | 60±5mm |
| 685C1472 | 72±5mm |
| 685C1450 | 50±5mm |
| 685C1463 | 63.2±5mm |
| 685C1482 | 82±5mm |
| 685C1432 | 32±5mm (strong type) |

NEW

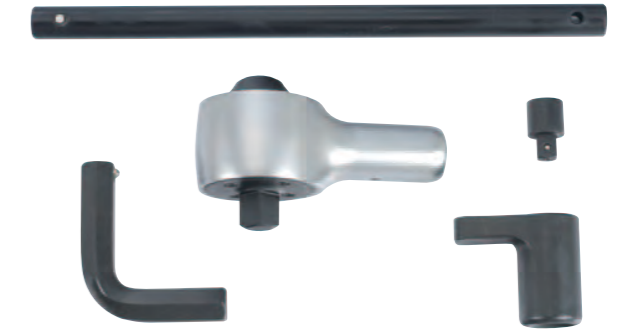

Torque multiplier set

| Part no. | 3/10.5/11.5/1.2' | 3500g |
|----------|---|-------|
| 65111 | Contents: 2-Torque multiplier head & 380mm reaction bar 1/2"(F)x3/4"(M) Max output 1500Nm | |
| 65111L-1 | 1-90° Reaction bar | |
| 65111L-2 | 1-90° Reaction base | |
| 65111L-3 | 1-Break-away adapter | |

*Always apply the break-away adapter in order to protect the torque multiplier from damage.
*The break-away adapter is expendable.

NEW



**Torque handle fittings
(24 Teeth Ratchet head, 14x18mm)**

| Part No. | DR. |
|----------|---------------------------|
| 647H314 | 3/8" |
| 647H414 | 1/2" |
| 647H414A | 1/2" (small, width 36 mm) |

NEW



**Torque handle fittings
(Box end wrench head, 14x18mm)**

| Part No. | Size (mm) | Part No. | Size (mm) |
|----------|-----------|----------|-----------|
| 685A1413 | 13 | 685A1426 | 26 |
| 685A1414 | 14 | 685A1427 | 27 |
| 685A1415 | 15 | 685A1430 | 30 |
| 685A1416 | 16 | 685A1432 | 32 |
| 685A1417 | 17 | 685A1434 | 34 |
| 685A1418 | 18 | 685A1436 | 36 |
| 685A1419 | 19 | 685A1438 | 38 |
| 685A1421 | 21 | 685A1441 | 41 |
| 685A1422 | 22 | 685A1442 | 42 |
| 685A1424 | 24 | | |

NEW



**Torque handle fittings
(Double hook spanner head, 14x18mm)**

| Part No. | Size (mm) |
|----------|-----------|
| 685D1432 | 31.6±5mm |
| 685D1435 | 34.9±5mm |
| 685D1442 | 41.9±5mm |
| 685D1450 | 50±5mm |
| 685D1463 | 62.9±5mm |

NEW



Torque multiplier set

| Part no. | 3/10.5/11.5/1.2' | 3500g |
|----------|---|-------|
| 65112 | Contents: 2-Torque multiplier head & 380mm reaction bar 1/2"(F)x1"(M) Max output 2000Nm | |
| 65112L-1 | 1-90° Reaction bar | |
| 65112L-2 | 1-90° Reaction base | |
| 65112L-3 | 1-Break-away adapter | |

*Always apply the break-away adapter in order to protect the torque multiplier from damage.
*The break-away adapter is expendable.

NEW



**Torque handle fittings
(72 Teeth Ratchet head, 14x18mm)**

| Part No. | DR. |
|------------|------|
| 647H314-72 | 3/8" |
| 647H414-72 | 1/2" |

NEW



Torque multiplier set

| Part no. | 3/10.5/11.5/1.2' | 3500g |
|----------|---|-------|
| 65113L | | |
| 65113 | Contents: 2-Torque multiplier head & 380mm reaction bar 3/4"(F)x1"(M) Max output 2500Nm | |
| 65113L-1 | 1-90° Reaction bar | |
| 65113L-2 | 1-90° Reaction base | |
| 65113L-3 | 1-Break-away adapter | |

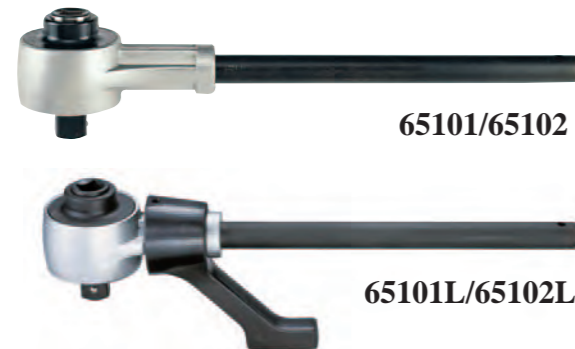

Mechanical Torque Multipliers

| 651 | Max. Output | Square Drive | Ratio |
|----------|-------------|--------------|-------|
| Part no. | Nm / Ft-lb | size | |
| 65101 | 1500/1100 | 1/2" to 3/4" | 1:3 |
| 65102 | 3000/2200 | 3/4" to 1" | 1:3 |

| 651 | Max. Input | | |
|----------|------------|-------------------|------|
| Part no. | Nm / Ft-lb | Packing | g |
| 65101 | 500/365 | 4/14.4/15.4/0.75' | 3600 |
| 65102 | 1000/730 | 4/19.4/20.4/1' | 4850 |

*Spare part available
*Impact use is prohibited
*65101L / 65102L: Supplied with the reaction bar styles for maximum versatility.

NEW



Torque multipliers

| 651 | Drive | Gear ratio | Torque ratio | Max. input | Max output |
|-------|-----------------|------------|--------------|------------|------------|
| 65111 | 1/2"(F)x3/4"(M) | 1:9 | 1:6.5 | 231Nm | 1500Nm |
| 65112 | 1/2"(F)x1"(M) | 1:16 | 1:12 | 222Nm | 2000Nm |
| 65113 | 3/4"(F)x1"(M) | 1:4 | 1:3.3 | 758Nm | 2500Nm |

*Option: 65111L-3 Break-away adapter for 65111L
65112L-3 Break-away adapter for 65112L
*Always apply the break-away adapter in order to protect the torque multiplier from damage.
*The break-away adapter is expendable.

NEW



Torque multiplier

| 65103 | Packing | Ratio | |
|----------|-------------------|-------|-------|
| Part no. | 4/15.6/16.6/0.96' | 1:9 | 3.9kg |

*Max. input: 1/2"(F) 160Nm / 120 Ft-lb
*Max. output: 3/4"(M) 1500Nm / 1100 Ft-lb
*Impact use is prohibited

NEW



Mechanical Torque Multipliers

| 651 | Drive | Torque Ratio | Max. input | Max. output |
|-------|-----------------|--------------|------------|-------------|
| 65106 | 1/2"(F)x3/4"(M) | 1:5 | 260Nm | 1300Nm |
| 65107 | 3/4"(F)x1"(M) | 1:5 | 540Nm | 2700Nm |

*Material: SCM440 (4140)
*Finish: Manganese phosphate



Torque adapter (spark plug special)

| 832 | Torque | <i>l</i> | | | |
|----------|---------|----------|----|-----|--------|
| Part no. | size | Nm | mm | g | Pc/box |
| 832318 | 3/8"DR. | 18 | 52 | 170 | 5 |
| 832324 | 3/8"DR. | 24 | 52 | 170 | 5 |



Torque wrench calibrator

| 6991015 | | |
|----------|------------------|--------|
| Part no. | 1/8.86/9.5/18.2' | 88.6kg |

* ETS Display AC 110C/220V
*TRANSDUCER 40~1000Nm
* LOADER 1500mmL
* The test and report software included



Flexible hex nut driver

| 648 | | <i>l</i> | <i>l</i> | | |
|----------|-------|----------|----------|-----|-----------|
| Part no. | size | Blade | over | g | Pc/carton |
| 648055 | 5.5 | 160 | 270 | 190 | 60/2.5' |
| 64806 | 6 | 160 | 270 | 192 | 60/2.5' |
| 64807 | 7 | 160 | 270 | 196 | 60/2.5' |
| 64808 | 8 | 160 | 270 | 198 | 60/2.5' |
| 6481.4 | 1/4" | 160 | 270 | 192 | 60/2.5' |
| 6485.16 | 5/16" | 160 | 270 | 198 | 60/2.5' |



Flexible hex nut driver

| 648...L | | <i>l</i> | <i>l</i> | | |
|----------|------|----------|----------|-----|-----------|
| Part no. | size | L | over | g | Pc/carton |
| 648055L | 5.5 | 500 | 630 | 275 | 60/2.4' |
| 64806L | 6 | 500 | 630 | 275 | 60/2.4' |
| 64807L | 7 | 500 | 630 | 275 | 60/2.4' |
| 64808L | 8 | 500 | 630 | 275 | 60/2.4' |



Flexible hex nut driver

| 6480607 | | <i>l</i> | <i>l</i> | | |
|----------|------|----------|----------|-----|-----------|
| Part no. | size | Blade | over | g | Pc/carton |
| 6480607 | 6x7 | 190 | 290 | 220 | 60/2.5' |



Spline screwdriver M4

| 71817004A | | <i>l</i> | | |
|-----------|----|----------|-----|------|
| Part no. | M4 | 80mm | 35g | 10PC |

* For removing & fitting the internal covering of tail lamps and dashboards as fitted to the Golf IV & new AUDI / VW models.
* For door handle VW passat and Golf IV.



Adjustment phillips screwdriver

| 6551 | | <i>l</i> | <i>l</i> | | |
|----------|------|----------|----------|----|--------|
| Part no. | size | Blade | over | g | pc/box |
| 65511 | PH.1 | 350 | 450 | 75 | 10 |
| 65512 | PH.2 | 350 | 450 | 75 | 5 |



Adjustment phillips screwdriver

| 6551...L | | <i>l</i> | <i>l</i> | |
|----------|------|----------|----------|-----|
| Part no. | size | Blade | over | g |
| 65512L | PH.2 | 400 | 515 | 215 |

Adjustment pozidriv screwdriver

| 6552...L | | <i>l</i> | <i>l</i> | |
|----------|------|----------|----------|-----|
| Part no. | size | Blade | over | g |
| 65522L | PZ.2 | 400 | 515 | 215 |



Adjustment slotted screwdriver

| 6553 | | <i>l</i> | <i>l</i> | | |
|----------|------|----------|----------|----|--------|
| Part no. | size | Blade | over | g | pc/box |
| 655304 | 4 | 300 | 400 | 65 | 10 |
| 655305 | 5 | 300 | 400 | 65 | 10 |
| 655306 | 6 | 300 | 400 | 65 | 10 |
| 655308 | 8 | 300 | 400 | 70 | 5 |



Adjustment slotted screwdriver

| 6553...L | | <i>l</i> | <i>l</i> | |
|----------|------|----------|----------|-----|
| Part no. | size | Blade | over | g |
| 6553065L | 6.5 | 400 | 515 | 215 |



Rim wrench

| 677 | <i>l</i> | | | |
|---------------------|----------|-----|------|--------|
| Part no. | Size | mm | g | pc/box |
| 6771921 NEW | 19x21 | 300 | 1000 | 5 |
| 6772224 | 22x24 | 400 | 1300 | 5 |
| 6772427 | 24x27 | 400 | 1320 | 5 |
| 6772432S NEW | 24x32 | 400 | 1330 | 5 |
| 6772730 | 27x30 | 400 | 1330 | 5 |
| 6772732 | 27x32 | 400 | 1380 | 5 |
| 6772733 | 27x33 | 400 | 1400 | 5 |
| 6772833 | 28x33 | 400 | 1410 | 5 |
| 6773032 | 30x32 | 400 | 1440 | 5 |
| 6773233 NEW | 32x33 | 400 | 1495 | 5 |
| 6773238 | 32x38 | 400 | 1535 | 5 |
| 6773821 | 38x21sq. | 400 | 1520 | 5 |
| 6773822 NEW | 38x22sq. | 400 | 1520 | 5 |
| 6774121 | 41x21sq. | 400 | 1550 | 2 |
| 6774121L NEW | 41x21sq. | 450 | 1800 | 1 |



Wrench bar

| 677 | <i>l</i> | | |
|---------------------|----------|-----|------|
| Part no. | Size | mm | g |
| 67701 | 19 | 630 | 1400 |
| 67702 | 25 | 630 | 3500 |
| 67701400 NEW | 19 | 400 | 890 |
| 67703 NEW | 16 | 400 | 630 |

*67702 only for 6773821 and 6774121L

*67703 only for 6771921



Foldable cross-handle socket wrench

| 681 | | |
|----------|--------------------|------|
| Part no. | Packing | g |
| 681400 | 16/18.7/19.7/1.3' | 1170 |
| 681500 | 16/23.4/24.4/1.57' | 1463 |

Socket size: 17mm; 19mm; 21mm; 1/2" square
Length: 681400: 16" = 400mmL
681500: 20" = 500mmL



Assembly wheel nut wrench

| 681A300 | | |
|----------|---|-------|
| Part no. | 20/23.0/24.0/0.64' | 1150g |
| 681A300 | 17mm; 19mm; 13/16"; 1/2"DR. (300mmL) * Chrome vanadium alloy steel * For most car wheel nuts in metric * Polished, chrome plated | |



Wheel nut wrench

| 681B400 | | |
|----------|--|-------|
| Part no. | 12/16.8/17.3/0.9' | 1600g |
| 681B400 | 17; 19; 21; 22 mm with 1/2"DR. Adapter (400mmL) * Chrome vanadium alloy steel * For most car wheel nuts in metric * Polished, chrome plated | |



Wheel balancing weight tool

| 6821 | | <i>l</i> | |
|----------|-------------------|----------|------|
| Part no. | 30/11.6/12.6/1.2' | 245mm | 388g |



Tyre lever

| 750 | | <i>l</i> | | |
|--------------------|---------------------|----------|------|--------|
| Part no. | packing | mm | g | pc/box |
| 750200 NEW | 100/14.6/15.6/0.56' | 200 | 162 | 10 |
| 750300 NEW | 120/31.6/32.6/0.6' | 300 | 370 | 10 |
| 750380 NEW | 60/22.9/23.9/0.5' | 380 | 556 | 10 |
| 750500 | 30/22.0/23.0/0.75' | 500 | 732 | 5 |
| 750525B NEW | 30/28.3/29.3/0.71' | 525 | 925 | 5 |
| 750650 NEW | 20/23.2/24.2/0.34' | 650 | 1160 | 5 |
| 750650B NEW | 20/21.8/22.8/0.47' | 650 | 1160 | 5 |



Brake spanner

| 608 | <i>l</i> | | | |
|----------|---------------------|-----|-----|--------|
| Part no. | size | mm | g | pc/box |
| 6080610 | 1/4" Sq.-10mmSq. | 175 | 82 | 10 |
| 6080608 | 1/4" Sq.-5/16"OE. | 175 | 84 | 10 |
| 6080810 | 8mmHex.-10mmHex. | 175 | 82 | 10 |
| 6080911 | 9mmHex.-11mmHex. | 175 | 100 | 10 |
| 6080607 | 1/4"Hex.-7mmHex. | 175 | 84 | 10 |
| 6081109 | 7/16"OE.-11/32" Sq. | 175 | 100 | 10 |
| 6081114 | 7/16"OE.-9/16.OE. | 175 | 102 | 10 |
| 6081113 | 11mmOE.-13mmOE. | 175 | 108 | 10 |
| 6081011 | 10mmOE.-11mmOE. | 175 | 92 | 10 |



1/2" Pentagon socket bit 10mm side

| Part no. | Bit | 55mm | 94g | 10pc |
|--------------|-----|----------|-----|------|
| 65001 | | <i>l</i> | | |

*Application on girling brakes.



1/2"DR. Pentagon socket 14mm / 19mm

| Part no. | size | pc/box |
|------------|------|--------|
| 650 | | |
| 65014 | 14mm | |
| 65019 | 19mm | |

14mm : for pentagon brakes on rear brake, Opel Astra G, Zafira, Smart

19mm : for Bendix brakes, Citroën, Peugeot, Renault



1/2"DR. Bent hex socket bit

| Part no. | size | length | weigth | pcs/box |
|------------------|------|----------|--------|---------|
| 34410508B | | <i>l</i> | | |
| 34410508B | 8mm | 105mm | 92gw | 10 |



3/8" DR. Universal star socket bit

| Part no. | Tip | mm | g | pc/box |
|---------------|-----|----------|----|--------|
| 336..U | | <i>l</i> | | |
| 33645U | T45 | 65 | 68 | 10 |
| 33650U | T50 | 65 | 70 | 10 |

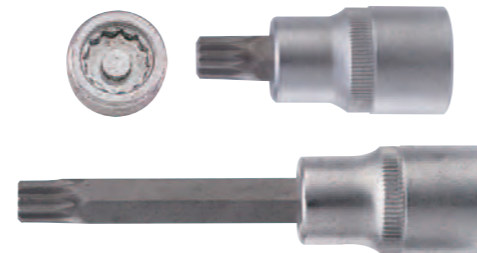

1/2" DR. Spline Security socket bit

| Part no. | size | mm | g | pc/box |
|---------------|------|----------|-----|--------|
| 348..T | | <i>l</i> | | |
| 34805516T | M16 | 55 | 142 | 10 |
| 34810016T | M16 | 100 | 270 | 10 |

* For removal and replacement of the gear box drain plug Audi A3, A4, A6; VW Golf IV, LT.



3/4" DR. Star impact deep socket

| Part no. | socket | mm | g | pc/box |
|---------------|--------|----------|-----|--------|
| 466110 | | <i>l</i> | | |
| 46611018 | E18 | 110 | 520 | 1 |
| 46611020 | E20 | 110 | 540 | 1 |
| 46611024 | E24 | 110 | 591 | 1 |

* E20 For HGV Cylinder-head bolts.



3/8" DR. Magnetic Long Spark plug socket

| Part no. | socket | mm | g | pc/box |
|-------------------|--------|----------|-----|--------|
| 8073250..M | | <i>l</i> | | |
| 807325014M | 14mm | 250 | 316 | 10 |
| 807325016M | 16mm | 250 | 344 | 10 |
| 807325020.6M | 20.6mm | 250 | 440 | 10 |

* 807325014M for Citroën C5 HPI, Peugeot 406 HPI, Renault Clio 1,2 16V; Twingo 1,2 16V.



1/2" DR. Magnetic Spark plug socket

| Part no. | size | mm | g | pc/box |
|----------------|--------|----------|-----|--------|
| 8074..M | | <i>l</i> | | |
| 807414M | 14mm | 70 | 67 | 10 |
| 807416M | 16mm | 70 | 86 | 10 |
| 807418M | 18mm | 70 | 146 | 10 |
| 807420.6M | 20.6mm | 70 | 148 | 10 |

* E20 For HGV Cylinder-head bolts.



1/2"DR. Vacuum switch socket

| Part no. | size | mm | g | pc/box |
|-----------------------------|------|----------|-----|--------|
| 443 | | <i>l</i> | | |
| 44322 | 22 | 85 | 230 | 10 |
| 44327 | 27 | 85 | 389 | 10 |
| 44315022 <small>NEW</small> | 22 | 150 | 450 | 10 |



3/8" DR. Universal Spark plug socket (ball type)

| Part no. | socket | mm | g | pc/box |
|----------------|--------|----------|-----|--------|
| 8073..B | | <i>l</i> | | |
| 807316B | 16mm | 95 | 114 | 10 |
| 807320.6B | 20.6mm | 95 | 150 | 10 |



3/8" DR. Universal Spark plug socket Magnetic (ball type)

| Part no. | socket | mm | g | pc/box |
|-----------------|--------|----------|-----|--------|
| 8073..BM | | <i>l</i> | | |
| 807316BM | 16mm | 95 | 118 | 10 |
| 807320.6BM | 20.6mm | 95 | 154 | 10 |



3/8" DR. Universal Spark T wrench (ball type)

| Part no. | socket | mm | g |
|----------------|--------|----------|-----|
| 8073..B | | <i>l</i> | |
| 807330016B | 16mm | 300 | 354 |
| 807330020.6B | 20.6mm | 300 | 392 |
| 807350016B | 16mm | 500 | 552 |
| 807350020.6B | 20.6mm | 500 | 590 |



**3/8" DR. Universal Spark T wrench
Magnetic (ball type)**

| Part no. | socket | mm | g |
|---------------|--------|-----|-----|
| 807330016BM | 16mm | 300 | 356 |
| 807330020.6BM | 20.6mm | 300 | 394 |
| 807350016BM | 16mm | 500 | 554 |
| 807350020.6BM | 20.6mm | 500 | 592 |



**3/8" DR. Universal spark plug socket
Magnetic (joint type)**

| Part no. | socket | mm | g | pc/box |
|------------|--------|----|-----|--------|
| 807316UM | 16mm | 95 | 114 | 10 |
| 807320.6UM | 20.6mm | 95 | 150 | 10 |

**1/2" DR. Universal spark plug socket
Magnetic (joint type)**

| Part no. | socket | mm | g | pc/box |
|------------|--------|-----|-----|--------|
| 807416UM | 16mm | 100 | 102 | 10 |
| 807420.6UM | 20.6mm | 100 | 164 | 10 |



**1/2" DR. Universal spark plug socket
(joint type)**

| Part no. | socket | mm | g | pc/box |
|-----------|--------|----|-----|--------|
| 807316U | 16mm | 95 | 114 | 10 |
| 807320.6U | 20.6mm | 95 | 150 | 10 |

**1/2" DR. Universal spark plug socket
(joint type)**

| Part no. | socket | mm | g | pc/box |
|-----------|--------|-----|-----|--------|
| 807416U | 16mm | 100 | 102 | 10 |
| 807420.6U | 20.6mm | 100 | 164 | 10 |

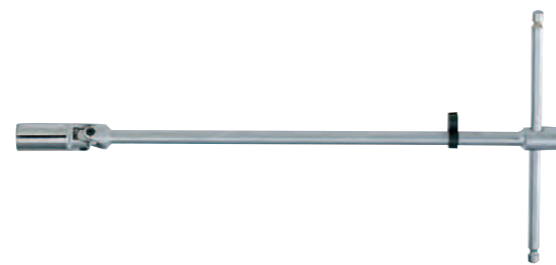

**3/8" DR. Universal spark T wrench
Magnetic (joint type)**

| Part no. | socket | mm | g |
|---------------|--------|-----|-----|
| 807330016UM | 16mm | 300 | 356 |
| 807330020.6UM | 20.6mm | 300 | 394 |
| 807350016UM | 16mm | 500 | 554 |
| 807350020.6UM | 20.6mm | 500 | 592 |
| 807380016UM | 16mm | 800 | 852 |
| 807380020.6UM | 20.6mm | 800 | 890 |

**1/2" DR. Universal spark T wrench
Magnetic (joint type)**

| Part no. | socket | mm | g |
|---------------|--------|-----|-----|
| 807430016UM | 16mm | 300 | 356 |
| 807430020.6UM | 20.6mm | 300 | 394 |
| 807450016UM | 16mm | 500 | 554 |
| 807450020.6UM | 20.6mm | 500 | 592 |
| 807480016UM | 16mm | 800 | 852 |
| 807480020.6UM | 20.6mm | 800 | 890 |



3/8" DR. Universal Spark T wrench(joint type)

| Part no. | socket | mm | g |
|--------------|--------|-----|-----|
| 807330016U | 16mm | 300 | 354 |
| 807330020.6U | 20.6mm | 300 | 392 |
| 807350016U | 16mm | 500 | 552 |
| 807350020.6U | 20.6mm | 500 | 590 |
| 807380016U | 16mm | 800 | 850 |
| 807380020.6U | 20.6mm | 800 | 888 |

1/2" DR. Universal Spark T wrench(joint type)

| Part no. | socket | mm | g |
|--------------|--------|-----|------|
| 807430016U | 16mm | 300 | 646 |
| 807430020.6U | 20.6mm | 300 | 684 |
| 807450016U | 16mm | 500 | 936 |
| 807450020.6U | 20.6mm | 500 | 974 |
| 807480016U | 16mm | 800 | 1150 |
| 807480020.6U | 20.6mm | 800 | 1188 |



Oil filter strap wrench

| Part no. | 60/14.0/15.0/3' | 150mm | 233g |
|----------|-----------------|-------|------|
| 619 | | | |

It can match with various tools for use 1/2" driver, pliers and screwdriver.



Three-legged two way oil filter spiral wrench

| Part no. | 36/15.0/16.0/1' | 415g |
|----------|-----------------|------|
| 61904A | | |

* Fits 1/2" & 3/8" Square Drive Ratchet Handle
* Operated By 21 mm Hex Adaptor: 1/2" Sq. X 3/8" Sq.
* All Chrome Plated. 3-Leg Two Way Operated Range: 63 ~102 mm



Strap oil filter wrench

| Part no. | 50/16.6/17.6/3.4' | 330g |
|----------|-------------------|------|
| 61908 | | |

*With non-slip rubber-fabric strap
*Especially suitable for plastic pipes
*Strap length: 420 mm
*Capacity: 110 mm diameter

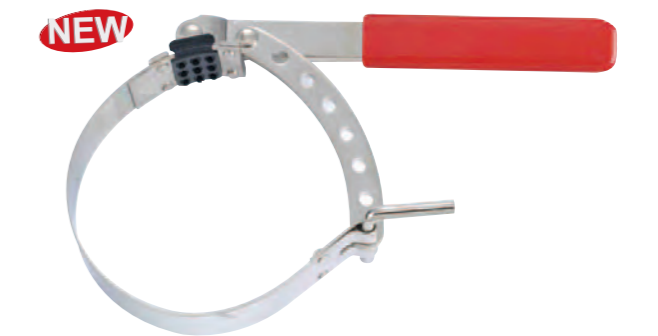

Adjustable oil filter wrench

| Part no. | 50/17.5/18.5/4.83' | 350g |
|----------|--------------------|------|
| 61909 | | |

*Capacity: 80-110 mm diameter

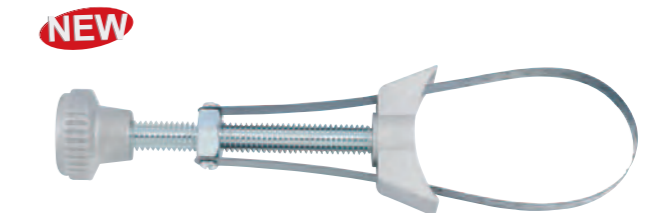

Oil filter wrench

| Part no. | mm | g |
|----------|---------|-----|
| 61910 | 65-110 | 210 |
| 61910L | 110-155 | 230 |

*Spring steel strip
*Aluminium diecast
* Diecast available(61910-D /61910L-D)



Oil filter master pliers

| Part no. | Filter size | packing | l mm | g |
|----------|-------------|-------------------|------|-----|
| 639230 | 53-118mm | 40/18.4/19.4/1.7' | 230 | 460 |



Oil filter pliers

| Part no. | Filter size | packing | inch | g |
|----------|-------------|-------------------|------|-----|
| 639250 | 60-90mm | 60/21.2/22.2/2.1' | 10" | 353 |
| 639300 | 85-115mm | 60/22.7/23.7/2.5' | 12" | 378 |
| 639365 | 100-140mm | 20/17.3/18.3/1.1' | 14" | 865 |



NEW



Iron pipe cutter

| Part no. | l | g |
|----------|------|-------|
| 65605 | 43cm | 3.1kg |

*For 1/2"-2" (12mm-50mm) O.D. iron pipe
*Part: Cutting wheel (65605-B)

NEW



Stainless steel PVC pipe cutter

| Part no. | l | g |
|----------|-------|------|
| 65607 | 225mm | 490g |

*For 42mm O.D. PVC pipe
*Part: Cutting wheel (65607-B)

Telescopic tubing cutter

| Part no. | size | packing | g |
|----------|-------------------------|-------------------|------|
| 65601 | 3-32mm (1/8" to 1-1/4") | 60/17.0/18.0/2.1' | 283g |



Mini tubing cutter

| Part no. | size | packing | g |
|----------|-----------------------|--------------------|------|
| 65602 | 3-22mm (1/8" to 7/8") | 100/14.0/15.0/1.2' | 140g |

Exhaust pipe and tubing cutter

| Part no. | packing | g |
|----------|-------------------|------|
| 65603 | 30/16.7/17.7/1.4' | 556g |

* Cuts thin walled steel and copper tubing from Ø20mm to Ø75mm (3/4"-3").
* Cuts quickly and easily.
* Fitted with 7 cutting blades for fast, clean cutting.



3-IN-1 Tubing bender

| Part no. | Application size | packing | g |
|----------|------------------|-----------------|-----|
| 65301 | 6;8;10mm | 50/19.5/20.5/2' | 390 |
| 65302 | 1/4";5/16";3/8" | 50/19.5/20.5/2' | 390 |

NEW



180° 3-in-1 tube bender

| Part no. | Application size | packing | g |
|----------|-----------------------------|-----------------|-----|
| 653180 | 6;8;10mm 1/4";5/16";3/8" | 20/10.9/11.9/2' | 545 |



Piston ring compressor

| Part no. | Capacity mm | packing | l inch | g |
|----------|-------------|-------------------|--------|-----|
| 6203125 | 53-125 | 50/13.0/14.0/1.3' | 3" | 275 |
| 6203175 | 90-175 | 50/15.0/16.0/1.3' | 3" | 308 |
| 6204125 | 90-125 | 50/17.0/18.0/1.3' | 4" | 316 |
| 6204175 | 90-175 | 50/18.0/19.0/1.3' | 4" | 350 |
| 6206175 | 90-175 | 20/12.0/13.0/1.6' | 6" | 600 |



Piston ring pliers

| Part no. | packing | W mm | l mm | g |
|----------|-------------------|------|------|-----|
| 62301 | 50/15.0/16.0/2.8' | 140 | 3" | 250 |
| 62302 | 50/18.5/19.5/2.4' | 190 | 3" | 370 |

*62302 is applied to truck.



Disc brake adjuster

| Part no. | packing | g |
|----------|-----------------|------|
| 62901 | 20/19.4/20.4/1' | 970g |

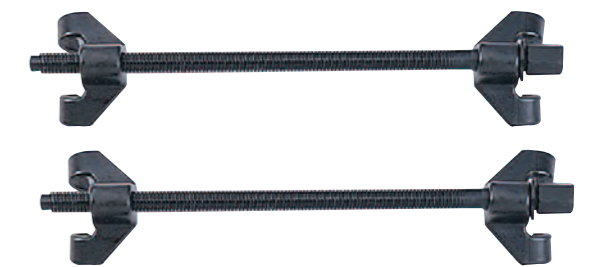

Coil spring compressor

| Part no. | packing | l mm | g |
|----------|-------------------|------|------|
| 627270 | 10/19.0/20.0/1.2' | 270 | 1900 |
| 627370 | 10/20.5/21.5/1.5' | 370 | 2050 |

*Coil spring compressor made by forging and easy to use.
Sold and packed in pair.

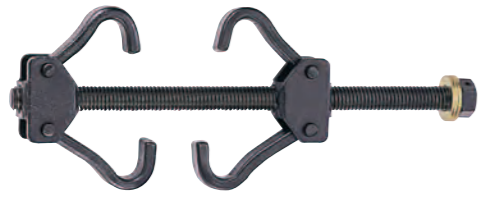

Coil spring compressor

| | | |
|--------------|-------------------|-------|
| 62701 | | |
| Part no. | 12/17.0/18.0/1.3' | 1416g |

- * Use tool to remove and install automotive coil springs up to 5-5/8" OD. designed to grasp a maximum 3/4" wire diameter spring.
- * Compress can be used on straight or curved coil spring.
- * Forged alloy steel.

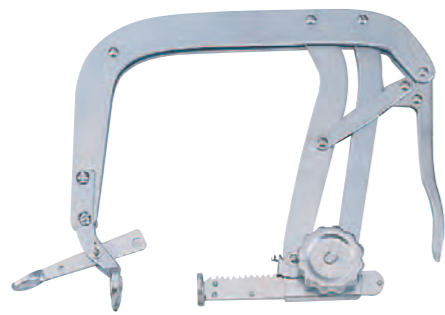

Valve spring compressor

| | | |
|--------------|------------------|-------|
| 62101 | | |
| Part no. | 8/25.0/26.0/1.7' | 3125g |

- * For large engines, most suitable for commercial vehicles and general garage use.



Valve spring compressor

| | | |
|--------------|-------------------|-------|
| 62102 | | |
| Part no. | 10/16.5/17.5/1.2' | 1650g |

- * For overhead cam engines, specially designed for O.H.C. engines.

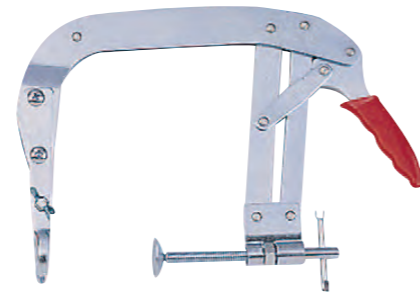

Valve spring compressor

| | | |
|--------------|-------------------|-------|
| 62103 | | |
| Part no. | 10/11.6/12.6/0.5' | 1160g |

- * For small and medium engines.

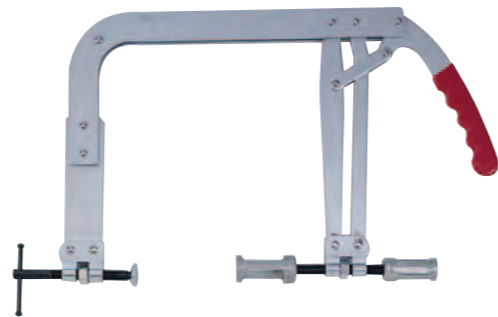

Valve spring compressor

| | | |
|--------------|----------------|-------|
| 62104 | | |
| Part no. | 6/15.0/16.0/1' | 2450g |

- * For multi-valve petrol and diesel engines, specially designed for difficult access and deep-seated multi-valve cylinder heads.



Valve spring compressor

| | | |
|--------------|-------------------|------|
| 62106 | | |
| Part no. | 24/16.8/17.8/2.1' | 660g |

- * Compresses overhead valve springs with rocker arm studs.
- * This tool can be used with the head either on or off the engine.
- * Jaws adjust to fit most overhead valve engines.
- * Adjustable handle allows for clearance in tight areas.

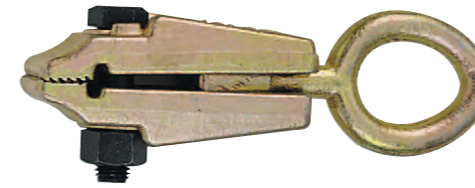

Clamp

| | | | |
|--------------|-------------------|-------|---------|
| 62501 | | | |
| Part no. | 10/21.0/22.0/0.6' | 2100g | 2pc/box |

- * Single direction action.
- * Capacity: 5 tons

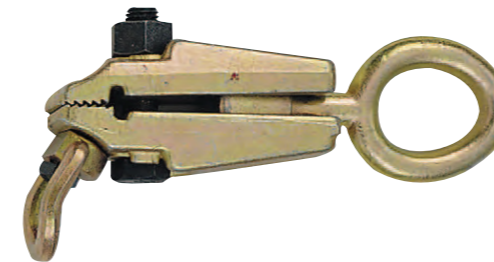

Clamp

| | | | |
|--------------|-------------------|-------|---------|
| 62502 | | | |
| Part no. | 10/21.0/22.0/1.2' | 2100g | 2pc/box |

- * Two direction action.
- * Cross Capacity: 2 tons
- * Longitudinal Capacity: 5 tons

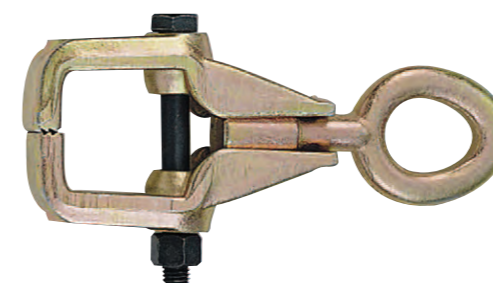

Clamp

| | | | |
|--------------|--------------------|-------|---------|
| 62503 | | | |
| Part no. | 10/19.6/20.6/0.88' | 1960g | 1pc/box |

- * Single direction action,
- * Capacity: 3 tons

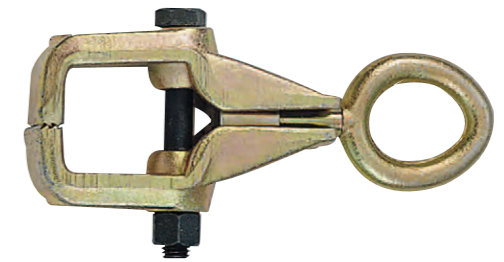

Clamp

| | | | |
|--------------|--------------------|-------|---------|
| 62504 | | | |
| Part no. | 10/18.0/19.0/0.88' | 1800g | 1pc/box |

- * Single direction action.
- * The two side heights of jaw surface are not even, most suitable for narrow space application.
- * Capacity: 3 ton

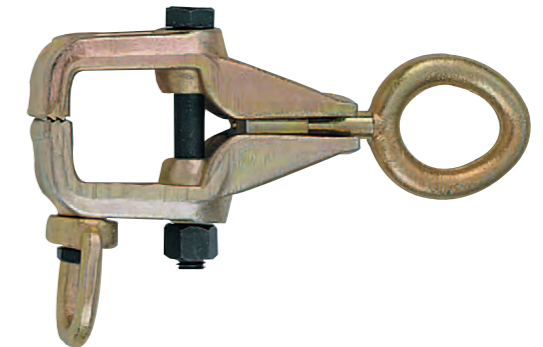

Clamp

| | | | |
|--------------|-------------------|-------|---------|
| 62505 | | | |
| Part no. | 10/19.6/20.6/1.2' | 1960g | 1pc/box |

- * Two direction action.
- * The two side heights of jaw surface are not even, most suitable for narrow space application.
- * Cross Capacity: 2 ton
- * Longitudinal Capacity: 3 ton

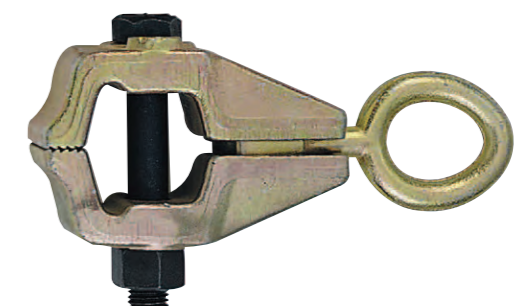

Clamp

| | | | |
|--------------|------------------|-------|---------|
| 62506 | | | |
| Part no. | 6/17.8/18.8/0.7' | 2960g | 1pc/box |

- * Single direction action.
- * Capacity: 5 ton



| Clamp | | |
|--------------|------------------|-------|
| 62507 | | |
| Part no. | 5/15.2/16.2/1.1' | 3500g |

- * Multi-direction action.
- * The jaw surface can be extended about 3" (75mm).
- * Capacity: 4 ton



| Clamp | | |
|--------------|------------------|-------|
| 62508 | | |
| Part no. | 4/19.5/20.5/1.4' | 4750g |

- * Multi-direction action.
- * The jaw surface can be extended about 6" (150mm).
- * Capacity: 4 ton



| Clamp | | |
|--------------|--------------------|-------|
| 62509 | | |
| Part no. | 10/15.8/16.8/0.63' | 1580g |

- * Single direction action.
- * Long jaw mouth is most suitable for narrow space application.
- * Capacity: 1 ton



| Clamp | | | |
|--------------|------------------|-------|---------|
| 62510 | | | |
| Part no. | 6/15.0/16.0/0.7' | 2500g | 1pc/box |

- * Single direction action.
- * No need screw for locking.
- * During operation it will lock as well as tightly.
- * Capacity: 3 ton

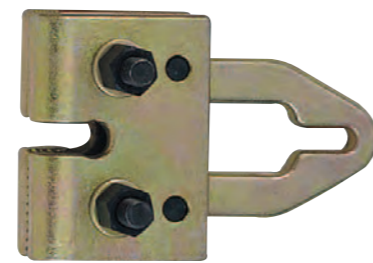

| Clamp | | | |
|--------------|------------------|-------|---------|
| 62511 | | | |
| Part no. | 6/13.9/14.9/0.7' | 2330g | 1pc/box |

- * Single direction action.
- * The jaw surface is long 120mm, most suitable for thin sheet application.
- * Capacity: 5 ton



| Clamp | | | |
|--------------|------------------|-------|---------|
| 62512 | | | |
| Part no. | 6/16.3/17.3/0.7' | 2710g | 1pc/box |

- * Two direction action.
- * The jaw surface is long 120mm, most suitable for thin sheet application.
- * Cross Capacity: 3 ton
- * Longitudinal Capacity: 5 ton



| Clamp | | | |
|--------------|------------------|-------|---------|
| 62513 | | | |
| Part no. | 6/19.6/20.6/0.7' | 3260g | 1pc/box |

- * Universal direction action.
- * The jaw surface is long 120mm, most suitable for thin sheet application.
- * Cross Capacity: 3 ton
- * Longitudinal Capacity: 5 ton
- * Multi-direction Capacity: 3 ton



| Clamp | | | |
|--------------|--------------------|-------|---------|
| 62514 | | | |
| Part no. | 20/23.0/24.0/0.63' | 1150g | 2pc/box |

- * Applying for connecting and shortening the chain. (3/8" and 5/16" chain applicatory)
- * Capacity: 6 ton

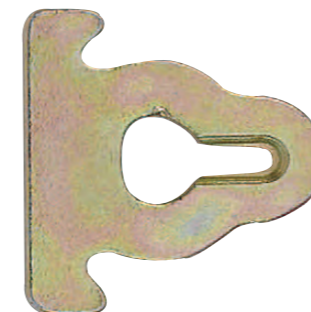

| Clamp | | | |
|--------------|--------------------|-------|---------|
| 62515 | | | |
| Part no. | 10/11.5/12.5/0.32' | 1150g | 2pc/box |

- * Applying for two clamps are connected by a chain and make a two sides action. (3/8" and 5/16" chain applicatory)
- * Capacity: 6 ton

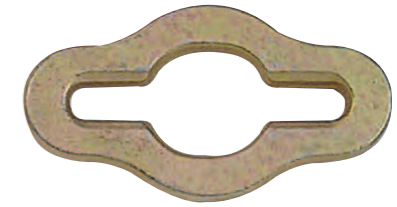

| Clamp | | | |
|--------------|------------------|------|---------|
| 62516 | | | |
| Part no. | 10/6.5/7.5/0.32' | 650g | 2pc/box |

- * Applying for connecting and shortening the chain. (3/8" and 5/16" chain applicatory)
- * Capacity: 6 ton

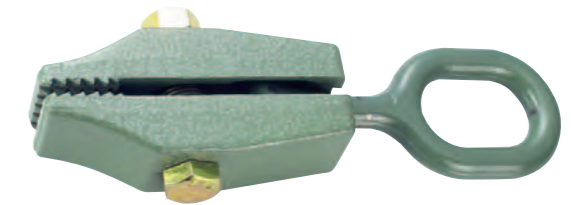

| SELF-TIGHTENING CLAMP | | | |
|-----------------------|--------------------|-------|---------|
| 9M1601 | | | |
| Part no. | 15/16.5/17.5/0.61' | 1100g | 1pc/box |

- * Minimum size, maximum capability for tight places.
- * Responsive, spring-loaded, one-handed application for fast action pulls.
- * Round wedge allows chain to be pulled free of twists.
- * Aggressive cross-hatched tooth design.
- * Capacity: 5 ton

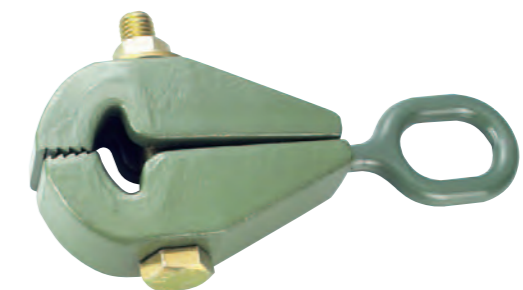

| SELF-TIGHTENING CLAMP | | | |
|-----------------------|-------------------|-------|---------|
| 9M1602 | | | |
| Part no. | 8/18.0/19.0/0.65' | 2250g | 1pc/box |

- * Self-Tightening clamp; grips tighter as it is pulled.
- * Compact and lightweight for pulling from many places.
- * Minimum of 1-1/2" reach-around for flanges, cowls, pinch welds, and lips.
- * Butts against panels where only narrow bite available.
- * 1-1/4"(31.8mm) jaws give added grip.
- * Capacity: 6 ton



SELF-TIGHTENING CLAMP

| | | |
|---------------|-------------------|-------|
| 9M1603 | | |
| Part no. | 8/14.0/15.0/0.65' | 1750g |

- * Self-tightening: The harder it's pulled, the tighter it grips.
- * Heat-treated steel clamp is positioned on work with wedge forward and nut just finger tight.
- * Easy to attach no special wrench needed.
- * 2-1/4" (57.2mm) jaws
- * Capacity: 6 ton



CV Boot clamp pliers

| | | |
|--------------|-------------------|------|
| 62519 | | |
| Part no. | 72/23.0/24.0/2.1' | 320g |

- * A sturdy tool, works on earless-type clamps including those found on GM inboard CV joint.



Ball joint separator

| | | |
|--------------|-------------------|-------|
| 62801 | | |
| Part no. | 20/24.0/25.0/1.3' | 1200g |

- * Jaw open: 19mm



Ball Joint Extractor

| | | |
|--------------|-------------------|-------|
| 62806 | | |
| Part no. | 12/18.2/18.7/0.9' | 1620g |

- * For splitting track-rod ends, anti-roll bar mountings, wheel-hub ball joints, etc.
- * Jaw open: 22mm
- * 2-Stage, 50-80mm.

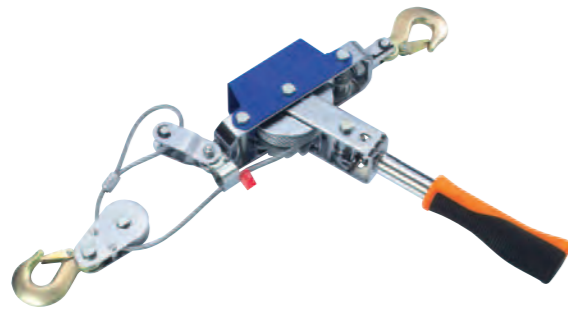

1 ton Portable puller

| | | |
|--------------|------------------|-------|
| 88201 | | |
| Part no. | 6/20.4/21.9/2.0' | 3400g |



CV Joint boot clamp pliers

| | | |
|--------------|-------------------|------|
| 62520 | | |
| Part no. | 48/17.8/18.8/1.5' | 354g |

- * For ear type clamps, fits late model GM CV joint boots, also installs PERMA-QUICK type clamps quickly and easily use for filter, cooling system and vacuum lines.

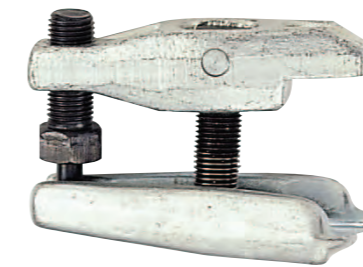

Ball joint separator

| | | |
|--------------|-----------------|-------|
| 62802 | | |
| Part no. | 20/21.0/22.0/1' | 1050g |

- * Jaw open: 20mm



Ball joint Extractor 23mm

| | | |
|----------------|--------------------|------|
| 6280723 | | |
| Part no. | 30/24.8/25.8/0.99' | 826g |

- * For splitting track-rod ends, anti-roll bar mountings, ball joints, etc., especially in small space conditions.
- * Audi VW, BMW, Ford, Mercedes (W170, W202, ETC), Opel/Vauxhall, etc.
- * Jaws open: 23mm
- * Jaws deep: 25mm



Flat band hose clamp pliers

| | | |
|--------------|-------------------|------|
| 62518 | | |
| Part no. | 72/17.3/18.3/2.2' | 240g |

- * Removes and installs new style flat band hose clamps. Jaws rotate to grip at any angle.



CV Dust boot clamp installer with cutter

| | | |
|--------------|-------------------|------|
| 62521 | | |
| Part no. | 36/20.0/21.0/1.8' | 556g |

- * Use 1/2" socket wrench to wind and crimp by hand tool is easily disengaged from the band after the band is tightened.
- * Cut off easily with built in cutting arm without any other tool.



Ball joint separator

| | | |
|--------------|-------------------|-------|
| 62805 | | |
| Part no. | 20/26.2/27.2/1.1' | 1310g |

- * This universal tie rod end remover will work on most cars and light trucks.
- * The necessary force needed to remove tie rod end is easily applied through the center pivot action.
- * Fork opening: 20mm
- * Reach: 20mm-50mm
- * Suitable for: VW-AUDI, BMW, FIAT, FORD, MERCEDES,NISSAN, OPEL, PEUGEOT, RENAULT, ROVER,SAAB, TOYOTA, VOLVO.



Ball joint Extractor 28mm

| | | |
|----------------|--------------------|------|
| 6280728 | | |
| Part no. | 30/24.1/25.1/0.99' | 800g |

* For splitting track-rod ends, anti-roll bar mountings, ball joints, etc., especially in small space conditions.
 * Audi A4, A6, A8, VW Passat and Mercedes W203 etc.
 * Jaws open: 28mm
 Jaws deep: 25mm



Universal ball joint puller

| | | | |
|--------------|----------|-------------------|------|
| 62808 | | | |
| Part no. | Jaw open | Packing | g |
| 6280817 | 17 mm | 17/17.8/18.8/2.1' | 1040 |
| 6280820 | 20 mm | 20/23.3/24.3/2.1' | 1165 |

* Special steel for removing the ball pivots on steering arms, steering tie rocks, steering knuckles etc.



Universal ball joint separator

| | | |
|--------------|------------------|-------|
| 62809 | | |
| Part no. | 10/9.0/10.0/2.1' | 2900g |

* Special steel for removing the ball pivots on steering arms, steering tie rocks, steering knuckles, etc.

NEW



Tie rod end & pitman arm puller for compact cars

| | | |
|--------------|------------------|------|
| 62811 | | |
| Part no. | 20/8.9/9.9/0.46' | 439g |

*For the safe easy removal of pitman arm assembly from compact automobiles.
 *Forged, heat-treated yoke with extra heavy center screw
 *Opening: 1-1/16"(27mm)
 *Pull: 1-3/4"

NEW



Tie rod end & pitman arm puller

| | | |
|--------------|----------------|------|
| 62812 | | |
| Part no. | 24/19/20/0.79' | 855g |

*Redesigned heavy duty tool to be used to remove pitman arms from late model cars and light trucks
 *Yoke is forged from high grade alloy steel and heat-treated.
 *Opening: 1-5/16"
 *Pull: 2-1/2"

NEW



Pitman arm puller

| | | |
|--------------|-------------------|-------|
| 62813 | | |
| Part no. | 20/22.7/23.7/2.0' | 1134g |

*Designed to handle the toughest Pitman arm pulling jobs on passenger cars and light trucks.
 *Features special forged jaws shaped to fit the job.
 *To use, simply remove the retaining nut, place the puller jaws behind the pitman arm and tighten the forcing screw. Mechanical power does the rest.

NEW



Outer tie rod remover

| | | |
|--------------|-------------------|-------|
| 62814 | | |
| Part no. | 20/22.9/23.9/2.0' | 1143g |

*Two adjustable jaws special designed for removing outer tie rods of most models.
 *Works on imports and domestics; front or rear wheel drives and castors stamped steel steering knuckles.



Ball joint extractor

| | | | |
|-------------|------|-------------------|------|
| 628E | | | |
| Part no. | size | packing | g |
| 628E18 | 18mm | 60/19.0/18.0/1.2' | 316 |
| 628E23 | 23mm | 30/16.0/17.0/1.2' | 533 |
| 628E29 | 29mm | 20/17.6/18.6/0.9' | 880 |
| 628E40 | 40mm | 12/18.6/19.6/1' | 1550 |
| 628E46 | 46mm | 12/21/22/1.1' | 1750 |

* For splitting track-rod ends, anti-roll bar mountings, ball joints etc.



Ball joint separator

| | | | | |
|------------|--------|-------------------|-----|------|
| 628 | Open | | | |
| Part no. | Size | Packing | mm | g |
| 628300 | 15/16" | 25/19.0/20.0/0.3' | 300 | 760 |
| 628400 | 21/32" | 20/20.0/21.0/0.3' | 400 | 1000 |

NEW



Fixed type adjustable hook wrench

| | | | |
|------------|---------|--------------------|--------|
| 823 | size | | |
| Part no. | mm | packing | Weight |
| 823035 | 13-35 | 160/18.0/19.0/1.1' | 110g |
| 823050 | 35-50 | 80/17.0/18.0/1' | 210g |
| 823080 | 50-80 | 40/17.0/18.0/0.9' | 425g |
| 823120 | 80-120 | 24/18.0/19.0/1' | 750g |
| 823180 | 120-180 | 12/17.0/18.0/1' | 1.4kg |

*CR-V steel
 *Drop forged body

NEW



Pin type adjustable hook wrench

| | | | |
|-------------|---------|--------------------|--------|
| 823A | size | | |
| Part no. | mm | packing | Weight |
| 823A035 | 13-35 | 160/18.0/19.0/1.1' | 110g |
| 823A050 | 35-50 | 80/17.0/18.0/1' | 210g |
| 823A080 | 50-80 | 40/17.0/18.0/0.9' | 425g |
| 823A120 | 80-120 | 24/18.0/19.0/1' | 750g |
| 823A180 | 120-180 | 12/17.0/18.0/1' | 1.4kg |

*CR-V steel
 *Drop forged body



NEW



Gear puller - 2 Jaw

| Part no. | size | packing | g |
|--------------|------|--------------------|------|
| 65901 | | | |
| 6590103 | 3" | 40/34.9/35.9/0.92' | 872 |
| 6590104 | 4" | 20/16.0/17.0/0.75' | 818 |
| 6590106 | 6" | 10/35.9/36.9/1.2' | 3586 |
| 6590108 | 8" | 5/20.0/21.0/1.2' | 3972 |
| 6590112 | 12" | 3/24.0/25.0/1.6' | 8000 |

Gear puller - 2 Arm

| Part no. | Jaw open | Capacity | kg |
|--------------|----------|----------|-----|
| 65903 | | | |
| 65903065 | 25-65 | 1.5 | 0.4 |
| 65903090 | 30-90 | 3.0 | 0.9 |
| 65903130 | 45-130 | 3.0 | 1.0 |
| 65903160 | 45-160 | 4.0 | 2.8 |
| 65903210 | 45-210 | 4.0 | 3.0 |
| 65903270 | 65-270 | 5.0 | 7.5 |
| 65903340 | 65-340 | 5.0 | 8.2 |

Hydraulic puller

| Part no. | Capacity | Reach(mm) | Spread(mm) | Stroke(mm) | kg |
|----------------|----------|-----------|------------|------------|----|
| 6590630 | | | | | |
| 6590630 | 30 tons | 375-15" | 540 | 110 | 31 |

Hydraulic puller

| Part no. | Capacity | Reach(mm) | Spread(mm) | Stroke(mm) | kg |
|----------------|----------|-----------|------------|------------|----|
| 6590725 | | | | | |
| 6590725 | 25 tons | 300-12" | 406 | 110 | 20 |
| 6590725L | 25 tons | 375-15" | 406 | 110 | 20 |



Gear puller - 3 Jaw

| Part no. | size | packing | g |
|--------------|------|-------------------|------|
| 65902 | | | |
| 6590203 | 3" | 30/17.2/18.2/0.9' | 572 |
| 6590204 | 4" | 20/21.4/22.4/0.8' | 1072 |
| 6590206 | 6" | 8/19.8/20.8/1' | 2480 |
| 6590208 | 8" | 4/21.8/22.8/1.35' | 5456 |
| 6590212 | 12" | 1/11.0/12.0/1' | 11kg |

Hydraulic puller

| Part no. | Capacity | Reach(mm) | Spread(mm) | Stroke(mm) | kg |
|--------------|----------|-----------|------------|------------|-----|
| 65906 | | | | | |
| 6590604 | 4 tons | 152-6" | 150 | 55 | 4.5 |
| 6590606 | 6 tons | 152-6" | 200 | 82 | 4.9 |
| 6590606L | 6 tons | 190-8" | 200 | 82 | 4.9 |
| 6590608 | 8 tons | 190-8" | 250 | 82 | 6.6 |
| 6590608L | 8 tons | 225-10" | 250 | 82 | 6.6 |
| 6590615 | 15 tons | 225-10" | 280 | 82 | 8.0 |
| 6590615L | 15 tons | 300-12" | 280 | 82 | 8.0 |

Hydraulic puller

| Part no. | Capacity | Reach(mm) | Spread(mm) | Stroke(mm) | kg |
|--------------|----------|-----------|------------|------------|-----|
| 65907 | | | | | |
| 6590710 | 10 tons | 182-7" | 280 | 82 | 5.6 |
| 6590710L | 10 tons | 220-9" | 280 | 82 | 5.6 |
| 6590712 | 12 tons | 220-9" | 305 | 82 | 7.6 |
| 6590712L | 12 tons | 260-10" | 305 | 82 | 7.6 |
| 6590720 | 20 tons | 260-10" | 356 | 82 | 10 |
| 6590720L | 20 tons | 300-12" | 356 | 82 | 10 |

Separate hydraulic puller

| Part no. | Capacity | Reach(mm) | Spread(mm) | Stroke(mm) | kg |
|--------------|----------|-----------|------------|------------|----|
| 65908 | | | | | |
| 6590815 | 15 tons | 230-9" | 280 | 82 | 14 |
| 6590815L | 15 tons | 300-12" | 280 | 82 | 14 |

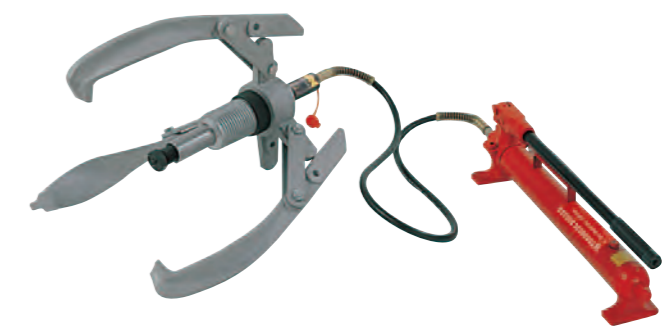

Separate hydraulic puller

| Part no. | Capacity | Reach(mm) | Spread(mm) | Stroke(mm) | kg |
|----------------|----------|-----------|------------|------------|----|
| 6590825 | | | | | |
| 6590825 | 25 tons | 375-15" | 540 | 110 | 30 |



Hydraulic puller with hydraulic pump

| Part no. | Capacity | Reach(mm) | Spread(mm) | Stroke(mm) | kg |
|----------------|----------|-----------|------------|------------|----|
| 6590850 | | | | | |
| 6590850 | 50 tons | 405-16" | 800 | 250 | 45 |
| 6590850L | 50 tons | 635-25" | 1200 | 250 | 49 |



Hydraulic puller

| Part no. | Capacity | Reach(mm) | Spread(mm) | Stroke(mm) | kg |
|--------------|----------|-----------|------------|------------|----|
| 65911 | | | | | |
| 6591106 | 6 tons | 300-12" | 95/235 | 82 | 6 |
| 6591108 | 8 tons | 300-12" | 95/235 | 82 | 7 |
| 6591110 | 10 tons | 330-13" | 95/235 | 82 | 6 |
| 6591112 | 12 tons | 330-13" | 95/235 | 82 | 7 |



Hydraulic puller

| Part no. | Capacity | Reach(mm) | Spread(mm) | Stroke(mm) | kg |
|--------------|----------|-----------|------------|------------|-----|
| 65912 | | | | | |
| 6591206 | 6 tons | 170-7" | 95/210 | 82 | 6.5 |
| 6591208 | 8 tons | 220-9" | 95/220 | 82 | 7.5 |
| 6591210 | 10 tons | 190-8" | 95/210 | 82 | 6.5 |
| 6591212 | 12 tons | 240-10" | 95/220 | 82 | 7.5 |



Hydraulic puller

| Part no. | Capacity | Reach(mm) | Spread(mm) | Stroke(mm) | kg |
|--------------|----------|-----------|------------|------------|-----|
| 65913 | | | | | |
| 6591306 | 6 tons | 170-7" | 95/210 | 82 | 8.5 |
| 6591308 | 8 tons | 220-9" | 95/220 | 82 | 9.5 |
| 6591310 | 10 tons | 190-8" | 95/210 | 82 | 8.5 |
| 6591312 | 12 tons | 240-10" | 95/220 | 82 | 9.5 |



Puller accessory

| Part no. | Capacity | Reach(mm) | Spread(mm) | Stroke(mm) | kg |
|--------------|----------|-----------|------------|------------|-----|
| 659C2 | | | | | |
| 659C206 | 6 tons | 170-7" | 95/210 | 82 | 5.0 |
| 659C208 | 8 tons | 220-9" | 95/220 | 82 | 6.0 |



Puller accessory

| Part no. | Capacity | Reach(mm) | Spread(mm) | Stroke(mm) | kg |
|--------------|----------|-----------|------------|------------|-----|
| 659C3 | | | | | |
| 659C306 | 6 tons | 170-7" | 95/210 | 82 | 8.0 |
| 659C308 | 8 tons | 220-9" | 95/220 | 82 | 9.0 |



Puller accessory and straightener

| Part no. | Reach(mm) | Spread(mm) | Stroke(mm) | kg |
|-------------|-----------|------------|------------|------|
| 659A | | | | |
| 659A01 | 150 | 100/410 | 82 | 9.5 |
| 659A02 | 205 | 100/410 | 82 | 9.0 |
| 659A03 | 205/150 | 100/410 | 82 | 10.0 |

* This puller part converts 6590615 and 6590815 into a hydraulic straightening tool



Gear puller - 2 Jaw

| Part no. | Size | Length | Ton | kg |
|--------------|------|--------|-----|------|
| 65909 | | | | |
| 65909090 | 90 | 100 | 3 | 1.1 |
| 65909130 | 130 | 100 | 3 | 1.3 |
| 65909160 | 160 | 150 | 5 | 3.2 |
| 65909200 | 200 | 150 | 5 | 3.6 |
| 65909250 | 250 | 200 | 7.5 | 7.8 |
| 65909350 | 350 | 200 | 7.5 | 9.2 |
| 65909520 | 520 | 200 | 10 | 15.2 |
| 65909640 | 640 | 225 | 15 | 23.2 |

Quick-adjusting puller - 2 Arm

| Part no. | Jaw open | Reach | Packing | kg |
|---------------|----------|-------|--------------------|-----|
| 65909Q | | | | |
| 65909090Q | 90 | 100 | 12/14.0/15.0/0.57' | 1.2 |
| 65909130Q | 130 | 100 | 12/15.5/16.8/0.57' | 1.3 |
| 65909160Q | 160 | 150 | 6/18.6/19.6/0.56' | 3.1 |
| 65909200Q | 200 | 150 | 6/21.3/22.3/0.63' | 3.6 |
| 65909250Q | 250 | 200 | 3/21.8/22.8/0.62' | 7.3 |

NEW



Gear puller - 3 Arm

| Part no. | Jaw open | Reach | Packing | kg |
|--------------|----------|-------|--------------------|-----|
| 65910 | | | | |
| 65910090 | 90 | 100 | 12/17.8/18.8/0.71' | 1.5 |
| 65910130 | 130 | 100 | 12/19.8/20.8/0.79' | 1.7 |
| 65910160 | 160 | 150 | 3/12.2/13.2/0.46' | 4.1 |
| 65910200 | 200 | 150 | 3/13.2/14.2/0.54' | 4.4 |
| 65910250 | 250 | 200 | 2/18.1/19.1/0.82' | 9.1 |

NEW



Quick-adjusting puller - 3 Arm

| Part no. | Jaw open | Reach | Packing | kg |
|---------------|----------|-------|--------------------|-----|
| 65910Q | | | | |
| 65910090Q | 90 | 100 | 12/18.3/19.3/0.71' | 1.5 |
| 65910130Q | 130 | 100 | 12/20.1/21.1/0.79' | 1.7 |
| 65910160Q | 160 | 150 | 3/12.3/13.3/0.46' | 4.1 |
| 65910200Q | 200 | 150 | 3/13.3/14.3/0.54' | 4.4 |
| 65910250Q | 250 | 200 | 2/17.6/18.6/0.82' | 8.8 |



Bearing puller

| Part no. | Capacity | g | packing |
|----------|-------------|-----|-----------------|
| 666A035 | 19mm - 35mm | 375 | 40/15.0/16.0/1' |
| 666A055 | 24mm - 55mm | 375 | 40/15.0/16.0/1' |
| 666A080 | 35mm - 80mm | 600 | 20/12.0/13.0/1' |



Bearing Separator

| Part no. | Capacity | g |
|----------|--------------------|-------|
| 666050 | 30/17.3/18.3/0.99' | 1730g |

- * 45C, capacity 1-1/4" to 2-1/4" (30-50mm)
- * bolt(Diameter 9.5mm x 125mmL x 3/8" x24t)
- * hole(Diameter 8.2mm x 3/8" x 16t)

Bearing Separator

| Part no. | Capacity | g |
|----------|-------------------|-------|
| 666075 | 12/18.0/19.0/0.7' | 1500g |

- * 45C, capacity 2-1/4" to 3-1/2" (50-75mm)
- * bolt(Diameter 12.7mm x 135mmL x 1/2" x20t)
- * hole(Diameter 8.2mm x 3/8" x 16t)

Bearing Separator

| Part no. | Capacity | g |
|----------|-------------------|-------|
| 666105 | 10/20.0/21.0/0.5' | 2000g |

- * 45C, capacity 3" to 4-1/2" (75-105mm)
- * bolt(Diameter 16mm x 165mmL x 5/8" x 18t)
- * hole(Diameter 11.2mm x 1/2" x 12t)

Bearing Separator

| Part no. | Capacity | g |
|----------|----------------|-------|
| 666150 | 4/30.0/31.0/1' | 5000g |

- * SCM415, capacity 4" to 6" (105-150mm)
- * bolt(Diameter 19mm x 260mmL x 3/4" x 16t)
- * hole(Diameter 14.6mm x 5/8" x 11t)

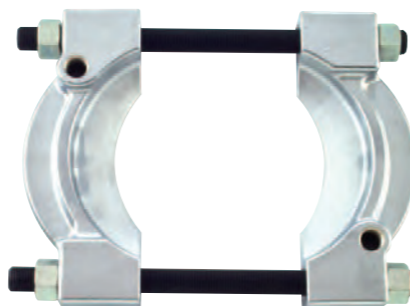

Bearing Separator

| Part no. | Capacity | g |
|----------|------------------|-------|
| 666140 | 6/27.6/28.6/0.6' | 4600g |

- *Capacity 1.5" to 6" (35-140mm)

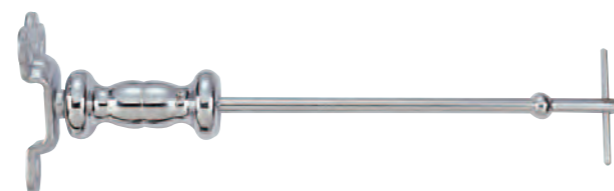

3pc Axle puller

| Part no. | Capacity | g |
|----------|------------------|-------|
| 66402 | 4/16.0/17.0/1.6' | 4000g |

- * Central hole to screw hole 130mm
- * Drop forged



3pc Axle puller

| Part no. | Capacity | g |
|----------|------------------|-------|
| 66404 | 4/17.0/18.0/1.3' | 4250g |

- * Central hole to screw hole 110mm
- * Drop forged



Multi-function powerful suction cup (Aluminum)

| Part no. | Application | packing | Cap kgs | g |
|----------|-------------------|-------------------|---------|------|
| 63401A | On flat object | 20/11.4/12.4/1.5' | 50 | 580 |
| 63403A | Fixed 2 sucker | 10/14.0/15.0/1.4' | 80 | 1400 |
| 63404A | Flexible 2 sucker | 10/14.5/15.5/1.4' | 80 | 1450 |

- * To pull up the plating notched part.
- * To fix the windows while maintaining.
- * To assemble the front and rear wind broken glasses.



Multi-function powerful suction cup

| Part no. | Application | packing | Cap kgs | g |
|----------|-------------------|-----------------|---------|-----|
| 63401 | On flat object | 20/6.5/7.5/1.6' | 50 | 325 |
| 63404 | Flexible 2 sucker | 20/19.5/20.5/4' | 80 | 975 |

- * To pull up the plating notched part.
- * To fix the windows while maintaining.
- * To assemble the front and rear wind broken glasses.



Twist & shrinking hammer

| Part no. | Capacity | g |
|----------|-------------------|------|
| 62601 | 40/17.8/18.8/2.7' | 445g |

- * Twist and shrinking hammer specially designed hammer surface profile has a good performance of expanding and making convex on sheet board.



Cured tooth holder / file holder

| Part no. | Capacity | g |
|----------|-------------------|------|
| 65701 | 20/15.7/16.7/2.1' | 785g |

- Application: for 14" (350mm) flexible file adjustable frame

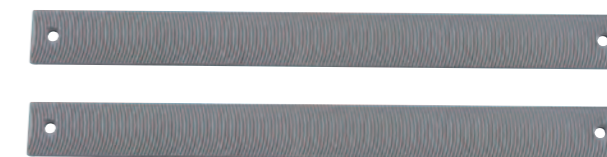

Flexible file blade

| Part no. | teeth per inch | inch | g | pc/box |
|----------|----------------|------|-----|--------|
| 6571409 | 9 | 14" | 310 | 10 |
| 6571412 | 12 | 14" | 350 | 10 |

NEW



Scriber of wolfram steel

| | | |
|--------------|----------|----|
| 87901 | l | |
| Part no. | mm | g |
| 87901 | 145 | 20 |

*Include one tungsten lead and one carbon lead.

NEW



Twist drill set

924U1

- Size: 1.0 - 1.5 - 2.0 - 2.5 - 3.0 - 3.5 - 4.0 - 4.5 - 5.0 - 5.5 - 6.0 - 6.5 - 7.0 - 7.5 - 8.0 - 8.5 - 9.0 - 9.5 - 10.0 - 10.5 - 11.0 - 11.5 - 12.0 - 12.5 - 13.0 mm

- DIN 338 Typ N
- 130° pointed angle
- Titanium coated surface
- High strength hinge
- Right hand cutting
- Relieved cone has a ground point
- Cutting edge has thinning point
- High heat hardness constancy
- High performance steel
- 1.35kg in metal case

NEW



21x28 mm Rectangular deep socket

| | |
|-----------------|--------------------|
| 48311021 | |
| Part no. | 20/28.8/29.8/0.46' |
| | 1440g |

- * Special design for railway.
- * Drive: 1"
- * Size: 21 x 28 mm

NEW



Demagnetizer / Magnetizer

| | | |
|--------------|-------------|--------------------|
| 88601 | | |
| Part no. | Size | packing |
| 88601 | 5cmx5cmx3cm | 120/16.6/17.6/1.3' |
| | | 140 |

NEW



Composite drain key

| | | | |
|---------------|------------------|----------|-----|
| 890220 | | l | |
| Part no. | packing | mm | g |
| 890220 | 20/8.8/9.8/0.62' | 220 | 440 |

Size: 8.7: 9.5: 10.5: 11.5: 13: 6.8: 15.2: 16.5: 19.7 mm

NEW



Air grease gun combination kit

| | | |
|------------|------------------|-----|
| 887 | l | |
| Part no. | Size | mm |
| 88701 | 14 o.z./400 c.c. | 380 |
| 88701L | 16 o.z./500 c.c. | 380 |

- 1pc Air grease gun
- 1pc 1/4" Quick release coupler
- 1pc 1/4" Hose fitting
- 1pc Metallic bend spout
- 1pc 9" High pressure nylon hose
- 1pc Manual operated gun head
- Features:
- * 360° angle-free rotating & continuous flow you.
- * Where there is no air source or air hose can't reach, you can change the air gun head to the hand operated gun head to proceed lubrication by manual operation.

NEW



Lever type grease gun

| | |
|--------------|-------------------|
| 88702 | |
| Part no. | 20/20.9/22.9/1.9' |
| | 1150g |

- * Electric plated finish for long service life
- * Short stroke "lever action" for easy use
- * Uses 150 c.c. bulk grease.

NEW



Lever type grease gun

| | |
|--------------|-------------------|
| 88703 | |
| Part no. | 30/24.1/27.5/1.9' |
| | 890g |

- * Electric plated finish for long service life
- * Short stroke "lever action" for easy use
- * Uses 200 c.c. bulk grease.

NEW



Lever type grease gun

| | |
|--------------|-------------------|
| 88704 | |
| Part no. | 20/23.0/26.9/2.3' |
| | 1.3kg |

- * Electric plated finish for long service life
- * Short stroke "lever action" for easy use
- * Vented head cap for easy filling
- * Used standard 14 oz. Grease cartridge
- * 3 ways loading: Standard 14 oz. Cartridge, pressure filler and bulk 400 c.c.

NEW



Brass & nylon scrape brushes

| | | |
|---------------|-------------|----------------|
| 9U3001 | Size | |
| Part no. | 75mm | 240/8.7/9.7/2' |
| | | 36g |

NEW



Wire brush

| | | |
|---------------|-------------|------------------|
| 9U3003 | Size | |
| Part no. | 220mm | 120/7.7/8.7/2.5' |
| | | 64g |



4pc Star screwdriver set

| | | | |
|----------------|---|------------------|------|
| 2044 | | | |
| Part no. | Tip | 60/9.0/10.0/2.5' | 150g |
| 716185 06...09 | Content: 4-Star screwdriver T6; T7; T8; T9 (blade 100mmL) | | |

4pc Star screwdriver set

| | | | |
|--------------|--|------------------|------|
| 2044S | | | |
| Part no. | Tip | 60/9.0/10.0/2.5' | 150g |
| 716 06...09 | Content: 4-Star screwdriver T6; T7; T8; T9 (blade 60mmL) | | |

4pc Star tamperproof screwdriver set

| | | | |
|---------------|---|------------------|------|
| 2044ST | | | |
| Part no. | Tip | 60/9.0/10.0/2.5' | 150g |
| 717 06...09 | Content: 4-Star tamperproof screwdriver T-6H; T-7H; T-8H; T-9H (blade 60mmL) | | |

NEW



4pc Star screwdriver set

| | | | |
|-------------|--|---------------|------|
| 2048 | | | |
| Part no. | Tip | 60/12/13/2.8' | 200g |
| 716 15...30 | Content: 4-Star screwdriver T15(80mmL); T20(100mmL); T25(100mmL); T30(115mmL) | | |

4pc Star tamperproof screwdriver set

| | | | |
|--------------|--|---------------|------|
| 2048T | | | |
| Part no. | Tip | 60/12/13/2.8' | 200g |
| 717 15...30 | Content: 4-Star tamperproof screwdriver T-15H(80mmL); T-20H(100mmL); T-25H(100mmL); T-30H(115mmL) | | |



6pc Star screwdriver set

| | | | |
|-------------|--|-------------------|------|
| 2061 | | | |
| Part no. | Tip | 30/12.5/13.5/2.2' | 415g |
| 716 10...30 | Content: 6-Star screwdriver T10; T15; T20; T25; T27; T30 | | |

6pc Star tamperproof screwdriver set

| | | | |
|--------------|---|-------------------|------|
| 2061T | | | |
| Part no. | Tip | 30/12.5/13.5/2.2' | 415g |
| 717 10...30 | Content: 6-Star tamperproof screwdriver T-10H; T-15H; T-20H; T-25H; T-27H; T-30H | | |

NEW



6pc Screwdriver set

| | | |
|--------------|---|-------|
| 2068 | | |
| Part no. | 10/10/11/1.2' | 1000g |
| 713 03...065 | Content: 4-Slotted screwdriver 3mm(75mmL); 4mm(100mmL); 5.5mm(125mmL); 6.5mm(150mmL) | |
| 711 1, 2 | 2-Phillips screwdriver PH.1(80mmL); PH.2(100mmL) | |

6pc Hammer screwdriver set

| | | |
|----------------|--|-------|
| 2069 | | |
| Part no. | 10/12.7/13.7/1.2' | 1270g |
| 713 055M...08M | Content: 3-Hammer slotted screwdriver 5.5mm(125mmL); 6.5mm(150mmL); 8mm(150mmL) | |
| 711 1M...3M | 3-Hammer Phillips screwdriver PH.1(80mmL); PH.2(100mmL); PH.3(150mmL) | |

6pc Hammer screwdriver set

| | | |
|----------------|---|-------|
| 20610 | | |
| Part no. | 10/13/14/1.2' | 1300g |
| 713 055M...12M | Content: 4-Hammer slotted Screwdriver 5.5mm(125mmL); 6.5mm(150mmL); 10mm(200mmL); 12mm(200mmL) | |
| 711 2M...3M | 2-Hammer Phillips screwdriver PH.2(100mmL); PH.3(150mmL) | |

NEW



7pc Screwdriver set

| | | |
|--------------|--|-------|
| 20713 | | |
| Part no. | 10/10.1/11.1/1.2' | 1010g |
| 713 04...08 | Content: 4-Slotted screwdriver 4mm(100mmL); 5.5mm(125mmL); 6.5mm(150mmL); 8mm(175mmL) | |
| 711 1...3 | 3-Phillips screwdriver PH.1; PH.2; PH.3 | |

NEW



7pc Hammer screwdriver set

| | | |
|----------------|--|-------|
| 20714 | | |
| Part no. | 10/12.0/13.0/1.2' | 1200g |
| 713 055M...10M | Content: 4-Hammer slotted screwdriver 5.5mm(125mmL); 6.5mm(150mmL); 8mm(150mmL); 10mm(200mmL) | |
| 711 1M...3M | 3-Hammer Phillips screwdriver PH.1; PH.2; PH.3 | |

NEW



7pc Five-sided star tamperproof screwdriver set

| | | | |
|--------------|---|---------------|-------|
| 20717 | | | |
| Part no. | Tip | 10/13/14/1.2' | 1300g |
| 71F 10...40 | Content: 7-Five-sided star tamperproof screwdriver TS10; TS15; TS20; TS25; TS27; TS30; TS40 | | |

NEW



7pc Star screwdriver set (300 mmL)

| | | | |
|----------------|---|-------------------|-------|
| 20719 | | | |
| Part no. | Tip | 10/10.3/11.3/1.3' | 1030g |
| 716300 10...40 | Content: 7-Star screwdriver for hard-to-reach fastener T10; T15; T20; T25; T27; T30; T40 (300mmL) | | |



8pc Screwdriver set

| | | |
|-------------|---|------|
| 2084 | | |
| Part no. | 10/6.8/7.8/1.1' | 680g |
| 71303 | Content: 6-Anti-slip slotted screwdriver 3 mm (75mmL) | |
| 713035 | 3.5 mm (100mmL) | |
| 71304 | 4 mm (100mmL) | |
| 713055 | 5.5 mm (125mmL) | |
| 713065 | 6.5 mm (150mmL) | |
| 71308 | 8 mm (175mmL) | |
| 7111 | 2-Anti-slip Phillips screwdriver PH.1 (80mmL) | |
| 7112 | PH.2 (100mmL) | |



8pc Screwdriver set

| | | |
|-------------|----------------------------------|------|
| 2085 | | |
| Part no. | 10/4.6/5.6/1.1' | 460g |
| 713055S | Content: | |
| 713065S | 2-Anti-slip slotted screwdriver | |
| 7110 | 5.5 mm (25mmL) | |
| 7111S | 6.5 mm (25mmL) | |
| 7120 | 2-Anti-slip Phillips screwdriver | |
| 7121S | PH.0 (60mmL) | |
| 7121 | PH.1 (25mmL) | |
| 7122 | 4-Anti-slip pozidriv screwdriver | |
| | PZ.0 (60mmL) | |
| | PZ.1 (25mmL) | |
| | PZ.1 (80mmL) | |
| | PZ.2 (100mmL) | |



8pc Star screwdriver set

| | | |
|-------------|------------------------------|------|
| 2086 | | |
| Part no. | Tip 10/6.0/7.0/1.1' | 600g |
| 716 08...40 | Content: | |
| | 8-Star screwdriver | |
| | T8; T10; T15; T20; T25; T27; | |
| | T30; T40 | |

8pc Star tamperproof screwdriver set

| | | |
|--------------|--------------------------------|------|
| 2086T | | |
| Part no. | Tip 10/6.0/7.0/1.1' | 600g |
| 717 08...40 | Content: | |
| | 8-Star tamperproof screwdriver | |
| | T-8H; T-10H; T-15H; T-20H; | |
| | T-25H; T-27H; T-30H; T-40H | |

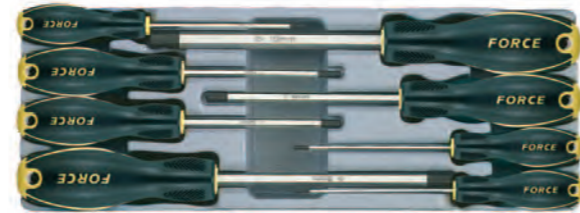

8pc Hex screwdriver set

| | | |
|--------------|------------------------------|------|
| 20810 | | |
| Part no. | Tip 10/8.2/9.2/1.1' | 820g |
| 714 02...10 | Content: | |
| | 8-Hex screwdriver | |
| | 2; 2.5; 3; 4; 5; 6; 8; 10 mm | |



8pc Hex ball screwdriver set

| | | |
|---------------|------------------------------|------|
| 20810B | | |
| Part no. | Tip 10/8.2/9.2/1.1' | 820g |
| 715 02...10 | Content: | |
| | 8-Hex ball screwdriver | |
| | 2; 2.5; 3; 4; 5; 6; 8; 10 mm | |

NEW



9pc Screwdriver set

| | | |
|--------------|-------------------------------|-------|
| 20915 | | |
| Part no. | Tip 10/13/14/1.2' | 1300g |
| 713 03...065 | Content: | |
| 713055S | 4-Slotted screwdriver | |
| 711 1, 2 | 3mm(75mmL); 4mm(100mmL); | |
| 711 1S, 2S | 5.5mm(125mmL); 6.5mm(150mmL) | |
| | 1-Slotted stubby screwdriver | |
| | 5.5mm(25mmL) | |
| | 2-Phillips screwdriver | |
| | PH.1 (80mmL); PH.2 (100mmL) | |
| | 2-Phillips stubby screwdriver | |
| | PH.1 (25mmL); PH.2 (25mmL) | |



10pc Hammer screwdriver set

| | | |
|----------------|-------------------------------|-------|
| 2108 | | |
| Part no. | 6/14.4/15.4/1.3' | 2400g |
| 713 055M...14M | Content: | |
| 711 1M...4M | 6-Hammer slotted screwdriver | |
| | 5.5(125mmL); 6.5(150mmL); | |
| | 8(150mmL); 10(200mmL); | |
| | 12(200mmL); 14(250mmL) | |
| | 4-Hammer Phillips screwdriver | |
| | PH.1(80mmL); PH.2(100mmL); | |
| | PH.3(150mmL); PH.4(200mmL) | |



10pc Hammer screwdriver set

| | | |
|----------------|-------------------------------|-------|
| 2109 | | |
| Part no. | 6/14.4/15.4/1.3' | 2400g |
| 713 055M...14M | Content: | |
| 712 1M...4M | 6-Hammer slotted screwdriver | |
| | 5.5(125mmL); 6.5(150mmL); | |
| | 8(150mmL); 10(200mmL); | |
| | 12(200mmL); 14(250mmL) | |
| | 4-Hammer pozidriv screwdriver | |
| | PZ.1(80mmL); PZ.2(100mmL); | |
| | PZ.3(150mmL); PZ.4(200mmL) | |

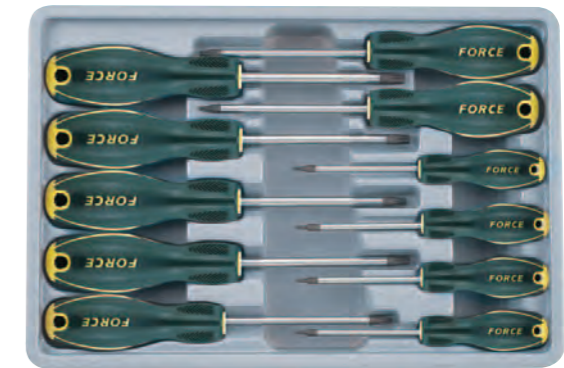

11pc Star screwdriver set

| | | |
|-------------|---------------------------|------|
| 2119 | | |
| Part no. | Tip 20/18.0/19.0/2.3' | 900g |
| 716 06...40 | Content: | |
| | 11-Star screwdriver | |
| | T6; T7; T8; T9; T10; T15; | |
| | T20; T25; T27; T30; T40 | |

11pc Star tamperproof screwdriver set

| | | |
|--------------|---------------------------------|------|
| 2119T | | |
| Part no. | Tip 20/18.0/19.0/2.3' | 900g |
| 717 06...40 | Content: | |
| | 11-Star tamperproof screwdriver | |
| | T-6H; T-7H; T-8H; T-9H; | |
| | T-10H; T-15H; T-20H; T-25H; | |
| | T-27H; T-30H; T-40H | |



13pc Hex nut driver set

| | | |
|----------------|---------------------------------|-------|
| 2134 | | |
| Part no. | Socket 6/11.0/12.0/1.3' | 1833g |
| 744250 04...14 | Content: | |
| | 13-Hex nut driver | |
| | 4; 4.5; 5; 5.5; 6; 7; 8; 9; 10; | |
| | 11; 12; 13; 14 mm(250mmL) | |



13pc Star screwdriver set

| | | | |
|-------------|---|----------------|-------|
| 2137 | | | |
| Part no. | Tip | 6/7.3/8.3/1.3' | 1217g |
| 716 05...45 | Content: 13-Star screwdriver | | |
| | T5; T6; T7; T8; T9; T10; T15; T20; T25; T27; T30; T40; T45 | | |

13pc Star tamperproof screwdriver set

| | | | |
|--------------|--|----------------|-------|
| 2137T | | | |
| Part no. | Tip | 6/7.3/8.3/1.3' | 1217g |
| 717 05...45 | Content: 13-Star tamperproof screwdriver | | |
| | T-5H; T-6H; T-7H; T-8H; T-9H; T-10H; T-15H; T-20H; T-25H; T-27H; T-30H; T-40H; T-45H | | |



14pc Screwdriver set

| | | |
|-----------------|--|-------|
| 2142 | | |
| Part no. | 6/8.4/9.4/1.3' | 1400g |
| 713 03...08 | Content: 6-Slotted screwdriver 3mm(75mmL); 3.5mm(100mmL); 4mm(100mmL); 5.5mm(125mmL); 6.5mm(150mmL); 8mm(175mmL) | |
| 713 055S...065S | 2-Slotted stubby screwdriver 5.5mm(25mmL); 6.5mm(25mmL) | |
| 711 0...3 | 4-Phillips screwdriver PH.0(60mmL); PH.1(80mmL); PH.2(100mmL); PH.3(150mmL) | |
| 711 1S...2S | 2-Phillips stubby screwdriver PH.1(25mmL); PH.2(25mmL) | |



14pc Screwdriver set

| | | |
|-----------------|--|-------|
| 2143 | | |
| Part no. | 6/8.2/9.2/1.3' | 1370g |
| 713 03...08 | Content: 6-Slotted screwdriver 3mm(75mmL); 3.5mm(100mmL); 4mm(100mmL); 5.5mm(125mmL); 6.5mm(150mmL); 8mm(175mmL) | |
| 713 055S...065S | 2-Slotted stubby screwdriver 5.5mm(25mmL); 6.5mm(25mmL) | |
| 712 0...3 | 4-Pozidriv screwdriver PZ.0(60mmL); PZ.1(80mmL); PZ.2(100mmL); PZ.3(150mmL) | |
| 712 1S...2S | 2-Pozidriv stubby screwdriver PZ.1(25mmL); PZ.2(25mmL) | |

NEW



13pc Screwdriver set

| | | |
|--------------|--|-------|
| 21310 | | |
| Part no. | 4/8.2/9.2/1.2' | 2060g |
| 711 0...3 | Content: 4-Phillips screwdriver PH.0(60mmL); PH.1(80mmL); PH.2(100mmL); PH.3(150mmL) | |
| 7112S | 1-Stubby Phillips screwdriver PH.2(25mmL) | |
| 713 03...08 | 5-Slotted screwdriver 3mm(75mmL); 4mm(100mmL); 5.5mm(125mmL); 6.5mm(150mmL); 8mm(175mm L) | |
| 713065S | 1-Stubby slotted screwdriver 6.5mm(25mmL) | |
| 71310M | 1-Hammer slotted screwdriver 10mm(200mmL) | |
| 713055N | 1-Insulated slotted screwdriver 5.5mm(125mmL) | |

NEW



14pc Screwdriver set

| | | |
|--------------|--|-------|
| 21410 | | |
| Part no. | 4/8.8/9.8/1.2' | 2190g |
| 711 0...3 | Content: 4-Phillips screwdriver PH.0(60mmL); PH.1(80mmL); PH.2(100mmL); PH.3(150mmL) | |
| 7112S | 1-Stubby Phillips screwdriver PH.2(25mmL) | |
| 713 03...08 | 5-Slotted screwdriver 3mm(75mmL); 4mm(100mmL); 5.5mm(125mmL); 6.5mm(150mmL); 8mm(175mmL) | |
| 713065S | 1-Stubby slotted screwdriver 6.5mm(25mmL) | |
| 71310M | 1-Hammer slotted screwdriver 10mm(200mmL) | |
| 713055N | 1-Insulated slotted screwdriver 5.5mm(125mmL) | |
| 88601 | 1-Demagnetizer/Magnetizer | |

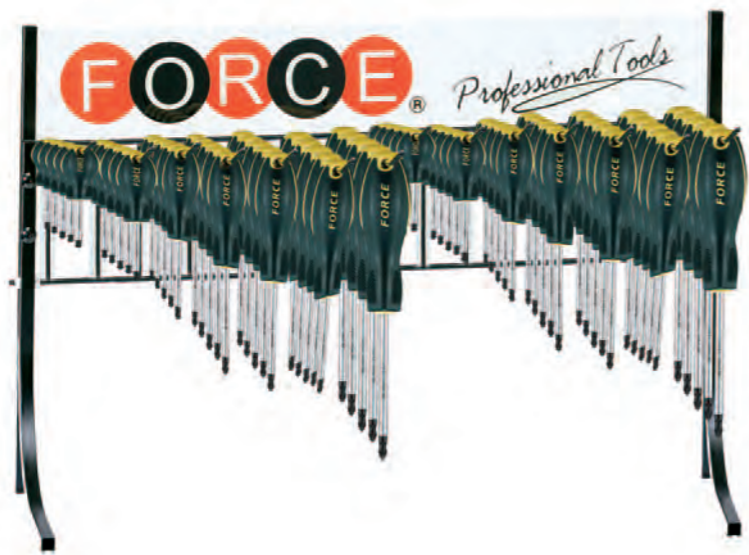

75pc Screwdriver set

| | | |
|---------------------|---|-------|
| 2751 | | |
| Part no. | 2/16.4/17.4/1.4' | 8200g |
| 711 0...3 | Content: 3- Phillips screwdriver PH.0(60mmL); PH.1(80mmL); PH.3(150mmL) | |
| 711 1S...2S | 2- Stubby Phillips screwdriver PH.1(25mmL); PH.2(25mmL) | |
| 713 03...08 | 6- Slotted screwdriver 3mm(75mmL); 3.5mm(100mmL); 4mm(100mmL); 5.5mm(125mmL); 6.5mm(150mmL); 8mm(175mmL) | |
| 713 055S... 065S | 2- Stubby slotted screwdriver 5.5mm(25mmL); 6.5mm(25mmL) | |
| 7112 | * Above each size 5pcs 10- Phillips screwdriver PH.2(100mmL) | |

75pc Screwdriver set

| | | |
|---------------------|---|-------|
| 2752 | | |
| Part no. | 2/16.4/17.4/1.4' | 8200g |
| 712 0...3 | Content: 3- Pozidriv screwdriver PZ.0(60mmL); PZ.1(80mmL); PZ.3(150mmL) | |
| 712 1S...2S | 2- Stubby pozidriv screwdriver PZ.1(25mmL); PZ.2(25mmL) | |
| 713 03...08 | 6- Slotted screwdriver 3mm(75mmL); 3.5mm(100mmL); 4mm(100mmL); 5.5mm(125mmL); 6.5mm(150mmL); 8mm(175mmL) | |
| 713 055S... 065S | 2- Stubby slotted screwdriver 5.5mm(25mmL); 6.5mm(25mmL) | |
| 7122 | * Above each size 5pcs 10- Pozidriv screwdriver PZ.2(100mmL) | |

75pc Star screwdriver set

| | | | |
|-------------|--|------------------|-------|
| 2753 | | | |
| Part no. | Tip | 2/16.4/17.4/1.4' | 8200g |
| 716 05...45 | Content: 11-Star screwdriver T5; T6; T7; T8; T9; T20; T25; T27; T30; T40; T45 | | |
| 716 10...15 | * Above each size 5pcs 2-Star screwdriver T10; T15 | | |
| | * Above each size 10pcs | | |

75pc Star tamperproof screwdriver set

| | | | |
|--------------|---|------------------|-------|
| 2753T | | | |
| Part no. | Tip | 2/16.4/17.4/1.4' | 8200g |
| 717 05...45 | Content: 11-Star tamperproof screwdriver T-5H; T-6H; T-7H; T-8H; T-9H; T-20H; T-25H; T-27H; T-30H; T-40H; T-45H | | |
| 717 10...15 | * Above each size 5pcs 2-Star tamperproof screwdriver T-10H; T-15H | | |
| | * Above each size 10pcs | | |



7pc Insulated screwdriver set

| | | |
|----------------|--|------|
| 20712 | | |
| Part no. | 10/6.4/7.4/1.1' | 640g |
| 711 1N...2N | Content: 2-Insulated Phillips screwdriver PH.1 (80mmL); PH.2 (100mmL) | |
| 713 03N...065N | 4-Insulated slotted screwdriver 3 (100mmL); 4 (100mmL); 5.5 (125mmL); 6.5 (150mmL) | |
| 2125P1 | 1-Induction circuit tester | |

7pc Insulated screwdriver set

| | | |
|-----------------|---|------|
| 20718 | | |
| Part no. | 10/6.8/7.8/1.1' | 675g |
| 711 1N...2N | Content: 2-Insulated Phillips screwdriver PH.1(80mmL); PH.2(100mmL) | |
| 713 024N...065N | 4-Insulated slotted screwdriver 2.5(75mmL); 3.5(100mmL); 5.5(125mmL); 6.5(150mmL) | |
| 88401 | 1-Screwdriver probe voltage tester Testing range:110~250V AC | |

NEW

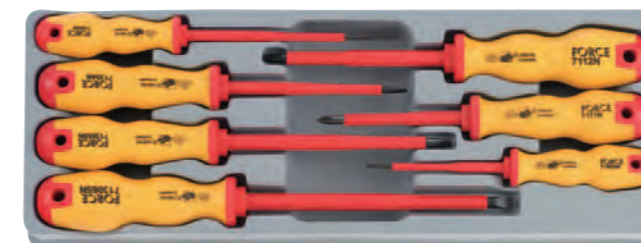

7pc Insulated screwdriver set

| | | |
|-----------------|--|------|
| 20715 | | |
| Part no. | 10/4.8/5.8/1.1' | 480g |
| 713 024N...065N | Content: 5-Insulated slotted screwdriver 2.5mm(75mmL); 3mm(100mmL); 4mm(100mmL);5.5mm(125mmL); 6.5mm(150mmL) | |
| 711 1N...2N | 2-Insulated Phillips screwdriver PH.1; PH.2 | |

NEW



7pc Insulated screwdriver set

| | | |
|-----------------|---|------|
| 20718-3 | | |
| Part no. | 10/6.8/7.8/1.1' | 683g |
| 711 1N...2N | Content: 2-Insulated Phillips screwdriver PH.1(80mmL); PH.2(100mmL) | |
| 713 024N...065N | 4-Insulated slotted screwdriver 2.5(75mmL); 3.5(100mmL); 5.5(125mmL); 6.5(150mmL) | |
| 88403 | 1-Screwdriver probe voltage tester Testing range: 110~250V AC | |



NEW



9pc Insulated screwdriver set

| | | |
|-----------------|---|-------|
| 20916 | | |
| Part no. | 10/14/15/1.2' | 1400g |
| 713 024N...065N | Content: 6-Insulated slotted Screwdrivers 2.4mm(75mmL); 3mm(100mmL); 3.5mm(100mmL); 4mm(100mmL); 5.5mm(125mmL); 6.5mm(150mmL) | |
| 711 1N, 2N | 2-Insulated Phillips screwdrivers PH.1(80mmL) ; PH.2(100mmL) | |
| 88401 | 1-Screwdriver probe voltage tester Testing range:110~250V AC | |



12pc Insulated screwdriver set

| | | |
|---------------|--|-------|
| 2125 | | |
| Part no. | 6/7.0/8.0/1.3' | 1160g |
| 713 024N...8N | Content: 7-Insulated slotted screwdriver 2.5(75mmL); 3(100mmL); 3.5(100mmL); 4(100mmL); 5.5(125mmL); 6.5(150mmL); 8(175mmL) | |
| 711 0N...3N | 4-Insulated Phillips screwdriver PH.0(60mmL); PH.1(80mmL); PH.2(100mmL); PH.3(150mmL) | |
| 2125P1 | 1-Induction circuit tester | |



12pc Insulated screwdriver set

| | | |
|---------------|--|-------|
| 2126 | | |
| Part no. | 6/7.0/8.0/1.3' | 1160g |
| 713 024N...8N | Content: 7-Insulated slotted screwdriver 2.5(75mmL); 3(100mmL); 3.5(100mmL); 4(100mmL); 5.5(125mmL); 6.5(150mmL); 8(175mmL) | |
| 712 0N...3N | 4-Insulated pozidriv screwdriver PZ.0(60mmL); PZ.1(80mmL); PZ.2(100mmL); PZ.3(150mmL) | |
| 2125P1 | 1-Induction circuit tester | |

NEW



5pc Hex screwdriver T handle set

| | | |
|-------------|--|------|
| 2057 | | |
| Part no. | Tip 10/6.5/7.5/1' | 650g |
| 724 03...08 | Content: 5-Hex screwdriver T handle 3; 4; 5; 6; 8 mm | |



NEW



5pc Star screwdriver T handle set

| | | |
|-------------|--|------|
| 2058 | | |
| Part no. | Tip 10/6.5/7.5/1' | 650g |
| 726 10...30 | Content: 5-Star screwdriver T handle T10; T15; T20; T25; T30 | |



9pc Hex screwdriver T handle set(MM)

| | | |
|-------------|--|-------|
| 2097 | | |
| Part no. | Tip 6/7.0/8.0/1.3' | 1166g |
| 724 02...10 | Content: 9-Hex screwdriver T handle 2; 2.5; 3; 4; 5; 6; 7; 8; 10mm | |

9pc Hex screwdriver T handle set(SAE)

| | | |
|----------------|---|-------|
| 2097S | | |
| Part no. | Tip 6/7.0/8.0/1.3' | 1166g |
| 724 3.32...3.8 | Content: 9-Hex screwdriver T handle 3/32"; 7/64"; 1/8"; 5/32"; 3/16"; 7/32"; 1/4"; 5/16"; 3/8" | |

9pc Hex ball point screwdriver T handle set

| | | |
|--------------|--|-------|
| 2097B | | |
| Part no. | Tip 6/7.0/8.0/1.3' | 1166g |
| 725 02...10 | Content: 9-Hex ball point screwdriver T handle 2; 2.5; 3; 4; 5; 6; 7; 8; 10 mm | |



14pc Star screwdriver T handle set

| | | |
|-------------|---|-------|
| 2141 | | |
| Part no. | Tip 6/8.5/9.5/2.4' | 1415g |
| 726 06...55 | Content: 14-Star screwdriver T handle T6; T7; T8; T9; T10; T15; T20; T25; T27; T30; T40; T45; T50; T55 | |

14pc Star tamperproof screwdriver T handle set

| | | |
|--------------|---|-------|
| 2141T | | |
| Part no. | Tip 6/8.5/9.5/2.4' | 1415g |
| 727 06...55 | Content: 14-Star tamperproof screwdriver T handle T-6H; T-7H; T-8H; T-9H; T-10H; T-15H; T-20H; T-25H; T-27H; T-30H; T-40H; T-45H; T-50H; T-55H | |



6pc Jeweler nut driver set

| | | | |
|---------------------------|------------------------------|-------------------|------|
| 2064 | | | |
| Part no. | Socket | 40/14.0/15.0/1.4' | 350g |
| Content: | | | |
| 6-Hex jeweler nut drivers | | | |
| 739 032...055 | 3.2; 4.0; 5.0; 5.5 mm(75mmL) | | |
| 739 1.8...3.16 | 1/8"; 3/16"(75mmL) | | |



6pc Hex jeweler screwdriver set

| | | | |
|---------------------------|--------------------------|-------------------|------|
| 2066 | | | |
| Part no. | Tip | 40/12.0/13.0/1.4' | 300g |
| Content: | | | |
| 6-Hex jeweler screwdriver | | | |
| 734040 009...015 | 0.9; 1.3; 1.5 mm (40mmL) | | |
| 734075 02...03 | 2.0; 2.5; 3.0 mm (75mmL) | | |



6pc Hex jeweler screwdriver set

| | | | |
|---------------------------|---------------------|-------------------|------|
| 2065 | | | |
| Part no. | Tip | 40/12.0/13.0/1.4' | 300g |
| Content: | | | |
| 6-Hex jeweler screwdriver | | | |
| 734040015 | 1.5 mm (40mmL) | | |
| 734075 02...025 | 2.0; 2.5 mm (75mmL) | | |
| 7340400.05 | 0.05" (40mmL) | | |
| 7340401.16 | 1/16" (40mmL) | | |
| 7340753.32 | 3/32" (75mmL) | | |



8pc Jeweler screwdriver set

| | | |
|--------------------------------|---------------------------------|------|
| 2087 | | |
| Part no. | 40/13.6/14.6/1.6' | 340g |
| Content: | | |
| 5-Slotted jeweler screwdriver | | |
| 733075 02...04 | 2.0; 2.5; 3.0; 3.5; 4.0 (75mmL) | |
| 3-Phillips jeweler screwdriver | | |
| 731075 00...1 | PH.00; PH.0; PH.1 (75mmL) | |



8pc Star jeweler screwdriver set

| | | | |
|----------------------------|-----------------------------|-------------------|------|
| 2088 | | | |
| Part no. | Tip | 40/13.6/14.6/1.6' | 340g |
| Content: | | | |
| 8-Star jeweler screwdriver | | | |
| 736040 05...08 | T5; T6; T7; T8 mm(40mmL) | | |
| 736075 09...20 | T9; T10; T15; T20 mm(75mmL) | | |

8pc Star jeweler tamperproof screwdriver set

| | | | |
|--|-----------------------------------|-------------------|------|
| 2088T | | | |
| Part no. | Tip | 40/13.6/14.6/1.6' | 340g |
| Content: | | | |
| 8-Star jeweler tamperproof screwdriver | | | |
| 737040 05...08 | T-5H; T-6H; T-7H; T-8H (40mmL) | | |
| 737075 09...20 | T-9H; T-10H; T-15H; T-20H (75mmL) | | |



10pc Jeweler screwdriver set

| | | |
|--------------------------------|-----------------------------------|------|
| 2106 | | |
| Part no. | 20/14.0/15.0/1.8' | 700g |
| Content: | | |
| 5-Slotted jeweler screwdriver | | |
| 733040 012...024 | 1.2; 1.5; 1.8; 2.0; 2.5mm (40mmL) | |
| 3-Phillips jeweler screwdriver | | |
| 731040 000...0 | PH.000; PH.00; PH.0(40mmL) | |
| 610110 | 1-Snipe nose pliers | |
| 612140 | 1-Stocky model versatility | |
| 2161-1 | 1-Tweezers | |



16pc Jeweler screwdriver set

| | | |
|--------------------------------|--|------|
| 2161 | | |
| Part no. | 20/14.5/15.5/1.8' | 725g |
| Content: | | |
| 6-Slotted jeweler screwdriver | | |
| 733040 01...024 | 1.0; 1.2; 1.5; 1.8; 2.0; 2.5 mm(40mmL) | |
| 2-Phillips jeweler screwdriver | | |
| 731040 000...00 | PH.000; PH.00(40mmL) | |
| 3-Hex jeweler screwdriver | | |
| 734040 009...015 | 0.9; 1.3; 1.5 mm(40mmL) | |
| 610110 | 1-Snipe nose pliers | |
| 612140 | 1-Stocky model versatility | |
| 2161-1 | 1-Tweezer | |
| 2161-2 | 1-Scissors | |
| 2161-3 | 1-Scalpel(with 6 blades) | |

NEW

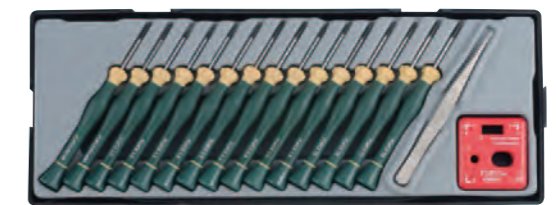

Jeweler screwdriver & (de-)magnetizer set

| | | |
|--------------------------------|--|------|
| T2173 | | |
| Part no. | 6/3.4/4.4/0.73' | 590g |
| Content: | | |
| 2-Phillips jeweler screwdriver | | |
| 731040 000...00 | PH.000; PH.00 (40mmL) | |
| 6-Slotted jeweler screwdriver | | |
| 733040 01...024 | 1.0; 1.2; 1.5; 1.8; 2.0; 2.4 mm(40mmL) | |
| 3-Hex jeweler screwdriver | | |
| 734040 009...015 | 0.9; 1.3; 1.5 mm(40mmL) | |
| 4-Star jeweler screwdriver | | |
| 736040 05...08 | T5; T6; T7; T8 (40mmL) | |
| 2161-1 | 1-Tweezer | |
| 88601 | 1-Demagnetizer/Magnetizer | |



20pc Jeweler screwdriver set

| | | |
|-----------------|---|------|
| 2204 | | |
| Part no. | 40/11.8/12.8/1.5' | 295g |
| Content: | | |
| 73904DS | 1-4mm inhex screwdriver(50mmL) | |
| 11128 00...0 | 2-4mm Phillips bit(28mmL) PH.00; PH.0 | |
| 11228 00...0 | 2-4mm pozidriv bit(28mmL) PZ.00; PZ.0 | |
| 11328 02...04 | 4-4mm slotted bit(28mmL) 2.0; 2.5; 3.0; 4.0 mm | |
| 11428 015...025 | 3-4mm hex bit(28mmL) 1.5; 2.0; 2.5 mm | |
| 11528 015...025 | 3-4mm hex ball bit(28mmL) 1.5; 2.0; 2.5 mm | |
| 11628 06...10 | 5-4mm star bit(28mmL) T6; T7; T8; T9; T10 | |



26pc Jeweler screwdriver set

| | | |
|-----------------|---|------|
| 2261 | | |
| Part no. | 40/13.4/14.4/1.5' | 335g |
| Content: | | |
| 73904DS | 1-4mm inhex screwdriver(50mmL) | |
| 11128 00...0 | 2-4mm Phillips bit(28mmL) PH.00; PH.0 | |
| 11228 00...0 | 2-4mm pozidriv bit (28mmL) PZ.00; PZ.0 | |
| 11328 02...04 | 4-4mm slotted bit(28mmL) 2.0; 2.5; 3.0; 4.0 mm | |
| 11428 015...025 | 3-4mm hex bit(28mmL) 1.5; 2.0; 2.5 mm | |
| 11528 015...025 | 3-4mm hex ball bit(28mmL) 1.5; 2.0; 2.5 mm | |
| 11628 06...10 | 5-4mm star bit(28mmL) T6; T7; T8; T9; T10 | |
| 52422 032...07 | 5- 1/4" socket(22mmL) 3.2; 4.0; 5.0; 5.5; 7.0 mm | |
| 8091225 | 1-Bit adaptor(25mmL) 4mmHex-1/4" Sq. | |



6pc Flare nut wrench set (MM)

| | | |
|-----------------|---|------|
| 5066 | | |
| Part no. | 30/20.5/21.5/1.3' | 610g |
| Content: | | |
| 751 0810...1719 | 6-Flare nut wrench 8x10; 10x11; 10x12; 11x13; 12x14; 17x19 mm | |

6pc Flare nut wrench set (SAE)

| | | |
|-----------------------|--|------|
| 5066S | | |
| Part no. | 30/18.3/19.3/1.5' | 610g |
| Content: | | |
| 751 0810S... 1719S | 6-Flare nut wrench 5/16"x3/8"; 3/8"x7/16"; 7/16"x1/2"; 1/2"x9/16"; 5/8"x3/4"; 11/16"x3/4" | |



8pc Flare nut wrench set

| | | |
|-----------------|---|-------|
| 5082 | | |
| Part no. | 6/14.5/15.5/0.9' | 2415g |
| Content: | | |
| 751 0810...3032 | 8-Flare nut wrench 8x10; 11x13; 12x14; 16x18; 17x19; 19x22; 24x27; 30x32 mm | |



7pc Flare nut wrench set (SAE)

| | | |
|-----------------------|--|-------|
| 50710S | | |
| Part no. | 6/10.0/11.0/0.9' | 1670g |
| Content: | | |
| 751 0810S... 1922S | 7-Flare nut wrench 5/16"x3/8"; 3/8"x7/16"; 7/16"x1/2"; 1/2"x9/16"; 5/8"x3/4"; 11/16"x3/4"; 3/4"x7/8" | |



13pc Crowfoot flare nut wrench set (SAE)

| | | |
|------------------|---|-------|
| 5135S | | |
| Part no. | 6/12.0/13.0/0.9' | 2000g |
| Content: | | |
| 7513 3.8...7.8 | 9-3/8"DR. 12pt. Crowfoot flare nut 3/8"; 7/16"; 1/2"; 9/16"; 5/8"; 11/16"; 3/4"; 13/16"; 7/8" | |
| 7514 15.16...1.0 | 2-1/2"DR. 12pt. Crowfoot flare nut 15/16"; 1" | |
| 808306 | 2-Locking extension 3/8"DR.(150mmL) | |
| 808405 | 1/2"DR.(125mmL) | |



17pc Crowfoot flare nut wrench set (MM)

| | | |
|--------------|---|-------|
| 5172 | | |
| Part no. | 6/12.9/13.9/0.9' | 2150g |
| 7513 10...22 | Content: 12-3/8"DR. 12pt. Crowfoot flare nut 10; 11; 12; 13; 14; 15; 16; 17; 18; 19; 21; 22 mm | |
| 7514 23...26 | 3-1/2"DR. 12pt. Crowfoot flare nut 23; 24; 26 mm | |
| 808306 | 2-Locking extension 3/8"DR.(150mmL) | |
| 808405 | 1/2"DR.(125mmL) | |



11pc 3/8" DR. Crowfoot flare nut wrench

| | | |
|---------------|--|------|
| 51110 | | |
| Part no. | 30/22.0/23.0/1.3' | 730g |
| 751 310...319 | Content:3/8"DR. 10-Crowfoot flare nut wrench 10; 11; 12; 13; 14; 15; 16; 17; 18; 19mm | |
| 808306 | 1-Locking extension 6" | |



3pc Hinged socket wrench set

| | | | |
|-----------------|--|------------------|-------|
| 5033 | | | |
| Part no. | Socket | 6/15.0/16.0/0.9' | 2500g |
| 752 2022...2427 | Content: 3-Hinged socket wrench 20x22; 21x23; 24x27 mm | | |



6pc Hinged socket wrench set (SAE)

| | | | |
|-----------------------|--|------------------|-------|
| 50616S | | | |
| Part no. | Socket | 6/19.0/20.0/0.9' | 3170g |
| 752 1011S... 2425S | Content: 6-Hinged socket wrench 3/8"x7/16"; 1/2"x9/16"; 5/8"x11/16"; 3/4"x7/8"; 13/16"x7/8"; 15/16"x1" | | |



7pc Hinged socket wrench set

| | | | |
|---------------------|---|------------------|-------|
| 5074 | | | |
| Part no. | Socket | 6/13.0/14.0/0.9' | 2165g |
| 752 0607... 1819 | Content: 7-Hinged socket wrench 6x7; 8x9; 10x11; 12x13; 14x15; 16x17; 18x19 mm | | |

NEW



17pc 6pt.-6pt. Angle wrench set

| | | | |
|-------------|--|--------------|-----|
| 5176 | | | |
| Part no. | Socket | 3/21/22/1.5' | 7kg |
| 753 08...24 | Content: 17-6pt.-6pt. Angle wrench 8.9.10.11.12.13.14.15.16 .17. 18.19.20.21.22.23.24mm | | |



6pc Double open end wrench set (MM)

| | | |
|-----------------|--|------|
| 5067 | | |
| Part no. | 20/14.5/15.5/0.8' | 725g |
| 754 0809...2123 | Content: 6-Double open end wrench 8x9; 10x12; 12x14; 14x17; 17x19; 21x23 mm | |

6pc Double open end wrench set (SAE)

| | | |
|-----------------------|---|------|
| 5067S | | |
| Part no. | 20/14.5/15.5/0.8' | 725g |
| 754 0810S... 2122S | Content: 6-Double open end wrench 5/16"x3/8"; 3/8"x7/16"; 1/2"x9/16"; 5/8"x11/16"; 11/16"x3/4"; 13/16"x7/8" | |



8pc Double open end wrench set

| | | |
|---------------------|--|------|
| 5084 | | |
| Part no. | 10/9.6/10.6/0.88' | 960g |
| 754 0607... 2022 | Content: 8-Double open end wrench 6x7; 8x9; 10x11; 12x13; 14x15; 16x17; 18x19; 20x22 mm | |



10pc Double open end wrench set (MM)

| | | |
|-----------------|--|-------|
| 5103 | | |
| Part no. | 10/21.0/22.0/1.6' | 2100g |
| 754 0607...3032 | Content: 10-Double open end wrench 6x7; 8x9; 10x11; 12x13; 14x15; 16x17; 18x19; 20x22; 24x27; 30x32 mm | |

10pc Double open end wrench set (SAE)

| | | |
|-----------------------|---|-------|
| 5103S | | |
| Part no. | 10/21.0/22.0/1.6' | 2100g |
| 754 0608S... 2932S | Content: 10-Double open end wrench 1/4"x5/16"; 5/16"x3/8"; 3/8"x7/16"; 1/2"x9/16"; 9/16"x5/8"; 11/16"x3/4"; 13/16"x7/8"; 15/16"x1"; 15/16"x1-1/16"; 1-1/8"x1-1/4" | |



11pc Double open end wrench set (MM)

| | | |
|-----------------|---|-------|
| 5111 | | |
| Part no. | 6/12.6/13.6/0.8' | 2100g |
| 754 0607...3032 | Content: 11-Double open end wrench 6x7; 8x9; 10x11; 12x13; 14x15; 16x17; 18x19; 20x22; 21x23; 24x27; 30x32 mm | |

11pc Double open end wrench set (SAE)

| | | |
|-----------------------|---|-------|
| 5111S | | |
| Part no. | 6/12.6/13.6/0.8' | 2100g |
| 754 0608S... 2932S | Content: 11-Double open end wrench 1/4"x5/16"; 5/16"x3/8"; 3/8"x7/16"; 1/2"x9/16"; 9/16"x5/8"; 5/8"x11/16"; 11/16"x3/4"; 13/16"x7/8"; 15/16"x1"; 15/16"x1-1/16"; 1-1/8"x1-1/4" | |



11pc Double open end wrench set (MM)

| | | |
|-----------------|---|-------|
| 5112 | | |
| Part no. | 10/19.4/20.4/1.2' | 1940g |
| 754 0607...2427 | Content: 11-Double open end wrench 6x7; 8x9; 10x11; 12x13; 14x15; 16x17; 18x19; 20x22; 21x23; 23x26; 24x27 mm | |

11pc Double open end wrench set (SAE)

| | | |
|----------------------|---|-------|
| 5112S | | |
| Part no. | 10/20.0/21.0/1.2' | 2000g |
| 7540608S... 2932S | Content: 11-Double open end wrench 1/4"x5/16"; 5/16"x3/8"; 3/8"x7/16"; 1/2"x9/16"; 9/16"x5/8"; 5/8"x11/16"; 11/16"x3/4"; 13/16"x7/8"; 15/16"x1-1/16"; 1"x1-1/8"; 1-1/8"x1-1/4" | |



6pc Combination wrench set (MM)

| | | |
|-------------|---|------|
| 5068 | | |
| Part no. | 20/15.2/16.2/0.8' | 760g |
| 755 10...21 | Content: 6-Combination wrench 10; 12; 14; 17; 19; 21 mm | |

6pc Combination wrench set (SAE)

| | | |
|-----------------|--|------|
| 5068S | | |
| Part no. | 20/15.2/16.2/0.8' | 760g |
| 755 3.8...11.16 | Content: 6-Combination wrench 3/8"; 7/16"; 1/2"; 9/16"; 5/8"; 11/16" | |

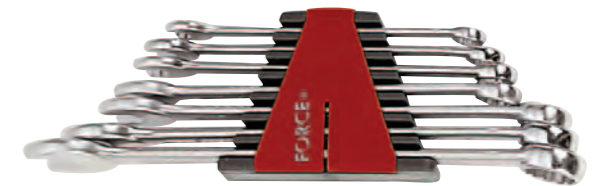

7pc Combination wrench set (MM)

| | | |
|-------------|---|------|
| 5077 | | |
| Part no. | 20/16.8/17.8/0.88' | 840g |
| 755 10...21 | Content: 7-Combination wrench 10; 12; 13; 14; 17; 19; 21 mm | |

7pc Combination wrench set (SAE)

| | | |
|---------------|---|------|
| 5077S | | |
| Part no. | 20/15.6/16.6/0.88' | 780g |
| 755 3.8...3.4 | Content: 7-Combination wrench 3/8"; 7/16"; 1/2"; 9/16"; 5/8"; 11/16"; 3/4" | |



12pc Double open end wrench set

| | | |
|-----------------|--|-------|
| 5128P | | |
| Part no. | 10/24.9/25.9/1.2' | 2490g |
| 754 0607...3032 | Content: 12-Double open end wrench 6x7; 8x9; 10x11; 12x13; 14x15; 16x17; 18x19; 20x22; 21x23; 24x27; 25x28; 30x32 mm | |



5pc Combination wrench set

| | | |
|-------------|---|-------|
| 5052 | | |
| Part no. | 6/15.6/16.6/1' | 2600g |
| 755 26...32 | Content: 5-Combination wrench 26; 27; 28; 30; 32 mm | |



8pc Combination wrench set (MM)

| | | |
|-------------|---|------|
| 5086 | | |
| Part no. | 20/17.3/18.3/1.1' | 865g |
| 755 10...22 | Content: 8-Combination wrench 10; 11; 12; 13; 14; 17; 19; 22 mm | |

8pc Combination wrench set (SAE)

| | | |
|-----------------|---|------|
| 5086S | | |
| Part no. | 20/17.3/18.3/1.1' | 865g |
| 755 3.8...13.16 | Content: 8-Combination wrench 3/8"; 7/16"; 1/2"; 9/16"; 5/8"; 11/16"; 3/4"; 13/16" | |



9pc Combination wrench set

| | | |
|-------------|--|-------|
| 5094 | | |
| Part no. | 10/12.0/13.0/1' | 1200g |
| 755 08...19 | Content: 9-Combination wrench 8; 10; 11; 12; 13; 14; 15; 17; 19 mm | |



11pc Combination wrench set (MM)

| | | |
|-------------|--|-------|
| 5115 | | |
| Part no. | 12/6.2/17.2/1' | 1350g |
| 755 08...22 | Content: 11-Combination wrench 8; 10; 11; 12; 13; 14; 15; 17; 19; 21; 22 mm | |

11pc Combination wrench set (SAE)

| | | |
|---------------|--|-------|
| 5115S | | |
| Part no. | 12/15.3/16.3/1' | 1275g |
| 755 1.4...7.8 | Content: 11-Combination wrench 1/4"; 5/16"; 3/8"; 7/16"; 1/2"; 9/16"; 5/8"; 11/16"; 3/4"; 13/16"; 7/8" | |



12pc Combination wrench set (MM)

| | | |
|-------------|--|-------|
| 5121 | | |
| Part no. | 10/15.8/16.8/1.2' | 1580g |
| 755 08...23 | Content: 12-Combination wrench 8; 10; 11; 12; 13; 14; 15; 16; 17; 19; 22; 23 mm | |

12pc Combination wrench set (SAE)

| | | |
|-----------------|--|-------|
| 5121S | | |
| Part no. | 10/16.3/17.3/1.2' | 1630g |
| 755 1.4...15.16 | Content: 12-Combination wrench 1/4"; 5/16"; 3/8"; 7/16"; 1/2"; 9/16"; 5/8"; 11/16"; 3/4"; 13/16"; 7/8"; 15/16" | |



12pc Combination wrench set (MM)

| | | |
|-------------|--|-------|
| 5123 | | |
| Part no. | 10/16.0/17.0/1.1' | 1600g |
| 755 08...22 | Content: 12-Combination wrench 8; 10; 11; 12; 13; 14; 15; 16; 17; 18; 19; 22 mm | |



13pc Combination wrench set (SAE)

| | | |
|---------------|--|-------|
| 5134 | | |
| Part no. | 6/14.1/15.1/0.9' | 2350g |
| 755 1.4...1.0 | Content: 13-Combination wrench 1/4"; 5/16"; 3/8"; 7/16"; 1/2"; 9/16"; 5/8"; 11/16"; 3/4"; 13/16"; 7/8"; 15/16"; 1" | |



14pc Combination wrench set (MM)

| | | |
|-------------|---|-------|
| 5141 | | |
| Part no. | 6/20.4/21.4/0.97' | 3400g |
| 755 10...32 | Content: 14-Combination wrench 10; 11; 12; 13; 14; 17; 19; 21; 22; 23; 24; 27; 30; 32 mm | |

14pc Combination wrench set (SAE)

| | | |
|------------------|--|-------|
| 5141S | | |
| Part no. | 6/18.9/19.9/0.97' | 3150g |
| 755 5.16...1.1.4 | Content: 14-Combination wrench 5/16"; 3/8"; 7/16"; 1/2"; 9/16"; 5/8"; 11/16"; 3/4"; 13/16"; 7/8"; 15/16"; 1"; 1-1/8"; 1-1/4" | |



16pc Combination wrench set

| | | |
|-------------|---|-------|
| 5161 | | |
| Part no. | 6/13.7/14.7/0.9' | 2283g |
| 755 06...24 | Content: 16-Combination wrench 6; 7; 8; 9; 10; 11; 12; 13; 14; 15; 16; 17; 18; 19; 22; 24 mm | |



19pc Combination wrench set

| | | |
|-------------|---|-------|
| 5191 | | |
| Part no. | 10/24.5/25.5/1.2' | 2450g |
| 755 06...24 | Content: 19-Combination wrench 6; 7; 8; 9; 10; 11; 12; 13; 14; 15; 16; 17; 18; 19; 20; 21; 22; 23; 24 mm | |



26pc Combination wrench set

| | | |
|--------------|--|-------|
| 5261P | | |
| Part no. | 3/16.6/17.6/1' | 5533g |
| 755 06...32 | Content: 26-Combination wrench 6; 7; 8; 9; 10; 11; 12; 13; 14; 15; 16; 17; 18; 19; 20; 21; 22; 23; 24; 25; 26; 27; 28; 29; 30; 32 mm | |



19pc Spline combination wrench set

| | | |
|---------------|---|-------|
| 5191Q | | |
| Part no. | 10/24.5/25.5/1.2' | 2450g |
| 755 06Q...24Q | Content: 19-Spline combination wrench M6; M7; M8; M9; M10; M11; M12; M13; M14; M15; M16; M17; M18; M19; M20; M21; M22; M23; M24 | |

NEW

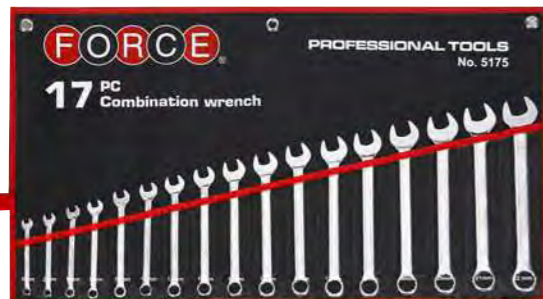

17pc Combination wrench set

| | | |
|-------------|---|-------|
| 5175 | | |
| Part no. | 10/18.7/19.7/1' | 1870g |
| 755 06...24 | Content: 17-Combination wrench 6; 7; 8; 9; 10; 11; 12; 13; 14; 15; 16; 17; 18; 19; 20; 21; 22 mm | |

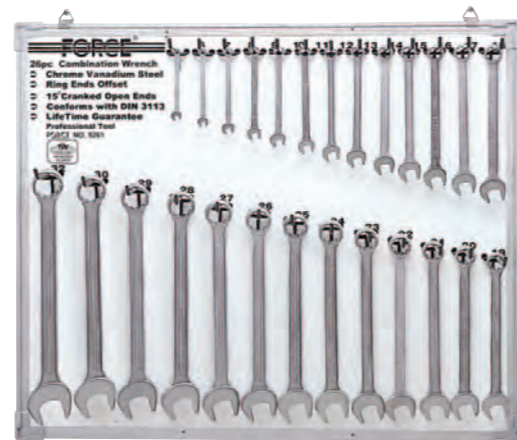

26pc Combination wrench set

| | | |
|-------------|--|-------|
| 5261 | | |
| Part no. | 3/24.6/25.6/3.6' | 8200g |
| 755 06...32 | Content: 26-Combination wrench 6; 7; 8; 9; 10; 11; 12; 13; 14; 15; 16; 17; 18; 19; 20; 21; 22; 23; 24; 25; 26; 27; 28; 29; 30; 32 mm | |



19pc 75° Offset combination wrench set

| | | |
|---------------|--|-------|
| 5192 | | |
| Part no. | 8/25.4/26.4/2.3' | 3175g |
| 755 06A...24A | Content: 19-75° Offset combination wrench 6; 7; 8; 9; 10; 11; 12; 13; 14; 15; 16; 17; 18; 19; 20; 21; 22; 23; 24 mm | |



12pc Midget combination wrench set

| | | |
|--------------|--|-------|
| 51214 | | |
| Part no. | 6/9.1/10.1/0.9' | 1516g |
| 755S 08...19 | Content: 12-Midget combination wrench 8; 9; 10; 11; 12; 13; 14; 15; 16; 17; 18; 19 mm | |

17pc 75° Offset Combination wrench set

| | | |
|---------------|--|-------|
| 5175A | | |
| Part no. | 10/23.6/24.6/1.4' | 2360g |
| 755 06A...24A | Content: 17-75° offset Combination wrench 6; 7; 8; 9; 10; 11; 12; 13; 14; 15; 16; 17; 18; 19; 20; 21; 22 mm | |



12pc Midget combination wrench set

| | | |
|---------------|--|-------|
| 51214P | | |
| Part no. | 20/20.5/21.5/1.3' | 1025g |
| 755S 08...19 | Content: 12-Midget combination wrench 8; 9; 10; 11; 12; 13; 14; 15; 16; 17; 18; 19 mm | |



6pc Star 75° offset wrench set

| | | | |
|-----------------------|--|-------------------|------|
| 5065 | | | |
| Part no. | Socket | 20/13.8/14.8/1.4' | 690g |
| 756 0608A... 2024A | Content: 6-Star 75° offset wrench E6xE8; E7xE11; E10xE12; E14xE18; E16xE22; E20xE24 | | |



8pc Flat gear wrench set (SAE)

| | | |
|----------------|--|-------|
| 50812 | | |
| Part no. | 6/10.8/11.8/0.9' | 1800g |
| 757 5.16...3.4 | Content: 8-Flat gear wrench 5/16"; 3/8"; 7/16"; 1/2"; 9/16"; 5/8"; 11/16"; 3/4" | |

NEW



10pc Flat gear wrench & holder set

| | | |
|---|---|-------|
| K51024 | | |
| Part no. | 12/13/14/1.4' | 1080g |
| 757 08...19 831 210...419 831H210 | Content: 6-Flat gear wrench 8; 10; 12; 13; 17; 19 mm 3-Gear wrench socket holder 1/4"DR.(10mm); 3/8"DR.(13mm); 1/2"DR.(19mm) 1-Gear wrench bit holder 1/4" Hex (10mm) | |



4pc Star wrench set

| | | | |
|-----------------|--|-------------------|------|
| 5041 | | | |
| Part no. | Socket | 60/21.1/22.1/1.7' | 350g |
| 756 0608...2024 | Content: 4-Star wrench E6xE8; E10xE12; E14xE18; E20xE24 | | |



7pc Star hinged socket wrench set

| | | | |
|-----------------------|---|------------------|-------|
| 5075 | | | |
| Part no. | Socket | 6/12.5/13.5/0.9' | 2080g |
| 756 0405F... 2224F | Content: 7-Star hinged socket wrench E4xE5; E6xE7; E8xE10; E11xE12; E14xE16; E18xE20; E22xE24 | | |

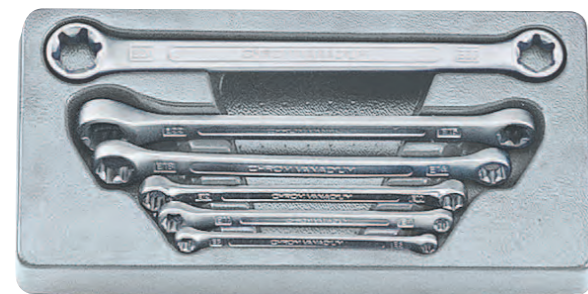

6pc Star wrench set

| | | | |
|-----------------|---|-------------------|------|
| 5062 | | | |
| Part no. | Socket | 30/17.0/18.0/1.4' | 515g |
| 756 0608...2024 | Content: 6-Star wrench E6xE8; E7xE11; E10xE12; E14xE18; E16xE22; E20xE24 | | |

NEW



9pc Flat gear wrench & holder set (SAE)

| | | |
|---|---|-------|
| K50923 | | |
| Part no. | 12/12.2/13.2/1.4' | 1017g |
| 757 5.16...3.4 831 23.8...43.4 831H23.8 | Content: 5-Flat gear wrench 5/16; 3/8"; 1/2"; 11/16"; 3/4" 3-Gear wrench socket holder 1/4"DR.(3/8"); 3/8"DR.(1/2"); 1/2"DR.(3/4") 1-Gear wrench bit holder 1/4" Hex (3/8") | |



12pc Flat gear wrench set (MM)

| | | |
|--------------|---|-------|
| 51210 | | |
| Part no. | 6/12.8/13.8/0.9' | 2130g |
| 757 08...19 | Content: 12-Flat gear wrench 8; 9; 10; 11; 12; 13; 14; 15; 16; 17; 18; 19 mm | |



12pc Flat gear wrench & holder set (SAE)

| | | |
|-----------------|--|-------|
| 51215 | | |
| Part no. | 6/8.0/9.0/0.9' | 1320g |
| 757 5.16...3.4 | Content: 8-Flat gear wrench 5/16"; 3/8"; 7/16"; 1/2"; 9/16"; 5/8"; 11/16"; 3/4" | |
| 831 23.8...43.4 | 3-Gear wrench socket holder 1/4"DR.(3/8"); 3/8"DR.(1/2"); 1/2"DR.(3/4") | |
| 831H23.8 | 1-Gear wrench bit holder 1/4"Hex(3/8") | |

NEW



16pc Flat gear wrench & holder set

| | | |
|---------------|--|-------|
| K51611 | | |
| Part no. | 6/17.3/18.3/1.5' | 2880g |
| 757 08...24 | Content: 12-Flat gear wrench 8; 10; 11; 12; 13; 14; 15; 16; 17; 19; 22; 24 mm | |
| 831 210...419 | 3-Gear wrench socket holder 1/4"DR.(10mm); 3/8"DR.(13mm); 1/2"DR.(19mm) | |
| 831H210 | 1-Gear wrench bit holder 1/4" Hex (10mm) | |

NEW



10pc Flexible gear wrench & holder set

| | | |
|----------------|---|-------|
| K51024F | | |
| Part no. | 12/14.6/15.6/1.4' | 1220g |
| 757 08F...19F | Content: 6-Flexible gear wrench 8; 10; 12; 13; 17; 19 mm | |
| 831 210...419 | 3-Gear wrench socket holder 1/4"DR.(10mm); 3/8"DR.(13mm); 1/2"DR.(19mm) | |
| 831H210 | 1-Gear wrench bit holder 1/4" Hex (10mm) | |

NEW



12pc Flexible gear wrench (SAE)

| | | |
|------------------|--|-------|
| K51225 | | |
| Part no. | 6/23.4/24.4/1.5' | 3900g |
| 757 5.16F...1.0F | Content: 12-Flexible gear wrench 5/16"; 3/8"; 7/16"; 1/2"; 9/16"; 5/8"; 11/16"; 3/4"; 13/16"; 7/8"; 15/16"; 1" | |



16pc Flat gear wrench & holder set

| | | |
|---------------|---|-------|
| 5164 | | |
| Part no. | 6/13.3/14.3/0.9' | 2215g |
| 757 08...19 | Content: 12-Flat gear wrench 8; 9; 10; 11; 12; 13; 14; 15; 16; 17; 18; 19 mm | |
| 831 210...419 | 3-Gear wrench socket holder 1/4"DR.(10mm); 3/8"DR.(13mm); 1/2"DR.(19mm) | |
| 831H210 | 1-Gear wrench bit holder 1/4"Hex(10mm) | |

NEW



9pc Flexible gear wrench & holder set (SAE)

| | | |
|------------------|---|-------|
| K50923F | | |
| Part no. | 12/13.5/14.5/1.4' | 1125g |
| 757 5.16F...3.4F | Content: 5-Flexible gear wrench 5/16; 3/8"; 1/2"; 11/16"; 3/4" | |
| 831 23.8...43.4 | 3-Gear wrench socket holder 1/4"DR.(3/8"); 3/8"DR.(1/2"); 1/2"DR.(3/4") | |
| 831H23.8 | 1-Gear wrench bit holder 1/4" Hex (3/8") | |



12pc Flexible gear wrench set (MM)

| | | |
|----------------|---|-------|
| K51210F | | |
| Part no. | 6/14.4/15.4/1.5' | 2400g |
| 757 08F...19F | Content: 12-Flexible gear wrench 8; 9; 10; 11; 12; 13; 14; 15; 16; 17; 18; 19 mm | |



8pc Reversible gear wrench set (SAE)

| | | |
|------------------|--|-------|
| 50813 | | |
| Part no. | 6/10.8/11.8/0.9' | 1800g |
| 757 5.16R...3.4R | Content: 8-Reversible gear wrench 5/16"; 3/8"; 7/16"; 1/2"; 9/16"; 5/8"; 11/16"; 3/4" | |

NEW



9pc Reversible gear wrench & holder set (SAE)

| | | |
|------------------|---|-------|
| K50923R | | |
| Part no. | 12/12.2/13.2/1.4' | 1020g |
| 757 5.16R...3.4R | Content: 5-Reversible gear wrench 5/16; 3/8"; 1/2"; 11/16"; 3/4" | |
| 831 23.8...43.4 | 3-Gear wrench socket holder 1/4"DR.(3/8"); 3/8"DR.(1/2"); 1/2"DR.(3/4") | |
| 831H23.8 | 1-Gear wrench bit holder 1/4" Hex (3/8") | |



12pc Reversible gear wrench set(MM)

| | | |
|---------------|---|-------|
| 51211 | | |
| Part no. | 6/12.9/13.9/0.9' | 2270g |
| 757 08R...19R | Content: 12-Reversible gear wrench 8; 9; 10; 11; 12; 13; 14; 15; 16; 17; 18; 19 mm | |



16pc Reversible gear wrench & holder set

| | | |
|---------------|---|-------|
| 5164R | | |
| Part no. | 6/10.7/11.7/0.9' | 1780g |
| 757 08R...19R | Content: 12-Reversible gear wrench 8; 9; 10; 11; 12; 13; 14; 15; 16; 17; 18; 19 mm | |
| 831 210...419 | 3-Gear wrench socket holder 1/4"DR.(10mm); 3/8"DR.(13mm); 1/2"DR.(19mm) | |
| 831H210 | 1-Gear wrench bit holder 1/4"Hex(10mm) | |



12pc Stubby flat gear wrench set

| | | |
|---------------|--|-------|
| K51216 | | |
| Part no. | 6/8.8/9.8/0.8' | 1466g |
| 757S 08...19 | Content: 12-Stubby flat gear wrench 8; 9; 10; 11; 12; 13; 14; 15; 16; 17; 18; 19 mm | |

NEW



10pc Reversible gear wrench & holder set

| | | |
|----------------|---|-------|
| K51024R | | |
| Part no. | 12/13.3/14.3/1.4' | 1110g |
| 757 08R...19R | Content: 6-Reversible gear wrench 8; 10; 12; 13; 17; 19 mm | |
| 831 210...419 | 3-Gear wrench socket holder 1/4"DR.(10mm); 3/8"DR.(13mm); 1/2"DR.(19mm) | |
| 831H210 | 1-Gear wrench bit holder 1/4" Hex (10mm) | |



12pc Reversible gear wrench & holder set (SAE)

| | | |
|------------------|--|-------|
| 51215R | | |
| Part no. | 6/8.0/9.0/0.9' | 1320g |
| 757 5.16R...3.4R | Content: 8-Reversible gear wrench 5/16"; 3/8"; 7/16"; 1/2"; 9/16"; 5/8"; 11/16"; 3/4" | |
| 831 23.8...43.4 | 3-Gear wrench socket holder 1/4"DR. (3/8"); 3/8"DR. (1/2"); 1/2"DR.(3/4") | |
| 831H23.8 | 1-Gear wrench bit holder 1/4"Hex (3/8") | |

NEW



16pc Reversible gear wrench & holder set

| | | |
|----------------|--|-------|
| K51611R | | |
| Part no. | 6/17.3/18.3/1.5' | 2880g |
| 757 08R...24R | Content: 12-Reversible gear wrench 8; 10; 11; 12; 13; 14; 15; 16; 17; 19; 22; 24 mm | |
| 831 210...419 | 3-Gear wrench socket holder 1/4"DR.(10mm); 3/8"DR.(13mm); 1/2"DR.(19mm) | |
| 831H210 | 1-Gear wrench bit holder 1/4" Hex (10mm) | |



6pc 45° Offset ring wrench set (MM)

| | | | |
|---------------------|--|-------------------|-------|
| 5069 | | | |
| Part no. | Socket | 10/14.6/15.6/0.7' | 1460g |
| 758 1012... 2326 | Content: 6-45° Offset ring wrench 10x12; 12x14; 14x17; 17x19; 19x21; 23x26 mm | | |

6pc 45° Offset ring wrench set (SAE)

| | | | |
|-----------------------|---|-------------------|-------|
| 5069S | | | |
| Part no. | Socket | 10/14.6/15.6/0.7' | 1460g |
| 758 1011S... 2425S | Content: 6-45° Offset ring wrench 3/8"x7/16"; 1/2"x9/16"; 9/16"x5/8"; 11/16"x3/4"; 3/4"x7/8"; 15/16"x1" | | |



8pc 45° Offset ring wrench set (MM)

| | | | |
|---------------------|--|------------------|-------|
| 5085 | | | |
| Part no. | Socket | 6/12.9/13.9/0.9' | 2150g |
| 758 0809... 2224 | Content: 8-45° Offset ring wrench 8x9; 10x11; 12x13; 14x15; 16x17; 18x19; 21x23; 22x24 mm | | |

8pc 45° Offset ring wrench set (SAE)

| | | | |
|-----------------------|---|------------------|-------|
| 5085S | | | |
| Part no. | Socket | 6/12.9/13.9/0.9' | 2150g |
| 758 0608S... 2224S | Content: 8-45° Offset ring wrench 1/4"x5/16"; 3/8"x7/16"; 7/16"x1/2"; 1/2"x9/16"; 5/8"x11/16"; 11/16"x3/4"; 13/16"x7/8"; 7/8"x15/16" | | |



6pc Midget 45° offset ring wrench set

| | | | |
|------------------|---|-------------------|------|
| 50624 | | | |
| Part no. | Socket | 30/19.0/20.0/1.6' | 633g |
| 758S 0809...1819 | Content: 6-Midget 45° offset ring wrench 8x9; 10x11; 12x13; 14x15; 16x17; 18x19 mm | | |



7pc Midget 45° offset ring wrench

| | | | |
|----------------------|---|-------------------|------|
| 50714 | | | |
| Part no. | Socket | 20/15.5/16.5/1.1' | 775g |
| 758S 0809... 1719 | Content: 7-Midget 45° offset ring wrench 8x9; 10x12; 12x14; 14x15; 14x17; 16x18; 17x19 | | |



4pc 75° offset ring wrench set

| | | | |
|-----------------|--|----------------|-------|
| 5044 | | | |
| Part no. | Socket | 6/13.7/14.7/1' | 2280g |
| 759 2326...3032 | Content: 4-75° Offset ring wrench 23x26; 24x27; 25x28; 30x32 mm | | |



6pc 75° Offset ring wrench set (MM)

| | | | |
|---------------------|--|-------------------|-------|
| 50610 | | | |
| Part no. | Socket | 10/16.3/17.3/0.9' | 1630g |
| 759 1012... 2326 | Content: 6-75° Offset ring wrench 10x12; 12x14; 14x17; 17x19; 19x21; 23x26 mm | | |

6pc 75° Offset ring wrench set (SAE)

| | | | |
|-----------------------|--|-------------------|-------|
| 50610S | | | |
| Part no. | Socket | 10/16.3/17.3/0.9' | 1630g |
| 759 1011S... 2425S | Content: 6-75° Offset ring wrench 3/8"x7/16"; 1/2"x9/16"; 5/8"x11/16"; 3/4"x7/8"; 13/16"x7/8"; 15/16"x1" | | |



7pc 75° Offset ring wrench set (SAE)

| | | | |
|-----------------------|---|------------------|-------|
| 5079S | | | |
| Part no. | Socket | 6/13.6/14.6/0.9' | 2270g |
| 759 0608S... 2425S | Content: 7-75° Offset ring wrench 1/4"x5/16"; 3/8"x7/16"; 1/2"x9/16"; 5/8"x11/16"; 3/4"x7/8"; 13/16"x7/8"; 15/16"x1" | | |



8pc 75° Offset ring wrench set (MM)

| | | | |
|---------------------|--|------------------|-------|
| 5081 | | | |
| Part no. | Socket | 6/12.4/13.4/0.9' | 2066g |
| 759 0607... 2123 | Content: 8-75° Offset ring wrench 6x7; 8x9; 10x11; 12x13; 14x15; 16x17; 18x19; 21x23 mm | | |

8pc 75° Offset ring wrench set (SAE)

| | | | |
|----------------------|--|------------------|-------|
| 5081S | | | |
| Part no. | Socket | 6/12.4/13.4/0.9' | 2066g |
| 759 0608S...2425S | Content: 8-75° Offset ring wrench 1/4"x5/16"; 3/8"x7/16"; 1/2"x9/16"; 5/8"x11/16"; 5/8"x3/4"; 3/4"x7/8"; 13/16"x7/8"; 15/16"x1" | | |

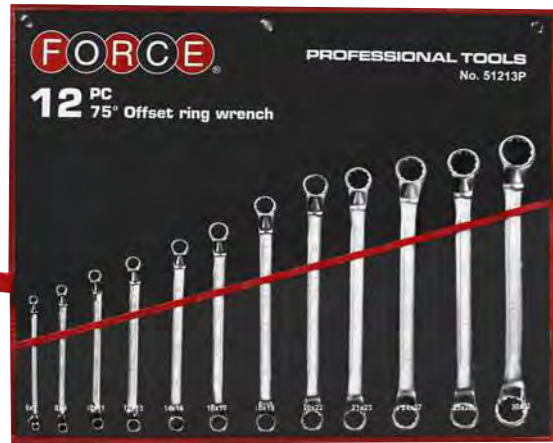

12pc 75° Offset ring wrench set

| | | | |
|-----------------|---|----------------|-------|
| 51213P | | | |
| Part no. | Socket | 6/22.1/23.1/2' | 3680g |
| 759 0607...3032 | Content: 12- 75° offset ring wrench 6x7; 8x9; 10x11; 12x13; 14x15; 16x17; 18x19; 20x22; 21x23; 24x27; 25x28; 30x32 mm | | |



6pc Extra long flat ring wrench set

| | | | |
|-----------------|---|-------------------|-------|
| 50622 | | | |
| Part no. | Socket | 12/23.8/24.8/1.2' | 1980g |
| 760 1012...1719 | Content: 6-Extra long flat ring wrench 10x12; 12x14; 13x15; 14x17; 16x18; 17x19 mm | | |

NEW

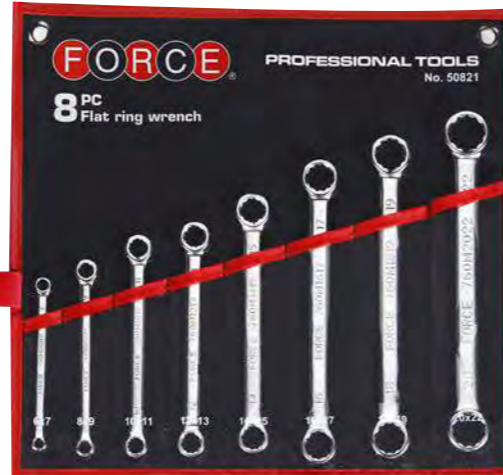

8pc 15° Bowed double ring wrench set

| | | |
|-------------------|--|------|
| 50821A | | |
| Part no. | 10/8.0/9.0/0.69' | 800g |
| 760 0607A...2022A | Content: 8-15° Bowed double ring wrench 6x7; 8x9; 10x11; 12x13; 14x15; 16x17; 18x19; 20x22 mm | |

NEW



8pc Flat ring wrench set

| | | |
|------------------|--|------|
| 50821 | | |
| Part no. | 10/8.0/9.0/0.69' | 800g |
| 760M 0607...2022 | Content: 8-Double ring wrench 6x7; 8x9; 10x11; 12x13; 14x15; 16x17; 18x19; 20x22 mm | |

NEW



12pc Double ring wrench set (15 degree bowed)

| | | | |
|-------------------|--|-------------------|-------|
| T51226A | | | |
| Part no. | Socket | 6/14.1/15.1/0.73' | 2350g |
| 760 0607A...3032A | Content: 12-Double ring wrench 6x7; 8x9; 10x11; 12x13; 14x15; 16x17; 18x19; 20x22; 21x23; 22x24; 26x28; 30x32 mm | | |

NEW



12pc Flat ring wrench set

| | | | |
|------------------|---|-------------------|-------|
| T51226 | | | |
| Part no. | Socket | 6/14.0/15.0/0.73' | 2333g |
| 760M 0607...3032 | Content: 12-Flat ring wrench 6x7; 8x9; 10x11; 12x13; 14x15; 16x17; 18x19; 20x22; 21x23; 22x24; 26x28; 30x32 mm | | |

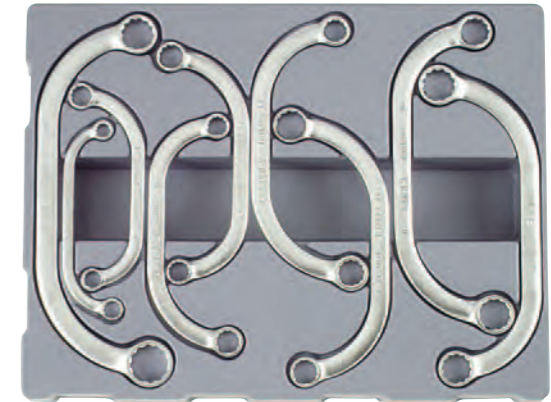

9pc Half-moon ring wrench set

| | | | |
|-----------------|--|----------------|-------|
| 50911 | | | |
| Part no. | Socket | 6/8.3/9.8/1.3' | 1380g |
| 761 0810...1922 | Content: 9-Half-moon ring wrench 8x10; 10x12; 11x13; 12x14; 13x15; 14x17; 16x18; 17x19; 19x22 mm | | |

NEW



6pc S-form ring wrench set

| | | |
|-------------------|---|-------|
| 50634 | | |
| Part no. | 10/11.0/12.0/1.1' | 1100g |
| 761 1012A...2224A | Content: 6-S-form ring wrench 10x12; 11x13; 14x15; 16x18; 17x19; 22x24 | |



8pc Double ended 6pt.-6pt. socket wrench set

| | | | |
|-----------------|--|----------------|-------|
| 50817 | | | |
| Part no. | Socket | 6/7.2/8.2/0.9' | 1200g |
| 762 0607...1819 | Content: 7-Double ended 6pt.-6pt. socket wrench 6x7; 8x9; 10x11; 12x13; 14x15; 16x17; 18x19 | | |
| 762220 | 1-Bar for double ended socket wrench 220mmL | | |



14pc Double ended socket wrench set

| | | | |
|-----------------|--|------------------|-------|
| 5144 | | | |
| Part no. | Socket | 3/15.9/16.9/1.5' | 5300g |
| 762 0809...3032 | Content: 12-Double ended 6pt.-6pt. Socket wrench 8x9; 10x11; 12x13; 14x15; 16x17; 18x19; 20x22; 21x23; 24x26; 25x28; 27x29; 30x32 | | |
| 762 220...300 | 2-Bar for double ended socket wrench 220mmL & 300mmL (762220 is for 7620809 to 7622123) (762300 is for 7622426 to 7623032) | | |

NEW



11pc Double ended socket wrench & adjustable wrench set

| | | | |
|-----------------|--|------------------|-------|
| K51113 | | | |
| Part no. | Socket | 6/14.7/15.7/1.5' | 2463g |
| 649200D | Content: 1-Ratchet-function adjustable wrench 8" | | |
| 762 0607...2123 | 9-Double ended 6pt.-6pt. socket wrench 6x7; 8x9; 10x11; 12x13; 14x15; 16x17; 18x19; 20x22; 21x23 | | |
| 762220 | 1-Bar for double ended socket wrench 220mmL | | |



7pc Hex key set (MM)

| | | | |
|--------------|--|-------------------|------|
| 5072 | | | |
| Part no. | Tip | 60/16.2/17.2/1.1' | 270g |
| 764 025...10 | Content: 7-Hex key 2.5; 3; 4; 5; 6; 8; 10 mm | | |

7pc Hex key set (SAE)

| | | | |
|----------------|--|-------------------|------|
| 5072S | | | |
| Part no. | Tip | 60/15.7/16.7/1.1' | 261g |
| 764 3.32...3.8 | Content: 7-Hex key 3/32"; 1/8"; 5/32"; 3/16"; 1/4"; 5/16"; 3/8" | | |



7pc Hex long key set (MM)

| | | | |
|----------------|---|-----------------|------|
| 5072L | | | |
| Part no. | Tip | 50/18.5/19.5/1' | 370g |
| 764 025L...10L | Content: 7-Hex long key 2.5; 3; 4; 5; 6; 8; 10 mm | | |

7pc Hex long key set (SAE)

| | | | |
|------------------|---|-----------------|------|
| 5072LS | | | |
| Part no. | Tip | 50/17.8/18.8/1' | 356g |
| 764 3.32L...3.8L | Content: 7-Hex long key 3/32"; 1/8"; 5/32"; 3/16"; 1/4"; 5/16"; 3/8" | | |



7pc Hex extra long key set (MM)

| | | | |
|------------------|---|-------------------|------|
| 5072XL | | | |
| Part no. | Tip | 40/18.2/19.2/1.1' | 450g |
| 764 025XL...10XL | Content: 7-Hex extra long key 2.5; 3; 4; 5; 6; 8; 10 mm | | |

7pc Hex extra long key set (SAE)

| | | | |
|--------------------|---|-------------------|------|
| 5072XLS | | | |
| Part no. | Tip | 40/17.5/18.5/1.1' | 450g |
| 764 3.32XL...3.8XL | Content: 7-Hex extra long key 3/32"; 1/8"; 5/32"; 3/16"; 1/4"; 5/16"; 3/8" | | |



7pc Hex key set (Folding)

| | | | |
|--------------|--|-------------------|------|
| 5072F | | | |
| Part no. | Tip | 40/17.0/18.0/1.2' | 425g |
| 5072F | Content: 7-Hex key (Folding) 2.5; 3; 4; 5; 6; 8; 10 mm | | |

7pc Hex key set (Folding) (SAE)

| | | | |
|---------------|--|-------------------|------|
| 5072FS | | | |
| Part no. | Tip | 40/17.0/18.0/1.2' | 425g |
| 5072FS | Content: 7-Hex key (Folding) 3/32"; 1/8"; 5/32"; 3/16"; 1/4"; 5/16"; 3/8" | | |



7pc Hex key set (MM)

| | | | |
|--------------|---|-----------------|------|
| 5076 | | | |
| Part no. | Tip | 100/9.6/10.6/1' | 100g |
| 764 015...06 | Content: 7-Hex key 1.5; 2; 2.5; 3; 4; 5; 6 mm | | |

7pc Hex key set (SAE)

| | | | |
|----------------|---|-----------------|------|
| 5076S | | | |
| Part no. | Tip | 100/9.6/10.6/1' | 100g |
| 764 1.16...1.4 | Content: 7-Hex key 1/16"; 5/64"; 3/32"; 1/8"; 5/32"; 3/16"; 1/4" | | |



7pc Hex key set (Folding)

| | | | |
|--------------|--|--------------------|------|
| 5076F | | | |
| Part no. | Tip | 100/15.0/16.0/1.6' | 150g |
| 5076F | Content: 7-Hex key (Folding) 1.5; 2; 2.5; 3; 4; 5; 6mm | | |

7pc Hex key set (Folding) (SAE)

| | | | |
|----------------------------------|---|--------------------|------|
| 5076FS <small>NEW</small> | | | |
| Part no. | Tip | 100/15.0/16.0/1.6' | 150g |
| 5076FS | Content: 7-Hex key (Folding) 1/16"; 5/64"; 3/32"; 1/8"; 5/32"; 3/16"; 1/4" | | |



9pc Hex key set (MM)

| | | | |
|--------------|--|-------------------|------|
| 5093 | | | |
| Part no. | Tip | 50/14.4/15.4/1.3' | 288g |
| 764 015...10 | Content: 9-Hex key 1.5; 2; 2.5; 3; 4; 5; 6; 8; 10 mm | | |

9pc Hex key set (SAE)

| | | | |
|----------------|--|-------------------|------|
| 5093S | | | |
| Part no. | Tip | 60/17.2/18.2/1.4' | 287g |
| 764 1.16...3.8 | Content: 9-Hex key 1/16"; 5/64"; 3/32"; 1/8"; 5/32"; 3/16"; 1/4"; 5/16"; 3/8" | | |



9pc Hex long key set (MM)

| | | | |
|----------------|---|-------------------|------|
| 5093L | | | |
| Part no. | Tip | 50/19.5/20.5/2.2' | 390g |
| 764 015L...10L | Content: 9-Hex long key 1.5; 2; 2.5; 3; 4; 5; 6; 8; 10 mm | | |

9pc Hex long key set (SAE)

| | | | |
|------------------|---|-------------------|------|
| 5093LS | | | |
| Part no. | Tip | 60/22.8/23.8/1.9' | 380g |
| 764 1.16L...3.8L | Content: 9-Hex long key 1/16"; 5/64"; 3/32"; 1/8"; 5/32"; 3/16"; 1/4"; 5/16"; 3/8" | | |

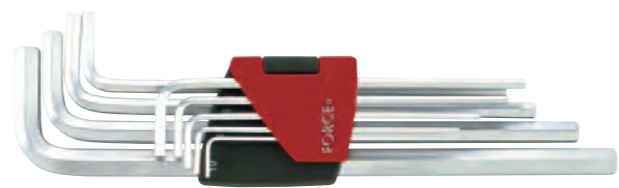

9pc Hex extra long key set (MM)

| | | | |
|------------------|---|-------------------|------|
| 5093XL | | | |
| Part no. | Tip | 40/19.0/20.0/2.1' | 475g |
| 764 015XL...10XL | Content: 9-Hex extra long key 1.5; 2; 2.5; 3; 4; 5; 6; 8; 10 mm | | |

9pc Hex extra long key set (SAE)

| | | | |
|--------------------|---|-------------------|------|
| 5093XLS | | | |
| Part no. | Tip | 40/18.6/19.6/1.9' | 465g |
| 764 1.16XL...3.8XL | Content: 9-Hex extra long key 1/16"; 5/64"; 3/32"; 1/8"; 5/32"; 3/16"; 1/4"; 5/16"; 3/8" | | |



10pc Hex key set

| | | | |
|---------------|--|-------------------|------|
| 5102 | | | |
| Part no. | Tip | 50/13.0/14.0/1.2' | 260g |
| 764 0127...10 | Content: 10-Hex key 1.27; 1.5; 2; 2.5; 3; 4; 5; 6; 8; 10 mm | | |

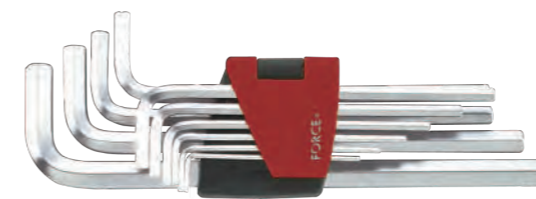

10pc Hex long key set

| | | | |
|-----------------|---|-------------------|------|
| 5102L | | | |
| Part no. | Tip | 50/19.4/20.4/2.2' | 388g |
| 764 0127L...10L | Content: 10-Hex long key 1.27; 1.5; 2; 2.5; 3; 4; 5; 6; 8; 10 mm | | |

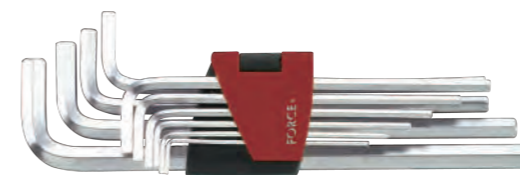

10pc Hex extra long key set

| | | | |
|-------------------|---|-------------------|------|
| 5102XL | | | |
| Part no. | Tip | 40/17.5/18.5/2.1' | 438g |
| 764 0127XL...10XL | Content: 10-Hex extra long key 1.27; 1.5; 2; 2.5; 3; 4; 5; 6; 8; 10 mm | | |



10pc Hex key set (SAE)

| | | | |
|----------------|---|-------------------|------|
| 5109S | | | |
| Part no. | Tip | 60/27.0/28.0/2.2' | 450g |
| 764 1.16...1.2 | Content: 10-Hex key 1/16"; 5/64"; 3/32"; 1/8"; 5/32"; 3/16"; 1/4"; 5/16"; 3/8"; 1/2" | | |



11pc Hex key set

| | | | |
|--------------|---|-------------------|------|
| 5116 | | | |
| Part no. | Tip | 40/20.9/21.9/1.6' | 520g |
| 764 015...12 | Content: 11-Hex key 1.5; 2; 2.5; 3; 4; 5; 6; 7; 8; 10; 12 mm | | |

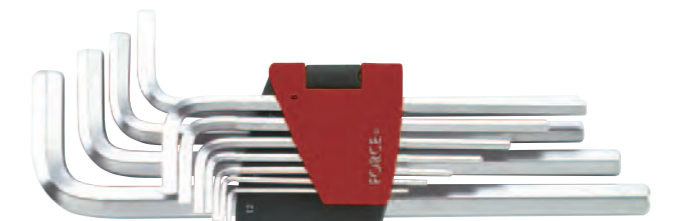

11pc Hex long key set

| | | | |
|----------------|--|--------------------|------|
| 5116L | | | |
| Part no. | Tip | 30/21.8/22.8/1.58' | 726g |
| 764 015L...12L | Content: 11-Hex long key 1.5; 2; 2.5; 3; 4; 5; 6; 7; 8; 10; 12 mm | | |

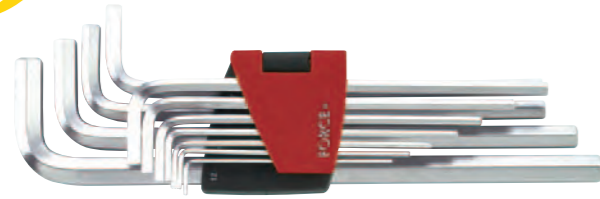

11pc Hex extra long key set

| | | | |
|------------------|--|-------------------|------|
| 5116XL | | | |
| Part no. | Tip | 30/27.5/28.5/1.7' | 918g |
| 764 015XL...12XL | Content: 11-Hex extra long key 1.5; 2; 2.5; 3; 4; 5; 6; 7; 8; 10; 12 mm | | |



13pc Hex key set (MM)

| | | | |
|-------------|--|-------------------|-------|
| 5137 | | | |
| Part no. | Tip | 12/23.4/24.4/1.3' | 1950g |
| 764 02...19 | Content: 13-Hex key 2; 2.5; 3; 4; 5; 6; 7; 8; 10; 12; 14; 17; 19 mm | | |

13pc Hex key set (SAE)

| | | | |
|----------------|---|-------------------|-------|
| 5137S | | | |
| Part no. | Tip | 12/23.4/24.4/1.3' | 1950g |
| 764 1.16...3.4 | Content: 13-Hex key 1/16"; 5/64"; 3/32"; 1/8"; 5/32"; 3/16"; 1/4"; 5/16"; 3/8"; 1/2"; 9/16"; 5/8"; 3/4" | | |



13pc Hex extra long key set (MM)

| | | | |
|-----------------|---|-------------------|-------|
| 5137XL | | | |
| Part no. | Tip | 6/18.2/19.2/0.68' | 3030g |
| 764 02XL...19XL | Content: 13-Hex extra long key 2; 2.5; 3; 4; 5; 6; 7; 8; 10; 12; 14; 17; 19 mm | | |

NEW



6pc T shaped hex key set

| | | | |
|---------------|--|-----------------|------|
| 50638 | | | |
| Part no. | Tip | 20/7.6/8.6/0.6' | 380g |
| 764 02T...06T | Content: 6-T shape hex key 2; 2.5; 3; 4; 5; 6 mm | | |

NEW



6pc Adjustable T-shaped hex key set

| | | | |
|-----------------|--|-----------------|------|
| 50638A | | | |
| Part no. | Tip | 20/7.6/8.6/0.6' | 380g |
| 764 02TA...06TA | Content: 6- Adjustable T-shape hex key 2; 2.5; 3; 4; 5; 6 mm | | |

NEW



6pc T shaped hex key set

| | | | |
|---------------|---|-------------------|-------|
| 50639 | | | |
| Part no. | Tip | 10/10.2/11.2/0.6' | 1020g |
| 764 03T...10T | Content: 6-T shape hex key 3; 4; 5; 6; 8; 10 mm | | |

NEW



6pc Adjustable T-shaped hex key set

| | | | |
|-----------------|---|-------------------|-------|
| 50639A | | | |
| Part no. | Tip | 10/10.2/11.2/0.6' | 1020g |
| 764 03TA...10TA | Content: 6- Adjustable T-shape hex key 3; 4; 5; 6; 8; 10 mm | | |

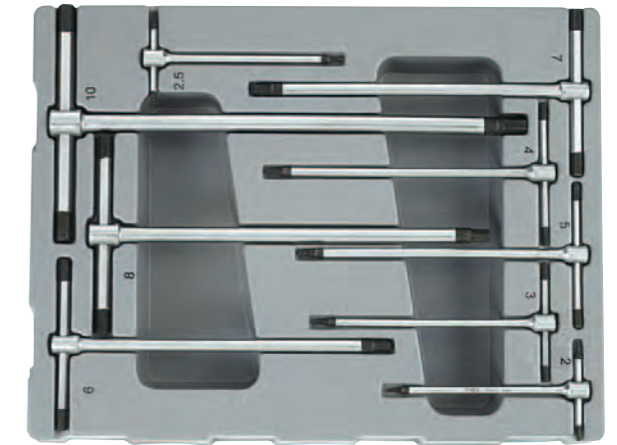

9pc T shaped hex key set

| | | | |
|---------------|---|----------------|-------|
| 50912 | | | |
| Part no. | Tip | 6/7.9/9.4/1.3' | 1316g |
| 764 02T...10T | Content: 9-T shaped hex key 2; 2.5; 3; 4; 5; 6; 7; 8; 10 mm | | |

NEW

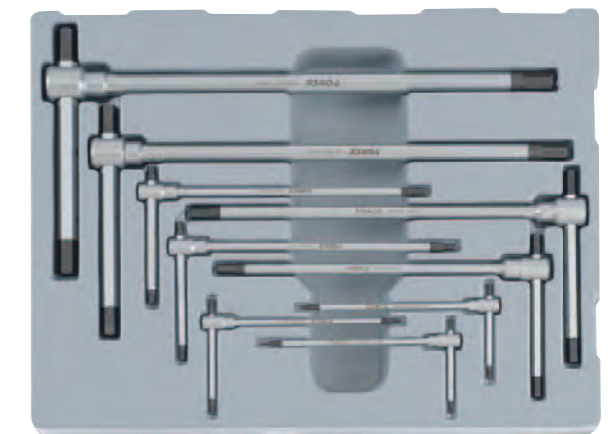

9pc Adjustable T-shaped hex key set

| | | | |
|-----------------|---|------------------|-------|
| 50919 | | | |
| Part no. | Tip | 6/10.5/11.5/1.3' | 1750g |
| 764 02TA...12TA | Content: 9-Adjustable T-shape hex key 2; 2.5; 3; 4; 5; 6; 8; 10; 12mm | | |



7pc Hex ball point long key set (MM)

| | | | | |
|----------------|--|-----|-----------------|------|
| 5072LB | | | | |
| Part no. | Tip | Tip | 50/18.5/19.5/1' | 370g |
| 765 025L...10L | Content: 7-Hex ball point long key 2.5; 3; 4; 5; 6; 8; 10 mm | | | |

7pc Hex ball point long key set (SAE)

| | | | | |
|------------------|--|-----|-----------------|------|
| 5072LBS | | | | |
| Part no. | Tip | Tip | 50/17.8/18.8/1' | 356g |
| 765 3.32L...3.8L | Content: 7-Hex ball point long key 3/32"; 1/8"; 5/32"; 3/16"; 1/4"; 5/16"; 3/8" | | | |



7pc Hex ball point extra long key set (MM)

| | | | | |
|------------------|--|-----|-------------------|------|
| 5072XLB | | | | |
| Part no. | Tip | Tip | 40/18.2/19.2/1.1' | 455g |
| 765 025XL...10XL | Content: 7-Hex ball point extra long key 2.5; 3; 4; 5; 6; 8; 10 mm | | | |

7pc Hex ball point extra long key set (SAE)

| | | | | |
|--------------------|--|-----|-------------------|------|
| 5072XLBS | | | | |
| Part no. | Tip | Tip | 40/17.5/18.5/1.1' | 438g |
| 765 3.32XL...3.8XL | Content: 7-Hex ball point extra long key 3/32"; 1/8"; 5/32"; 3/16"; 1/4"; 5/16"; 3/8" | | | |



7pc Hex ball point key set (Folding)

| | | | | |
|---------------|---|-----|-------------------|------|
| 5072BF | | | | |
| Part no. | Tip | Tip | 40/17.0/18.0/1.2' | 425g |
| 5072BF | Content: 7-Hex ball point key (Folding) 2.5; 3; 4; 5; 6; 8; 10 mm | | | |



9pc Hex ball point long key set (MM)

| | | | | |
|----------------|--|-----|-------------------|------|
| 5093LB | | | | |
| Part no. | Tip | Tip | 50/19.5/20.5/2.2' | 390g |
| 765 015L...10L | Content: 9-Hex ball point long key 1.5; 2; 2.5; 3; 4; 5; 6; 8; 10 mm | | | |

9pc Hex ball point long key set (SAE)

| | | | | |
|------------------|--|-----|-------------------|------|
| 5093LBS | | | | |
| Part no. | Tip | Tip | 60/22.8/23.8/1.9' | 380g |
| 765 1.16L...3.8L | Content: 9-Hex ball point long key 1/16"; 5/64"; 3/32"; 1/8"; 5/32"; 3/16"; 1/4"; 5/16"; 3/8" | | | |

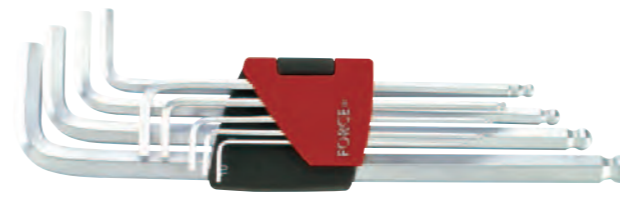

9pc Hex ball point extra long key set (MM)

| | | | | |
|------------------|--|-----|-------------------|------|
| 5093XLB | | | | |
| Part no. | Tip | Tip | 40/17.5/18.5/2.1' | 440g |
| 765 015XL...10XL | Content: 9-Hex ball point extra long key 1.5; 2; 2.5; 3; 4; 5; 6; 8; 10 mm | | | |

9pc Hex ball point extra long key set (SAE)

| | | | | |
|--------------------|--|-----|-------------------|------|
| 5093XLBS | | | | |
| Part no. | Tip | Tip | 40/18.6/19.6/1.9' | 465g |
| 765 1.16XL...3.8XL | Content: 9-Hex ball point extra long key 1/16"; 5/64"; 3/32"; 1/8"; 5/32"; 3/16"; 1/4"; 5/16"; 3/8" | | | |



10pc Hex ball point long key set

| | | | | |
|-----------------|--|-----|-------------------|------|
| 5102LB | | | | |
| Part no. | Tip | Tip | 50/19.4/20.4/2.2' | 386g |
| 765 0127L...10L | Content: 10-Hex ball point long key 1.27; 1.5; 2; 2.5; 3; 4; 5; 6; 8; 10 mm | | | |



10pc Hex ball point extra long key set

| | | | | |
|-------------------|--|-----|-------------------|------|
| 5102XLB | | | | |
| Part no. | Tip | Tip | 40/17.5/18.5/2.1' | 438g |
| 765 0127XL...10XL | Content: 10-Hex ball point extra long key 1.27; 1.5; 2; 2.5; 3; 4; 5; 6; 8; 10 mm | | | |



11pc Hex ball point long key set

| | | | | |
|----------------|---|-----|--------------------|------|
| 5116LB | | | | |
| Part no. | Tip | Tip | 30/21.8/22.8/1.58' | 726g |
| 765 015L...12L | Content: 11-Hex ball point long key 1.5; 2; 2.5; 3; 4; 5; 6; 7; 8; 10; 12 mm | | | |

NEW



6pc Hex ball point grip key set

| | | | | |
|---------------|--|-----|--------------------|------|
| 50637 | | | | |
| Part no. | Tip | Tip | 30/21.8/22.8/1.58' | 726g |
| 765 02G...08G | Content: 6-Hex ball point grip key 2; 3; 4; 5; 6; 8 mm | | | |

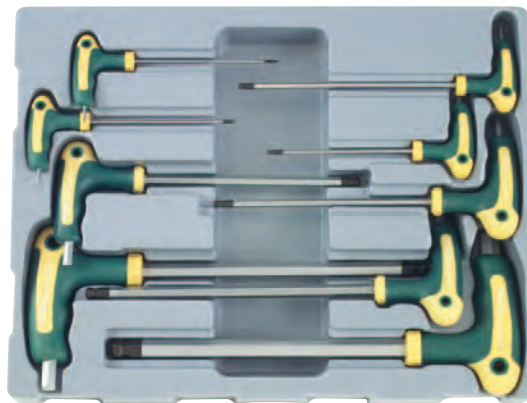

9pc Hex ball point grip key set (SAE)

| | | | | |
|------------------|---|-----|----------------|-------|
| 50910BS | | | | |
| Part no. | Tip | Tip | 6/8.0/9.0/1.3' | 1330g |
| 765 5.64G...1.2G | Content: 9-Hex ball point grip key 5/64"; 3/32"; 1/8"; 5/32"; 3/16"; 1/4"; 5/16"; 3/8"; 1/2" | | | |

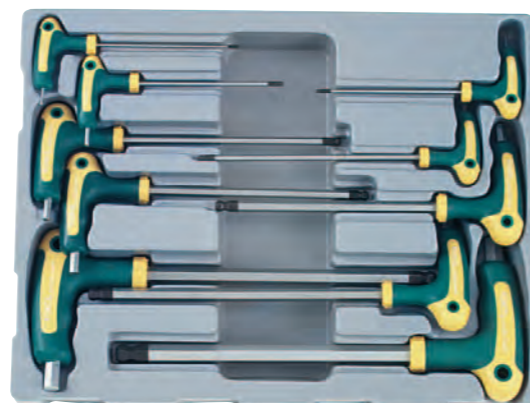

10pc Hex ball point grip key set

| | | | | |
|---------------|--|-----|-----------------|-------|
| 5106B | | | | |
| Part no. | Tip | Tip | 6/9.3/10.3/1.3' | 1550g |
| 765 02G...12G | Content: 10-Hex ball point grip key 2; 2.5; 3; 4; 5; 6; 7; 8; 10; 12 mm | | | |

NEW

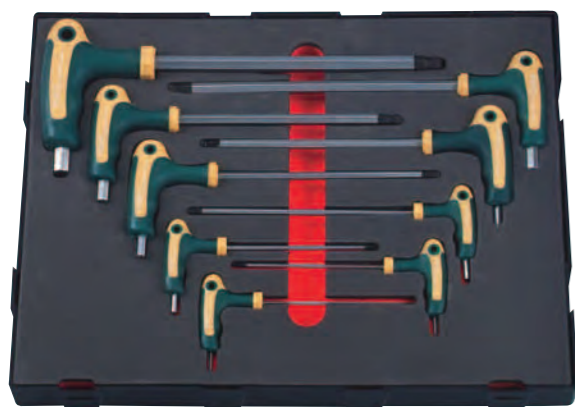

9pc Hex & Hex-ball grip key set (SAE)

| | | | | |
|------------------|---|-----|------------------|-------|
| K50916S | | | | |
| Part no. | Tip | Tip | 6/10.8/11.8/1.5' | 1800g |
| 765 5.64G...1.2G | Content: 9-Hex & Hex-ball grip key 5/64"; 3/32"; 1/8"; 5/32"; 3/16"; 1/4"; 5/16"; 3/8"; 1/2" | | | |



6pc Star key set

| | | | |
|-------------|--|-------------------|------|
| 5063 | | | |
| Part no. | Tip | 48/24.3/25.3/0.9' | 500g |
| 766 40...60 | Content: 6-Star key T40; T45; T47; T50; T55; T60 | | |

6pc Star tamperproof key set

| | | | |
|--------------|---|-------------------|------|
| 5063T | | | |
| Part no. | Tip | 48/24.0/25.0/0.9' | 500g |
| 767 40...60 | Content: 6-Star tamperproof key T-40H; T-45H; T-47H; T-50H; T-55H; T-60H | | |



7pc Star key set

| | | | |
|---------------|---|-------------------|------|
| 5071 | | | |
| Part no. | Tip | 80/11.0/12.0/0.8' | 138g |
| 766 10D...40D | Content: 7-Star key T10; T15; T20; T25; T27; T30; T40 | | |

7pc Star tamperproof key set

| | | | |
|---------------|--|-------------------|------|
| 5071T | | | |
| Part no. | Tip | 80/11.0/12.0/0.8' | 138g |
| 767 10D...40D | Content: 7-Star tamperproof key T-10H; T-15H; T-20H; T-25H; T-27H; T-30H; T-40H | | |



8pc Star key set (Folding)

| | | | |
|--------------|---|--------------------|------|
| 5087F | | | |
| Part no. | Tip | 100/13.0/14.0/1.6' | 130g |
| 5087F | Content: 8-Star key (Folding) T5; T6; T7; T8; T9; T10; T15; T20 | | |

8pc Star tamperproof key set (Folding)

| | | | |
|---------------|--|--------------------|------|
| 5087TF | | | |
| Part no. | Tip | 100/13.0/14.0/1.6' | 130g |
| 5087TF | Content: 8-Star tamperproof key (Folding) T-5H; T-6H; T-7H; T-8H; T-9H; T-10H; T-15H; T-20H | | |



8pc Star key set (Folding)

| | | | |
|--------------|--|-------------------|------|
| 5083F | | | |
| Part no. | Tip | 40/13.5/14.5/1.2' | 338g |
| 5083F | Content: 8-Star key (Folding) T9; T10; T15; T20; T25; T27; T30; T40 | | |

8pc Star tamperproof key set (Folding)

| | | | |
|---------------|--|-------------------|------|
| 5083TF | | | |
| Part no. | Tip | 40/13.5/14.5/1.2' | 338g |
| 5083TF | Content: 8-Star tamperproof key (Folding) T-9H; T-10H; T-15H; T-20H; T-25H; T-27H; T-30H; T-40H | | |



9pc Star key set

| | | | |
|-------------|--|--------------------|------|
| 5098 | | | |
| Part no. | Tip | 80/20.0/21.0/1.67' | 250g |
| 766 10...50 | Content: 9-Star key T10; T15; T20; T25; T27; T30; T40; T45; T50 | | |

9pc Star tamperproof key set

| | | | |
|--------------|---|--------------------|------|
| 5098T | | | |
| Part no. | Tip | 80/20.0/21.0/1.67' | 250g |
| 767 10...50 | Content: 9-Star tamperproof key T-10H; T-15H; T-20H; T-25H; T-27H; T-30H; T-40H; T-45H; T-50H | | |



9pc Star long key set

| | | | |
|--------------|-----|-------------------|------|
| 5098L | | | |
| Part no. | Tip | 50/16.5/17.5/1.8' | 870g |

766 10L...50L
Content:
9-Star long key
T10; T15; T20; T25; T27;
T30; T40; T45; T50

9pc Star tamperproof long key set

| | | | |
|---------------|-----|-------------------|------|
| 5098LT | | | |
| Part no. | Tip | 50/16.5/17.5/1.8' | 870g |

767 10L...50L
Content:
9-Star tamperproof long key
T-10H; T-15H; T-20H; T-25H;
T-27H; T-30H; T-40H; T-45H;
T-50H



9pc Star long key set

| | | | |
|--------------|-----|-------------------|------|
| 5099L | | | |
| Part no. | Tip | 30/22.0/23.0/0.7' | 733g |

766 20L...60L
Content:
9-Star long key
T20; T25; T27; T30; T40;
T45; T50; T55; T60

9pc Star tamperproof long key set

| | | | |
|---------------|-----|-------------------|------|
| 5099LT | | | |
| Part no. | Tip | 30/22.0/23.0/0.7' | 733g |

767 20L...60L
Content:
9-Star tamperproof long key
T-20H; T-25H; T-27H; T-30H;
T-40H; T-45H; T-50H; T-55H;
T-60H



15pc Star key set

| | | | |
|-------------|-----|--------------------|------|
| 5151 | | | |
| Part no. | Tip | 20/13.4/14.4/0.76' | 670g |

766 06...60
Content:
15-Star key
T6; T7; T8; T9; T10; T15; T20; T25;
T27; T30; T40; T45; T50; T55; T60

15pc Star tamperproof key set

| | | | |
|--------------|-----|--------------------|------|
| 5151T | | | |
| Part no. | Tip | 20/11.7/12.7/0.76' | 585g |

767 06...60
Content:
15-Star tamperproof key
T-6H; T-7H; T-8H; T-9H; T-10H;
T-15H; T-20H; T-25H; T-27H; T-30H;
T-40H; T-45H; T-50H; T-55H; T-60H



15pc Star long key set

| | | | |
|--------------|-----|-------------------|------|
| 5151L | | | |
| Part no. | Tip | 20/17.5/18.5/1.3' | 875g |

766 06L...60L
Content:
15-Star long key
T6; T7; T8; T9; T10; T15; T20; T25;
T27; T30; T40; T45; T50; T55; T60

15pc Star tamperproof long key set

| | | | |
|---------------|-----|-------------------|------|
| 5151LT | | | |
| Part no. | Tip | 20/13.4/14.4/1.3' | 670g |

767 06L...60L
Content:
15-Star tamperproof long key
T-6H; T-7H; T-8H; T-9H; T-10H;
T-15H; T-20H; T-25H; T-27H; T-30H;
T-40H; T-45H; T-50H; T-55H; T-60H

NEW



9pc Star & star ball point long key set

| | | | | |
|---------------|-----|-------------------|------|--|
| 5098LB | | | | |
| Part no. | Tip | 50/16.5/17.5/1.8' | 300g | |

766 10BL...50BL
Content:
9-Star & Star ball point long key
T10; T15; T20; T25; T27;
T30; T40; T45; T50

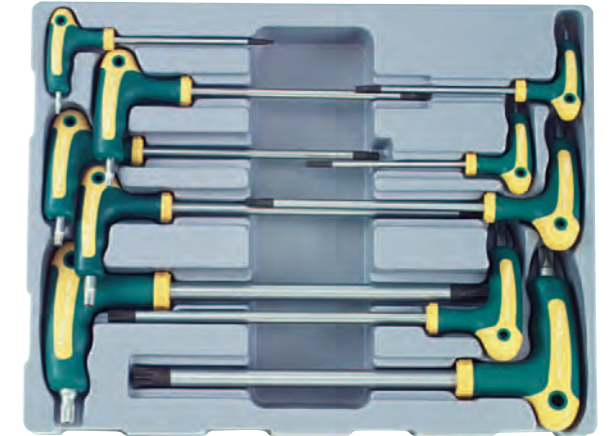

10pc Star tamperproof grip key set

| | | | | |
|---------------|-----|-----|----------------|-------|
| 51010T | | | | |
| Part no. | Tip | Tip | 6/7.8/8.8/1.3' | 1300g |

767 10G...55G
Content:
10-Star tamperproof grip key
T10xT-10H; T15xT-15H;
T20xT-20H; T25xT-25H;
T27xT-27H; T30xT-30H;
T40xT-40H; T45xT-45H;
T50xT-50H; T55xT-55H



9pc Five-sided star tamperproof L key set

| | | | |
|--------------|-----|--------------------|------|
| 50913 | | | |
| Part no. | Tip | 80/20.0/21.0/1.67' | 250g |

76F 10...50
Content:
9-Five-sided star tamperproof L key
TS10; TS15; TS20; TS25; TS27;
TS30; TS40; TS45; TS50

5pc Spline key set

| | | | |
|-------------|-----|-------------------|------|
| 5501 | | | |
| Part no. | Tip | 30/16.0/17.0/0.9' | 533g |

768 05K...12K
Content:
5-Spline key
M5; M6; M8; M10; M12

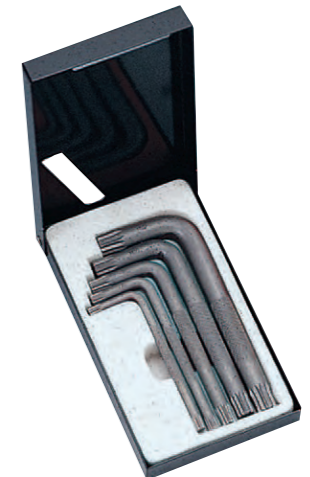



9pc Hex nut driver T handle set

| | | | |
|----------------|--|------------------|-------|
| 2095 | | | |
| Part no. | Socket | 6/11.3/12.3/2.4' | 1880g |
| 774300 05...13 | Content: 9-Hex nut driver T handle 5; 6; 7; 8; 9; 10; 11; 12; 13mm (300mmL) | | |

9pc Hex nut driver T handle set (SAE)

| | | | |
|-----------------------|---|------------------|-------|
| 2095S NEW | | | |
| Part no. | Tip | 6/10.5/11.5/2.4' | 1750g |
| 774300 3.16...9.16 | Content: 9-Hex nut driver T handle (300mmL) 3/16"; 1/4"; 9/32"; 5/16"; 11/32"; 3/8"; 7/16"; 1/2"; 9/16" | | |



9pc Star nut driver T handle set

| | | | |
|-------------|---|------------------|-------|
| 2096 | | | |
| Part no. | Socket | 6/10.5/11.5/2.4' | 1750g |
| 776 04...16 | Content: 9-Star nut driver T handle E4; E5; E6; E7; E8; E10; E12; E14; E16(260mmL) | | |

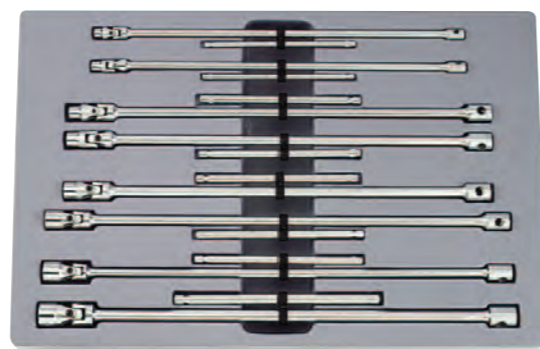

8pc Universal long nut driver set

| | | |
|--|--|-------|
| 50816 | | |
| Part no. | 6/24.2/25.2/2.8' | 4030g |
| 7842 07U...08U 7843 10U...17U 7844 19U | Content: 8-Universal long nut driver 1/4" DR.: 7; 8 mm 3/8" DR.: 10; 12; 13; 14; 17 mm 1/2" DR.: 19 mm | |



8pc Ratchet ring wrench

| | | | |
|---------------------|---|------------------|-----|
| 50810 | | | |
| Part no. | Socket | 6/12.0/13.0/0.9' | 2kg |
| 824 0607... 2122 | Content: 8-Ratchet ring wrench 6x7; 8x9; 10x11; 12x13; 14x15; 16x18; 17x19; 21x22 mm | | |



8pc 15° Offset ratchet ring wrench

| | | | |
|---------------------|--|------------------|-------|
| 50811 | | | |
| Part no. | Socket | 6/13.1/14.1/0.9' | 2180g |
| 825 0607... 2122 | Content: 8-15° Offset ratchet ring wrench 6x7; 8x9; 10x11; 12x13; 14x15; 16x18; 17x19; 21x22 mm | | |



6pc 15° Offset star ratchet ring wrench set

| | | | |
|---------------------|---|------------------|-------|
| 50617 | | | |
| Part no. | Socket | 6/11.1/12.1/0.9' | 1850g |
| 826 0607... 2224 | Content: 6-15° Offset star ratchet ring wrench E6xE7; E8xE10; E11xE12; E14xE16; E18xE20; E22xE24 | | |



6pc Double gear flat long wrench set

| | | | |
|-----------------|--|-------------------|-------|
| 50623 | | | |
| Part no. | Socket | 12/20.9/21.9/1.2' | 1740g |
| 827 1012...1719 | Content: 6-Double gear flat long wrench 10x12; 12x14; 13x15; 14x17; 16x18; 17x19 mm | | |



6pc Double gear flat wrench set

| | | | |
|----------------------|--|------------------|-------|
| K50625 | | | |
| Part no. | Socket | 6/15.5/16.5/0.8' | 2580g |
| 827M 0809... 1719 | Content: 6-Double gear flat wrench 8x9; 10x11; 12x13; 14x15; 16x18; 17x19 | | |



4pc Star double gear flat wrench set

| | | | |
|-----------------|---|-------------------|-------|
| K50411 | | | |
| Part no. | Socket | 12/15.0/16.0/1.1' | 1250g |
| 828 0608...2024 | Content: 4-Star double gear flat wrench E6xE8; E10xE12; E14xE18; E20xE24 | | |



34pc Tools set

| 5341 | | |
|-----------------|---|-------|
| Part no. | 3/15.6/16.6/1.7' | 5200g |
| Content: | | |
| 754 0607...1617 | 6-Double open end wrench 6x7; 8x9; 10x11; 12x13; 14x15; 16x17 mm | |
| 5102 | 10pc L key set | |
| 764 0127...10 | 1.27; 1.5; 2; 2.5; 3; 4; 5; 6; 8; 10 mm | |
| 711 0...2 | 3-Phillips screwdriver PH.0 (60mmL); PH.1 (80mmL); PH.2(100mmL) | |
| 713 03...065 | 5-Slotted screwdriver 3(75mmL); 3.5(100mmL); 4(100mmL); 5.5(125mmL); 6.5(150mmL) | |
| 613B250 | 1-Waterpump pliers 10" | |
| 610B160 | 1-Long nose pliers 6" | |
| 611B175 | 1-Combination pliers 7" | |
| 616300 | 1-Engineer hammer 300g | |
| 5096P803 | 1-Measuring tape 3m | |
| 649200A | 1-Adjustable gauged wrench 8" | |
| 5055P4 | 1-Utility knife (incl. 2pc blades) | |
| 6982 | 1-Technician's scissors | |
| 66303 | 1-Hacksaw | |
| 68601 | 1-LED white light, clip-type (360° rotation) | |



**Phillips anti-slip screwdriver
(Round steel)**

| 711 | | | | | |
|------------|------|-------|------|----|--------|
| Part no. | Tip | blade | over | g | pc/box |
| 7111S | PH.1 | 25 | 75 | 39 | 10 |
| 7112S | PH.2 | 25 | 75 | 42 | 10 |
| 7110 | PH.0 | 60 | 145 | 33 | 10 |
| 7111 | PH.1 | 80 | 185 | 79 | 10 |
| 7112 | PH.2 | 10 | 215 | 11 | 10 |



**Phillips anti-slip screwdriver
(Hexagon steel & Hexagon driver)**

| 7113 | | | | | |
|-------------|------|-------|------|-----|--------|
| Part no. | Tip | blade | over | g | pc/box |
| 7113 | PH.3 | 150 | 275 | 226 | 10 |



Hammer Phillips screwdriver

| 711..M | | | | | |
|---------------|------|-------|------|-----|--------|
| Part no. | Tip | blade | over | g | pc/box |
| 7111M | PH.1 | 80 | 185 | 96 | 10 |
| 7112M | PH.2 | 100 | 215 | 138 | 10 |
| 7113M | PH.3 | 150 | 275 | 231 | 10 |
| 7114M | PH.4 | 200 | 325 | 329 | 10 |
| 7113004M | PH.4 | 300 | 425 | 205 | 5 |



Insulated Phillips screwdriver

| 711..N | | | | | |
|---------------|------|-------|------|-----|--------|
| Part no. | Tip | blade | over | g | pc/box |
| 7110N | PH.0 | 60 | 145 | 34 | 10 |
| 7111N | PH.1 | 80 | 185 | 71 | 10 |
| 7112N | PH.2 | 100 | 215 | 102 | 10 |
| 7113N | PH.3 | 150 | 275 | 183 | 10 |



Hammer pozidriv screwdriver

| 712..M | | | | | |
|---------------|------|-------|------|-----|--------|
| Part no. | Tip | blade | over | g | pc/box |
| 7121M | PZ.1 | 80 | 185 | 88 | 10 |
| 7122M | PZ.2 | 100 | 215 | 138 | 10 |
| 7123M | PZ.3 | 150 | 275 | 231 | 10 |
| 7124M | PZ.4 | 200 | 325 | 316 | 10 |
| 7123004M | PZ.4 | 300 | 425 | 380 | 5 |



**Pozidriv anti-slip screwdriver
(Round steel)**

| 712 | | | | | |
|------------|------|-------|------|-----|--------|
| Part no. | Tip | blade | over | g | pc/box |
| 7121S | PZ.1 | 25 | 75 | 38 | 10 |
| 7122S | PZ.2 | 25 | 75 | 42 | 10 |
| 7120 | PZ.0 | 60 | 145 | 32 | 10 |
| 7121 | PZ.1 | 80 | 185 | 79 | 10 |
| 7122 | PZ.2 | 100 | 215 | 114 | 10 |

Insulated pozidriv screwdriver

| 712..N | | | | | |
|---------------|------|-------|------|-----|--------|
| Part no. | Tip | blade | over | g | pc/box |
| 7120N | PZ.0 | 60 | 145 | 30 | 10 |
| 7121N | PZ.1 | 80 | 185 | 66 | 10 |
| 7122N | PZ.2 | 100 | 215 | 96 | 10 |
| 7123N | PZ.3 | 150 | 275 | 185 | 10 |



**Slotted anti-slip screwdriver
(Round steel)**

| 713 | | | | | |
|------------|-----------|-------|------|-----|--------|
| Part no. | Tip | blade | over | g | pc/box |
| 713055S | 1.0 x 5.5 | 25 | 75 | 36 | 10 |
| 713065S | 1.2 x 6.5 | 25 | 75 | 40 | 10 |
| 71303 | 0.5 x 3 | 75 | 160 | 31 | 10 |
| 713035 | 0.5 x 3.5 | 100 | 185 | 35 | 10 |
| 71304 | 0.8 x 4 | 100 | 205 | 58 | 10 |
| 713055 | 1.0 x 5.5 | 125 | 230 | 65 | 10 |
| 713065 | 1.2 x 6.5 | 150 | 265 | 132 | 10 |

**Pozidriv anti-slip screwdriver
(Hexagon steel & Hexagon driver)**

| 7123 | | | | | |
|-------------|------|-------|------|-----|--------|
| Part no. | Tip | blade | over | g | pc/box |
| 7123 | PZ.3 | 150 | 275 | 197 | 10 |





Spline combination wrench

| 755..Q | | | | | | | <i>l</i> | | |
|----------|------|--------|---------|--------|--------|-----|----------|-----|--------|
| Part no. | size | 6point | 12point | SAE | E-Torx | XZN | mm | g | pc/box |
| 75506Q | M6 | • | • | | E8 | 6 | 105 | 17 | 10 |
| 75507Q | M7 | • | • | 9/32" | | 7 | 115 | 20 | 10 |
| 75508Q | M8 | • | • | 5/16" | E10 | 8 | 125 | 25 | 10 |
| 75509Q | M9 | • | • | 11/32" | E11 | 9 | 135 | 32 | 10 |
| 75510Q | M10 | • | • | 3/8" | E12 | 10 | 145 | 40 | 10 |
| 75511Q | M11 | • | • | 7/16" | E14 | 11 | 155 | 48 | 10 |
| 75512Q | M12 | • | • | 15/32" | | 12 | 165 | 58 | 10 |
| 75513Q | M13 | • | • | 1/2" | E16 | | 175 | 68 | 10 |
| 75514Q | M14 | • | • | 9/16" | E18 | 14 | 185 | 84 | 10 |
| 75515Q | M15 | • | • | 19/32" | | | 195 | 90 | 10 |
| 75516Q | M16 | • | • | 5/8" | E20 | 16 | 205 | 102 | 10 |
| 75517Q | M17 | • | • | | | | 215 | 122 | 10 |
| 75518Q | M18 | • | • | | E22 | 18 | 225 | 128 | 10 |
| 75519Q | M19 | • | • | 3/4" | E24 | | 235 | 154 | 5 |
| 75520Q | M20 | • | • | 25/32" | | 20 | 245 | 176 | 5 |
| 75521Q | M21 | • | • | 13/16" | | 22 | 255 | 208 | 5 |
| 75522Q | M22 | • | • | 7/8" | | | 265 | 234 | 5 |
| 75523Q | M23 | • | • | | | | 275 | 226 | 5 |
| 75524Q | M24 | • | • | 15/16" | | 24 | 285 | 286 | 5 |



Star 75° Offset wrench

| 756..A | | <i>l</i> | | |
|----------|---------|----------|-----|--------|
| Part no. | size | mm | g | pc/box |
| 7560608A | E6xE8 | 145 | 34 | 10 |
| 7560711A | E7xE11 | 155 | 42 | 10 |
| 7561012A | E10xE12 | 175 | 51 | 10 |
| 7561418A | E14xE18 | 215 | 112 | 10 |
| 7561622A | E16xE22 | 235 | 192 | 5 |
| 7562024A | E20xE24 | 265 | 224 | 5 |



Star hinged socket wrench

| 756...F | | <i>l</i> | | |
|----------|---------|----------|-----|--------|
| Part no. | size | mm | g | pc/box |
| 7560405F | E4xE5 | 198 | 83 | 10 |
| 7560607F | E6xE7 | 198 | 86 | 10 |
| 7560810F | E8xE10 | 198 | 88 | 10 |
| 7561112F | E11xE12 | 213 | 116 | 10 |
| 7561416F | E14xE16 | 227 | 175 | 10 |
| 7561820F | E18xE20 | 243 | 242 | 5 |
| 7562224F | E22xE24 | 277 | 424 | 5 |



Flat gear wrench

| 757 | | <i>l</i> | | |
|----------|--------|----------|-----|--------|
| Part no. | size | mm | g | pc/box |
| 75708 | 8 | 140 | 36 | 10 |
| 75709 | 9 | 150 | 46 | 10 |
| 75710 | 10 | 160 | 59 | 10 |
| 75711 | 11 | 165 | 69 | 10 |
| 75712 | 12 | 170 | 83 | 10 |
| 75713 | 13 | 180 | 99 | 10 |
| 75714 | 14 | 190 | 122 | 10 |
| 75715 | 15 | 200 | 132 | 10 |
| 75716 | 16 | 210 | 154 | 10 |
| 75717 | 17 | 223 | 181 | 10 |
| 75718 | 18 | 233 | 204 | 10 |
| 75719 | 19 | 244 | 241 | 10 |
| 75720 | 20 | 275 | 330 | 5 |
| 75721 | 21 | 275 | 330 | 5 |
| 75722 | 22 | 290 | 355 | 5 |
| 75723 | 23 | 290 | 355 | 5 |
| 75724 | 24 | 290 | 355 | 5 |
| 7575.16 | 5/16" | 140 | 36 | 10 |
| 7573.8 | 3/8" | 160 | 59 | 10 |
| 7577.16 | 7/16" | 165 | 69 | 10 |
| 7571.2 | 1/2" | 170 | 83 | 10 |
| 7579.16 | 9/16" | 190 | 122 | 10 |
| 7575.8 | 5/8" | 210 | 154 | 10 |
| 75711.16 | 11/16" | 223 | 181 | 10 |
| 7573.4 | 3/4" | 244 | 241 | 10 |
| 75713.16 | 13/16" | 275 | 355 | 5 |
| 7577.8 | 7/8" | 290 | 355 | 5 |
| 75715.16 | 15/16" | 290 | 355 | 5 |



Flexible gear wrench

| 757..F | | <i>l</i> | | |
|----------|------|----------|-----|--------|
| Part no. | size | mm | g | pc/box |
| 75708F | 8 | 130 | 50 | 10 |
| 75709F | 9 | 155 | 73 | 10 |
| 75710F | 10 | 155 | 73 | 10 |
| 75711F | 11 | 173 | 99 | 10 |
| 75712F | 12 | 173 | 99 | 10 |
| 75713F | 13 | 185 | 116 | 10 |
| 75714F | 14 | 191 | 133 | 10 |
| 75715F | 15 | 215 | 198 | 10 |
| 75716F | 16 | 215 | 198 | 10 |
| 75717F | 17 | 230 | 223 | 10 |
| 75718F | 18 | 248 | 276 | 10 |
| 75719F | 19 | 248 | 276 | 10 |

| 757...F | Size | <i>l</i> | | |
|-----------|--------|----------|-----|--------|
| Part no. | inch | mm | g | pc/box |
| 7575.16F | 5/16" | 135 | 47 | 10 |
| 7573.8F | 3/8" | 158 | 69 | 10 |
| 7577.16F | 7/16" | 175 | 100 | 10 |
| 7571.2F | 1/2" | 185 | 118 | 10 |
| 7579.16F | 9/16" | 195 | 129 | 10 |
| 7575.8F | 5/8" | 215 | 196 | 10 |
| 75711.16F | 11/16" | 228 | 216 | 10 |
| 7573.4F | 3/4" | 248 | 269 | 10 |
| 75713.16F | 13/16" | 280 | 458 | 10 |
| 7577.8F | 7/8" | 280 | 442 | 10 |
| 75715.16F | 15/16" | 310 | 545 | 10 |
| 7571.0F | 1" | 310 | 526 | 10 |



Reversible gear wrench

| 757..R | | <i>l</i> | | |
|-----------|--------|----------|-----|--------|
| Part no. | size | mm | g | pc/box |
| 75708R | 8 | 140 | 43 | 10 |
| 75709R | 9 | 150 | 51 | 10 |
| 75710R | 10 | 160 | 66 | 10 |
| 75711R | 11 | 165 | 72 | 10 |
| 75712R | 12 | 170 | 83 | 10 |
| 75713R | 13 | 180 | 106 | 10 |
| 75714R | 14 | 190 | 126 | 10 |
| 75715R | 15 | 200 | 142 | 10 |
| 75716R | 16 | 210 | 158 | 10 |
| 75717R | 17 | 223 | 196 | 10 |
| 75718R | 18 | 233 | 219 | 10 |
| 75719R | 19 | 244 | 263 | 10 |
| 75720R | 20 | 275 | 330 | 5 |
| 75721R | 21 | 275 | 330 | 5 |
| 75722R | 22 | 290 | 355 | 5 |
| 75723R | 23 | 290 | 355 | 5 |
| 75724R | 24 | 320 | 488 | 5 |
| 7575.16R | 5/16" | 140 | 43 | 10 |
| 7573.8R | 3/8" | 160 | 66 | 10 |
| 7577.16R | 7/16" | 165 | 72 | 10 |
| 7571.2R | 1/2" | 170 | 83 | 10 |
| 7579.16R | 9/16" | 190 | 126 | 10 |
| 7575.8R | 5/8" | 210 | 158 | 10 |
| 75711.16R | 11/16" | 223 | 196 | 10 |
| 7573.4R | 3/4" | 244 | 263 | 10 |
| 75713.16R | 13/16" | 275 | 330 | 5 |
| 7577.8R | 7/8" | 290 | 355 | 5 |
| 75715.16R | 15/16" | 290 | 355 | 5 |



Stubby flat gear wrench

| 757S | | l | | |
|----------|------|----------|-----|--------|
| Part no. | size | mm | g | pc/box |
| 757S08 | 8 | 92 | 29 | 10 |
| 757S09 | 9 | 92 | 43 | 10 |
| 757S10 | 10 | 94 | 43 | 10 |
| 757S11 | 11 | 105 | 59 | 10 |
| 757S12 | 12 | 105 | 59 | 10 |
| 757S13 | 13 | 105 | 65 | 10 |
| 757S14 | 14 | 115 | 89 | 10 |
| 757S15 | 15 | 120 | 117 | 10 |
| 757S16 | 16 | 120 | 117 | 10 |
| 757S17 | 17 | 125 | 122 | 10 |
| 757S18 | 18 | 138 | 167 | 10 |
| 757S19 | 19 | 138 | 167 | 10 |



45° Offset ring wrench

| 758 | | l | | |
|--------------------|-------|----------|-----|--------|
| Part no. | size | mm | g | pc/box |
| 7580507 NEW | 5x7 | 168 | 50 | 10 |
| 7580607 | 6x7 | 165 | 50 | 10 |
| 7580608 NEW | 6x8 | 165 | 55 | 10 |
| 7580709 | 7x9 | 175 | 55 | 10 |
| 7580809 | 8x9 | 175 | 60 | 10 |
| 7580810 | 8x10 | 185 | 63 | 10 |
| 7581011 | 10x11 | 195 | 88 | 10 |
| 7581012 | 10x12 | 195 | 90 | 10 |
| 7581013 NEW | 10x13 | 195 | 95 | 10 |
| 7581113 | 11x13 | 205 | 101 | 10 |
| 7581213 | 12x13 | 205 | 102 | 10 |
| 7581214 | 12x14 | 220 | 99 | 10 |
| 7581317 NEW | 13x17 | 235 | 240 | 10 |
| 7581415 | 14x15 | 230 | 138 | 10 |
| 7581417 | 14x17 | 240 | 177 | 10 |

| 758 | | l | | |
|--------------------|---------------|----------|-----|--------|
| Part no. | size | mm | g | pc/box |
| 7581516 | 15x16 | 240 | 180 | 5 |
| 7581617 | 16x17 | 240 | 184 | 5 |
| 7581618 | 16x18 | 240 | 191 | 5 |
| 7581619 | 16x19 | 240 | 200 | 5 |
| 7581719 | 17x19 | 250 | 200 | 5 |
| 7581721 NEW | 17x21 | 270 | 270 | 5 |
| 7581819 | 18x19 | 250 | 205 | 5 |
| 7581921 | 19x21 | 270 | 211 | 5 |
| 7581922 | 19x22 | 270 | 211 | 5 |
| 7581924 NEW | 19x24 | 290 | 320 | 5 |
| 7582022 | 20x22 | 270 | 283 | 5 |
| 7582122 | 21x22 | 290 | 283 | 5 |
| 7582123 | 21x23 | 290 | 283 | 5 |
| 7582224 | 22x24 | 320 | 355 | 5 |
| 7582126 NEW | 21x26 | 360 | 360 | 5 |
| 7582127 NEW | 21x27 | 360 | 360 | 5 |
| 7582326 | 23x26 | 360 | 470 | 5 |
| 7582426 | 24x26 | 360 | 470 | 5 |
| 7582427 | 24x27 | 360 | 503 | 5 |
| 7582430 NEW | 24x30 | 372 | 360 | 5 |
| 7582528 NEW | 25x28 | 372 | 360 | 5 |
| 7582732 | 27x32 | 360 | 610 | 5 |
| 7583032 | 30x32 | 360 | 747 | 5 |
| 7580608S | 1/4"x5/16" | 163 | 54 | 10 |
| 7580810S | 5/16"x3/8" | 183 | 63 | 10 |
| 7581011S | 3/8"x7/16" | 198 | 88 | 10 |
| 7581113S | 7/16"x1/2" | 205 | 101 | 10 |
| 7581314S | 1/2"x9/16" | 220 | 102 | 10 |
| 7581416S | 9/16"x5/8" | 230 | 177 | 10 |
| 7581617S | 5/8"x11/16" | 240 | 180 | 5 |
| 7581619S | 5/8"x3/4" | 250 | 200 | 5 |
| 7581719S | 11/16"x3/4" | 250 | 208 | 5 |
| 7581922S | 3/4"x7/8" | 270 | 210 | 5 |
| 7582122S | 13/16"x7/8" | 290 | 283 | 5 |
| 7582224S | 7/8"x15/16" | 320 | 355 | 5 |
| 7582425S | 15/16"x1" | 360 | 355 | 5 |
| 7582527S | 1"x1-1/16" | 360 | 355 | 5 |
| 7582932S | 1-1/8"x1-1/4" | 360 | 610 | 5 |



Midget 45° offset ring wrench

| 758S | | l | | |
|-----------|------------|----------|-----|--------|
| Part no. | size | mm | g | pc/box |
| 758S0708 | 7x8 | 115 | 46 | 10 |
| 758S0809 | 8x9 | 115 | 46 | 10 |
| 758S0810 | 8x10 | 115 | 46 | 10 |
| 758S1011 | 10x11 | 115 | 46 | 10 |
| 758S1012 | 10x12 | 115 | 46 | 10 |
| 758S1213 | 12x13 | 140 | 86 | 10 |
| 758S1214 | 12x14 | 140 | 86 | 10 |
| 758S1314 | 13x14 | 140 | 86 | 10 |
| 758S1415 | 14x15 | 140 | 86 | 10 |
| 758S1417 | 14x17 | 157 | 134 | 10 |
| 758S1617 | 16x17 | 157 | 134 | 10 |
| 758S1618 | 16x18 | 157 | 134 | 10 |
| 758S1619 | 16x19 | 157 | 134 | 10 |
| 758S1719 | 17x19 | 157 | 134 | 10 |
| 758S1819 | 18x19 | 157 | 134 | 10 |
| 758S1011S | 3/8"x7/16" | 115 | 46 | 10 |
| 758S1314S | 1/2"x9/16" | 140 | 86 | 10 |
| 758S1619S | 5/8"x3/4" | 157 | 134 | 10 |



75° Offset ring wrench

| 759 | | l | | |
|--------------------|-------|----------|-----|--------|
| Part no. | size | mm | g | pc/box |
| 7590607 | 6x7 | 168 | 53 | 10 |
| 7590608 | 6x8 | 168 | 46 | 10 |
| 7590709 NEW | 7x9 | 183 | 50 | 10 |
| 7590809 | 8x9 | 183 | 64 | 10 |
| 7590810 | 8x10 | 183 | 64 | 10 |
| 7591011 | 10x11 | 198 | 100 | 10 |
| 7591012 | 10x12 | 198 | 101 | 10 |
| 7591213 | 12x13 | 217 | 132 | 10 |
| 7591214 | 12x14 | 217 | 135 | 10 |
| 7591314 NEW | 13x14 | 217 | 135 | 10 |
| 7591315 | 13x15 | 239 | 150 | 10 |
| 7591317 NEW | 13x17 | 260 | 200 | 10 |
| 7591415 | 14x15 | 239 | 161 | 10 |
| 7591417 | 14x17 | 260 | 207 | 10 |
| 7591617 | 16x17 | 260 | 206 | 10 |
| 7591618 | 16x18 | 260 | 203 | 10 |
| 7591719 | 17x19 | 292 | 257 | 5 |
| 7591819 | 18x19 | 292 | 258 | 5 |

| 759 | | l | | |
|---------------------|----------------|----------|------|--------|
| Part no. | size | mm | g | pc/box |
| 7591921 | 19x21 | 300 | 311 | 5 |
| 7591922 NEW | 19x22 | 318 | 319 | 5 |
| 7592022 | 20x22 | 318 | 319 | 5 |
| 7592122 | 21x22 | 318 | 319 | 5 |
| 7592123 | 21x23 | 327 | 388 | 5 |
| 7592224 | 22x24 | 327 | 358 | 5 |
| 7592326 | 23x26 | 329 | 489 | 5 |
| 7592426 | 24x26 | 329 | 492 | 5 |
| 7592427 | 24x27 | 329 | 496 | 5 |
| 7592526 | 25x26 | 329 | 496 | 5 |
| 7592528 | 25x28 | 347 | 536 | 5 |
| 7592627 | 26x27 | 347 | 522 | 5 |
| 7592628 | 26x28 | 347 | 534 | 5 |
| 7592730 NEW | 27x30 | 355 | 573 | 5 |
| 7592732 | 27x32 | 355 | 612 | 5 |
| 7593032 | 30x32 | 362 | 664 | 5 |
| 7593236 | 32x36 | 415 | 905 | 5 |
| 7593436 | 34x36 | 415 | 908 | 5 |
| 7593641 | 36x41 | 450 | 1141 | 5 |
| 7594146 NEW | 41x46 | 506 | 1500 | 5 |
| 7594650 NEW | 46x50 | 526 | 1650 | 5 |
| 7590608S | 1/4"x5/16" | 168 | 47 | 10 |
| 7590810S NEW | 5/16"x3/8" | 183 | 100 | 10 |
| 7591011S | 3/8"x7/16" | 198 | 91 | 10 |
| 7591314S | 1/2"x9/16" | 239 | 131 | 10 |
| 7591416S NEW | 9/16"x5/8" | 239 | 207 | 10 |
| 7591617S | 5/8"x11/16" | 260 | 188 | 10 |
| 7591619S | 5/8"x3/4" | 292 | 193 | 10 |
| 7591719S NEW | 11/16"x3/4" | 292 | 257 | 10 |
| 7591922S | 3/4"x7/8" | 300 | 309 | 5 |
| 7592122S | 13/16"x7/8" | 318 | 310 | 5 |
| 7592224S | 7/8"x15/16" | 326 | 372 | 5 |
| 7592425S | 15/16"x1" | 329 | 496 | 5 |
| 7592427S NEW | 15/16"x1-1/16" | 329 | 496 | 5 |
| 7592529S | 1"x1-1/8" | 347 | 458 | 5 |
| 7592729S | 1-1/16"x1-1/8" | 347 | 540 | 5 |
| 7592732S | 1-1/16"x1-1/4" | 355 | 651 | 5 |
| 7592932S | 1-1/8"x1-1/4" | 362 | 616 | 5 |



Extra-long offset ring wrench

| 760 | | l | | |
|--------------------|-------|----------|-----|--------|
| Part no. | Size | mm | g | pc/box |
| 7600810 | 8x10 | 240 | 87 | 10 |
| 7601012 | 10x12 | 290 | 124 | 10 |
| 7601214 | 12x14 | 330 | 200 | 10 |
| 7601315 | 13x15 | 360 | 333 | 10 |
| 7601417 | 14x17 | 370 | 333 | 10 |
| 7601618 | 16x18 | 405 | 458 | 10 |
| 7601719 | 17x19 | 405 | 447 | 10 |
| 7602123 NEW | 21x23 | 440 | 660 | 10 |
| 7602224 | 22x24 | 440 | 602 | 10 |

NEW



Double ring wrench (15 degree bowed)

| 760...A | size | <i>l</i> | | |
|----------------|-------|----------|-----|--------|
| Part no. | mm | mm | g | pc/box |
| 7600607A | 6x7 | 120 | 22 | 10 |
| 7600809A | 8x9 | 136 | 32 | 10 |
| 7601011A | 10x11 | 155 | 47 | 10 |
| 7601213A | 12x13 | 163 | 64 | 10 |
| 7601415A | 14x15 | 177 | 91 | 10 |
| 7601617A | 16x17 | 210 | 118 | 10 |
| 7601819A | 18x19 | 225 | 144 | 10 |
| 7602022A | 20x22 | 240 | 190 | 10 |
| 7602123A | 21x23 | 258 | 239 | 5 |
| 7602224A | 22x24 | 255 | 234 | 5 |
| 7602628A | 26x28 | 320 | 435 | 5 |
| 7602729A | 27x29 | 315 | 419 | 5 |
| 7603032A | 30x32 | 335 | 517 | 5 |

NEW



Flat ring wrench (0 degree offset)

| 760M | size | <i>l</i> | | |
|-------------|-------|----------|-----|--------|
| Part no. | mm | mm | g | pc/box |
| 760M0607 | 6x7 | 120 | 23 | 10 |
| 760M0809 | 8x9 | 135 | 31 | 10 |
| 760M1011 | 10x11 | 153 | 48 | 10 |
| 760M1213 | 12x13 | 162 | 64 | 10 |
| 760M1415 | 14x15 | 180 | 92 | 10 |
| 760M1617 | 16x17 | 210 | 118 | 10 |
| 760M1819 | 18x19 | 225 | 146 | 10 |
| 760M2022 | 20x22 | 240 | 186 | 10 |
| 760M2123 | 21x23 | 255 | 245 | 5 |
| 760M2224 | 22x24 | 255 | 224 | 5 |
| 760M2628 | 26x28 | 313 | 417 | 5 |
| 760M2729 | 27x29 | 315 | 414 | 5 |
| 760M3032 | 30x32 | 335 | 510 | 5 |



Half-moon ring wrench

| 761 | | <i>l</i> | | |
|--------------------|-------|----------|-----|--------|
| Part no. | size | mm | g | pc/box |
| 7610810 | 8x10 | 141 | 56 | 10 |
| 7611012 | 10x12 | 141 | 65 | 10 |
| 7611113 | 11x13 | 166 | 104 | 10 |
| 7611214 | 12x14 | 166 | 93 | 10 |
| 7611315 | 13x15 | 190 | 134 | 10 |
| 7611417 | 14x17 | 190 | 141 | 10 |
| 7611618 | 16x18 | 220 | 190 | 10 |
| 7611719 | 17x19 | 220 | 190 | 10 |
| 7611922 | 19x22 | 256 | 240 | 5 |
| 7612224 NEW | 22x24 | 292 | 410 | 5 |



S-form ring wrench

| 761...A | | <i>l</i> | | |
|----------------|-------------|----------|-----|--------|
| Part no. | size | mm | g | pc/box |
| 7611012A | 10x12 | 142 | 56 | 10 |
| 7611113A | 11x13 | 155 | 56 | 10 |
| 7611415A | 14x15 | 188 | 100 | 10 |
| 7611618A | 16x18 | 225 | 164 | 10 |
| 7611719A | 17x19 | 237 | 198 | 5 |
| 7612224A | 22x24 | 270 | 296 | 5 |
| 7611113AS | 7/16"x1/2" | 142 | 56 | 10 |
| 7611415AS | 9/16"x5/8" | 188 | 100 | 10 |
| 7611719AS | 11/16"x3/4" | 237 | 198 | 5 |
| 7612224AS | 7/8"x15/16" | 270 | 296 | 5 |



Double ended 6pt.-6pt. socket wrench

| 762 | | <i>l</i> | | |
|--------------------|-------|----------|-----|--------|
| Part no. | size | mm | g | pc/box |
| 7620607 | 6x7 | 117 | 32 | 10 |
| 7620809 | 8x9 | 123 | 48 | 10 |
| 7620810 NEW | 8x10 | 123 | 52 | 10 |
| 7621011 | 10x11 | 131 | 66 | 10 |
| 7621213 | 12x13 | 144 | 106 | 10 |
| 7621214 NEW | 12x14 | 148 | 122 | 10 |
| 7621415 | 14x15 | 153 | 138 | 10 |
| 7621617 | 16x17 | 162 | 188 | 10 |
| 7621819 | 18x19 | 175 | 238 | 10 |
| 7622022 | 20x22 | 185 | 262 | 5 |
| 7622123 | 21x23 | 185 | 294 | 5 |
| 7622426 | 24x26 | 193 | 416 | 5 |
| 7622427 NEW | 24x27 | 195 | 429 | 5 |
| 7622528 | 25x28 | 196 | 442 | 5 |
| 7622729 | 27x29 | 200 | 504 | 5 |
| 7623032 | 30x32 | 202 | 630 | 5 |



Bar for double ended socket wrench

| 762.. | <i>l</i> | | |
|--------------|----------|-----|--------|
| Part no. | mm | g | pc/box |
| 762220 | 220 | 105 | 10 |
| 762300 | 300 | 280 | 10 |

*762220 only for 7620607 - 7622123 use
*762300 only for 7622426 - 7623032 use



Hex key

| 764 | | <i>l</i> | <i>l</i> | | |
|------------|------|----------|----------|----|--------|
| Part no. | Tip | short | long | g | pc/bag |
| 7640127 | 1.27 | 12 | 40 | 2 | 10 |
| 764015 | 1.5 | 14 | 45 | 2 | 10 |
| 76402 | 2 | 16 | 50 | 2 | 10 |
| 764025 | 2.5 | 18 | 56 | 4 | 10 |
| 76403 | 3 | 20 | 63 | 6 | 10 |
| 764035 | 3.5 | 22 | 66 | 6 | 10 |
| 76404 | 4 | 25 | 70 | 10 | 10 |

| 764 | | <i>l</i> | <i>l</i> | | |
|--------------------|-------|----------|----------|------|--------|
| Part no. | Tip | short | long | g | pc/bag |
| 764045 | 4.5 | 26 | 76 | 10 | 10 |
| 76405 | 5 | 28 | 80 | 20 | 10 |
| 764055 | 5.5 | 30 | 85 | 24 | 10 |
| 76406 | 6 | 32 | 90 | 30 | 10 |
| 76407 | 7 | 34 | 95 | 44 | 10 |
| 76408 | 8 | 36 | 100 | 60 | 10 |
| 76409 | 9 | 38 | 105 | 90 | 10 |
| 76410 | 10 | 40 | 112 | 105 | 10 |
| 76411 | 11 | 42 | 118 | 140 | 5 |
| 76412 | 12 | 45 | 125 | 183 | 5 |
| 76413 | 13 | 50 | 132 | 207 | 5 |
| 76414 | 14 | 56 | 140 | 292 | 5 |
| 76416 | 16 | 60 | 150 | 390 | 5 |
| 76417 | 17 | 63 | 160 | 527 | 5 |
| 76419 | 19 | 70 | 180 | 674 | 5 |
| 76421 NEW | 21 | 78 | 190 | 820 | 5 |
| 76422 | 22 | 80 | 200 | 991 | 5 |
| 76423 NEW | 23 | 85 | 210 | 1200 | 5 |
| 76424 | 24 | 90 | 224 | 1344 | 5 |
| 76426 NEW | 26 | 97 | 230 | 1500 | 5 |
| 76427 | 27 | 100 | 250 | 1770 | 5 |
| 76430 | 30 | 112 | 285 | 2372 | 5 |
| 76432 | 32 | 125 | 315 | 3162 | 5 |
| 76436 | 36 | 140 | 355 | 4475 | 4 |
| 7641.16 | 1/16" | 14 | 45 | 1 | 10 |
| 7645.64 | 5/64" | 16 | 50 | 2 | 10 |
| 7643.32 | 3/32" | 18 | 56 | 3 | 10 |
| 7647.64 NEW | 7/64" | 19 | 59 | 4 | 10 |
| 7641.8 | 1/8" | 20 | 63 | 6 | 10 |
| 7649.64 NEW | 9/64" | 22 | 65 | 8 | 10 |
| 7645.32 | 5/32" | 25 | 70 | 10 | 10 |
| 7643.16 | 3/16" | 28 | 80 | 17 | 10 |
| 7647.32 NEW | 7/32" | 30 | 85 | 24 | 10 |
| 7641.4 | 1/4" | 32 | 90 | 34 | 10 |
| 7649.32 NEW | 9/32" | 34 | 95 | 43 | 10 |
| 7645.16 | 5/16" | 36 | 100 | 59 | 10 |
| 7643.8 | 3/8" | 40 | 112 | 97 | 10 |
| 7647.16 | 7/16" | 45 | 125 | 153 | 10 |
| 7641.2 | 1/2" | 50 | 132 | 219 | 5 |
| 7649.16 | 9/16" | 55 | 140 | 303 | 5 |
| 7645.8 | 5/8" | 60 | 160 | 402 | 5 |
| 7643.4 | 3/4" | 70 | 180 | 640 | 5 |
| 7647.8 | 7/8" | 80 | 220 | 1024 | 5 |
| 7641.0 | 1" | 90 | 224 | 1366 | 5 |



Hex long key

| 764..L | | | | | |
|-----------------------------|-------|-------|------|------|--------|
| Part no. | Tip | short | long | g | pc/bag |
| 7640127L | 1.27 | 12 | 68 | 4 | 10 |
| 764015L | 1.5 | 14 | 77 | 4 | 10 |
| 76402L | 2 | 16 | 83 | 4 | 10 |
| 764025L | 2.5 | 18 | 90 | 6 | 10 |
| 76403L | 3 | 20 | 98 | 8 | 10 |
| 764035L | 3.5 | 22 | 102 | 12 | 10 |
| 76404L | 4 | 25 | 106 | 14 | 10 |
| 764045L | 4.5 | 26 | 112 | 20 | 10 |
| 76405L | 5 | 28 | 118 | 25 | 10 |
| 764055L | 5.5 | 30 | 128 | 34 | 10 |
| 76406L | 6 | 32 | 138 | 41 | 10 |
| 76407L | 7 | 34 | 147 | 68 | 10 |
| 76408L | 8 | 36 | 156 | 84 | 10 |
| 76409L <small>NEW</small> | 9 | 38 | 160 | 114 | 10 |
| 76410L | 10 | 40 | 170 | 144 | 10 |
| 76411L | 11 | 42 | 190 | 188 | 5 |
| 76412L | 12 | 45 | 205 | 299 | 5 |
| 76413L | 13 | 50 | 215 | 388 | 5 |
| 76414L | 14 | 56 | 230 | 460 | 5 |
| 76417L | 17 | 63 | 250 | 779 | 5 |
| 76419L | 19 | 70 | 280 | 1096 | 5 |
| 7641.16L | 1/16" | 14 | 77 | 4 | 10 |
| 7645.64L | 5/64" | 16 | 83 | 4 | 10 |
| 7643.32L | 3/32" | 18 | 90 | 6 | 10 |
| 7641.8L | 1/8" | 20 | 98 | 8 | 10 |
| 7645.32L | 5/32" | 25 | 106 | 14 | 10 |
| 7643.16L | 3/16" | 28 | 118 | 25 | 10 |
| 7647.32L <small>NEW</small> | 7/32" | 30 | 128 | 34 | 10 |
| 7641.4L | 1/4" | 32 | 136 | 41 | 10 |
| 7649.32L <small>NEW</small> | 9/32" | 34 | 147 | 50 | 10 |
| 7645.16L | 5/16" | 36 | 156 | 84 | 10 |
| 7643.8L | 3/8" | 40 | 170 | 142 | 10 |
| 7641.2L | 1/2" | 45 | 207 | 250 | 5 |
| 7649.16L | 9/16" | 56 | 230 | 355 | 5 |
| 7645.8L | 5/8" | 63 | 250 | 550 | 5 |
| 7643.4L | 3/4" | 70 | 290 | 810 | 5 |
| 7647.8L <small>NEW</small> | 7/8" | 85 | 350 | 1200 | 5 |



Hex extra long key

| 764..XL | | | | | |
|------------------------------|-------|-------|------|------|--------|
| Part no. | Tip | short | long | g | pc/bag |
| 7640127XL | 1.27 | 12 | 80 | 4 | 10 |
| 764015XL | 1.5 | 14 | 90 | 4 | 10 |
| 76402XL | 2 | 16 | 100 | 6 | 10 |
| 764025XL | 2.5 | 18 | 112 | 6 | 10 |
| 76403XL | 3 | 20 | 126 | 10 | 10 |
| 764035XL | 3.5 | 22 | 132 | 12 | 10 |
| 76404XL | 4 | 25 | 140 | 18 | 10 |
| 764045XL | 4.5 | 26 | 150 | 24 | 10 |
| 76405XL | 5 | 28 | 160 | 33 | 10 |
| 764055XL | 5.5 | 30 | 170 | 41 | 10 |
| 76406XL | 6 | 32 | 180 | 53 | 10 |
| 76407XL | 7 | 34 | 190 | 75 | 10 |
| 76408XL | 8 | 36 | 200 | 103 | 10 |
| 76409XL | 9 | 38 | 210 | 137 | 10 |
| 76410XL | 10 | 40 | 224 | 180 | 10 |
| 76411XL | 11 | 42 | 240 | 230 | 10 |
| 76412XL | 12 | 45 | 250 | 300 | 5 |
| 76413XL | 13 | 50 | 260 | 356 | 5 |
| 76414XL | 14 | 56 | 280 | 452 | 5 |
| 76416XL | 16 | 60 | 300 | 627 | 5 |
| 76417XL | 17 | 63 | 320 | 784 | 5 |
| 76419XL | 19 | 70 | 360 | 1095 | 5 |
| 7641.16XL | 1/16" | 14 | 90 | 4 | 10 |
| 7645.64XL | 5/64" | 16 | 100 | 4 | 10 |
| 7643.32XL | 3/32" | 18 | 112 | 6 | 10 |
| 7647.64XL <small>NEW</small> | 7/64" | 19 | 118 | 8 | 10 |
| 7641.8XL | 1/8" | 20 | 126 | 10 | 10 |
| 7649.64XL <small>NEW</small> | 9/64" | 23 | 132 | 13 | 10 |
| 7645.32XL | 5/32" | 25 | 140 | 18 | 10 |
| 7643.16XL | 3/16" | 28 | 160 | 32 | 10 |
| 7647.32XL <small>NEW</small> | 7/32" | 30 | 170 | 41 | 10 |
| 7641.4XL | 1/4" | 32 | 180 | 52 | 10 |
| 7645.16XL | 5/16" | 36 | 200 | 104 | 10 |
| 7643.8XL | 3/8" | 40 | 224 | 175 | 10 |
| 7647.16XL | 7/16" | 42 | 236 | 230 | 10 |
| 7641.2XL | 1/2" | 45 | 250 | 356 | 5 |
| 7649.16XL <small>NEW</small> | 9/16" | 56 | 280 | 450 | 5 |
| 7645.8XL | 5/8" | 63 | 320 | 625 | 5 |
| 7643.4XL <small>NEW</small> | 3/4" | 70 | 360 | 750 | 5 |



T-shape hex key

| 764..T | | | | | |
|----------|-----|-------|-------|-----|--------|
| Part no. | Tip | blade | width | g | pc/box |
| 76402T | 2 | 62 | 125 | 34 | 10 |
| 764025T | 2.5 | 62 | 125 | 34 | 10 |
| 76403T | 3 | 75 | 150 | 41 | 10 |
| 764035T | 3.5 | 75 | 150 | 42 | 10 |
| 76404T | 4 | 90 | 180 | 60 | 10 |
| 764045T | 4.5 | 90 | 180 | 69 | 10 |
| 76405T | 5 | 90 | 180 | 69 | 10 |
| 76406T | 6 | 105 | 210 | 124 | 10 |
| 76407T | 7 | 105 | 210 | 133 | 10 |
| 76408T | 8 | 125 | 250 | 219 | 10 |
| 76409T | 9 | 140 | 280 | 366 | 10 |
| 76410T | 10 | 150 | 300 | 405 | 5 |
| 76412T | 12 | 160 | 320 | 552 | 5 |
| 76414T | 14 | 170 | 340 | 798 | 5 |

NEW

Adjustable T-shaped hex key

| 764...TA | | | | | |
|----------|-----|-----------|-----------|-----|--------|
| Part no. | Tip | blade(mm) | width(mm) | g | pc/box |
| 76402TA | 2 | 62 | 120 | 22 | 10 |
| 764025TA | 2.5 | 61 | 125 | 22 | 10 |
| 76403TA | 3 | 75 | 125 | 24 | 10 |
| 76404TA | 4 | 90 | 180 | 60 | 10 |
| 76405TA | 5 | 90 | 180 | 64 | 10 |
| 76406TA | 6 | 106 | 210 | 127 | 10 |
| 76408TA | 8 | 125 | 250 | 208 | 10 |
| 76410TA | 10 | 150 | 300 | 388 | 5 |
| 76412TA | 12 | 160 | 320 | 566 | 5 |
| 76414TA | 14 | 170 | 340 | 803 | 5 |

Hex ball point long key

| 765..L | | | | | | |
|----------------------------|-------|-------|------|-----|--------|--|
| Part no. | Tip | short | long | g | pc/bag | |
| 7650127L | 1.27 | 12 | 68 | 4 | 10 | |
| 765015L | 1.5 | 14 | 77 | 4 | 10 | |
| 76502L | 2 | 16 | 83 | 4 | 10 | |
| 765025L | 2.5 | 18 | 90 | 6 | 10 | |
| 76503L | 3 | 20 | 98 | 8 | 10 | |
| 765035L <small>NEW</small> | 3.5 | 22 | 102 | 10 | 10 | |
| 76504L | 4 | 25 | 106 | 14 | 10 | |
| 76505L | 5 | 28 | 120 | 26 | 10 | |
| 76506L | 6 | 32 | 137 | 42 | 10 | |
| 76507L | 7 | 34 | 147 | 68 | 10 | |
| 76508L | 8 | 36 | 156 | 84 | 10 | |
| 76510L | 10 | 40 | 170 | 146 | 10 | |
| 76512L | 12 | 45 | 205 | 230 | 5 | |
| 76514L | 14 | 56 | 230 | 355 | 5 | |
| 7651.16L | 1/16" | 14 | 77 | 4 | 10 | |
| 7655.64L | 5/64" | 16 | 83 | 4 | 10 | |
| 7653.32L | 3/32" | 18 | 90 | 6 | 10 | |
| 7651.8L | 1/8" | 20 | 98 | 8 | 10 | |
| 7655.32L | 5/32" | 25 | 106 | 14 | 10 | |
| 7653.16L | 3/16" | 28 | 118 | 26 | 10 | |
| 7657.32L | 7/32" | 30 | 128 | 38 | 10 | |
| 7651.4L | 1/4" | 32 | 137 | 42 | 10 | |
| 7655.16L | 5/16" | 36 | 156 | 84 | 10 | |
| 7653.8L | 3/8" | 40 | 170 | 142 | 10 | |
| 7651.2L | 1/2" | 45 | 207 | 250 | 5 | |
| 7659.16L | 9/16" | 56 | 230 | 335 | 5 | |

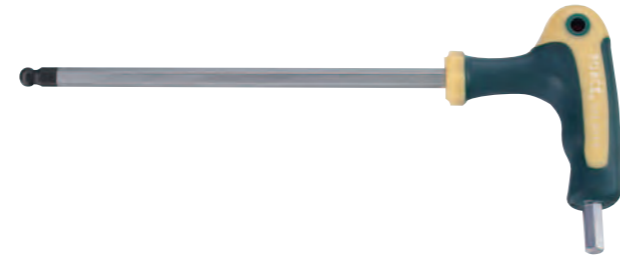

Hex ball point extra long key

| 765..XL | | | | | | |
|-------------------------|-------|-------|------|------|--------|--|
| Part no. | Tip | short | long | g | pc/bag | |
| 7650127XL | 1.27 | 12 | 80 | 4 | 10 | |
| 765015XL | 1.5 | 14 | 90 | 4 | 10 | |
| 76502XL | 2 | 16 | 100 | 6 | 10 | |
| 765025XL | 2.5 | 18 | 112 | 6 | 10 | |
| 76503XL | 3 | 20 | 126 | 9 | 10 | |
| 76504XL | 4 | 25 | 140 | 18 | 10 | |
| 76505XL | 5 | 28 | 160 | 32 | 10 | |
| 76506XL | 6 | 32 | 180 | 52 | 10 | |
| 76507XL ^{NEW} | 7 | 34 | 190 | 73 | 10 | |
| 76508XL | 8 | 36 | 200 | 107 | 10 | |
| 76510XL | 10 | 40 | 224 | 177 | 10 | |
| 76512XL ^{NEW} | 12 | 45 | 250 | 300 | 5 | |
| 76514XL ^{NEW} | 14 | 56 | 280 | 450 | 5 | |
| 76517XL ^{NEW} | 17 | 63 | 320 | 760 | 5 | |
| 76519XL ^{NEW} | 19 | 70 | 360 | 1075 | 5 | |
| 7651.16XL | 1/16" | 14 | 90 | 4 | 10 | |
| 7655.64XL | 5/64" | 16 | 100 | 4 | 10 | |
| 7653.32XL | 3/32" | 18 | 112 | 6 | 10 | |
| 7651.8XL | 1/8" | 20 | 126 | 10 | 10 | |
| 7655.32XL | 5/32" | 25 | 140 | 18 | 10 | |
| 7653.16XL | 3/16" | 28 | 160 | 32 | 10 | |
| 7651.4XL | 1/4" | 32 | 180 | 52 | 10 | |
| 7655.16XL | 5/16" | 36 | 200 | 104 | 10 | |
| 7653.8XL | 3/8" | 40 | 224 | 175 | 10 | |
| 7651.2XL ^{NEW} | 1/2" | 45 | 250 | 294 | 10 | |

Hex ball point grip key

| 765..G | | | | | | |
|-------------------------|-------|------|-------|-----|--------|--|
| Part no. | Tip | long | short | g | pc/box | |
| 76502G | 2 | 126 | 53 | 15 | 10 | |
| 765025G | 2.5 | 126 | 53 | 18 | 10 | |
| 76503G | 3 | 126 | 53 | 21 | 10 | |
| 76504G | 4 | 183 | 68 | 34 | 10 | |
| 76505G | 5 | 183 | 68 | 72 | 10 | |
| 76506G | 6 | 240 | 82 | 90 | 10 | |
| 76507G | 7 | 240 | 82 | 110 | 10 | |
| 76508G | 8 | 240 | 82 | 154 | 10 | |
| 76510G | 10 | 240 | 82 | 275 | 10 | |
| 76512G | 12 | 240 | 82 | 369 | 10 | |
| 7655.64G ^{NEW} | 5/64" | 126 | 53 | 15 | 10 | |
| 7653.32G | 3/32" | 126 | 53 | 17 | 10 | |
| 7651.8G | 1/8" | 183 | 68 | 22 | 10 | |
| 7655.32G | 5/32" | 183 | 68 | 34 | 10 | |
| 7653.16G | 3/16" | 240 | 82 | 67 | 10 | |
| 7651.4G | 1/4" | 240 | 82 | 95 | 10 | |
| 7655.16G | 5/16" | 240 | 82 | 152 | 10 | |
| 7653.8G | 3/8" | 240 | 82 | 254 | 10 | |
| 7651.2G | 1/2" | 240 | 82 | 406 | 10 | |



Star tamperproof grip key

| 767..G | | | | | | |
|----------|-----------|-------|------|-----|--------|--|
| Part no. | Tip | short | long | g | pc/box | |
| 76710G | T10xT-10H | 53 | 126 | 27 | 10 | |
| 76715G | T15xT-15H | 53 | 126 | 27 | 10 | |
| 76720G | T20xT-20H | 68 | 126 | 27 | 10 | |
| 76725G | T25xT-25H | 68 | 133 | 84 | 10 | |
| 76727G | T27xT-27H | 68 | 133 | 84 | 10 | |
| 76730G | T30xT-30H | 82 | 190 | 85 | 10 | |
| 76740G | T40xT-40H | 82 | 190 | 144 | 10 | |
| 76745G | T45xT-45H | 82 | 190 | 144 | 10 | |
| 76750G | T50xT-50H | 82 | 190 | 334 | 10 | |
| 76755G | T55xT-55H | 82 | 190 | 340 | 10 | |

Star key

| 766 | | | | | | |
|----------------------|-----|-------|-------|-----|--------|--|
| Part no. | Tip | short | long | g | pc/bag | |
| 76606 | T6 | 18 | 64 | 5 | 10 | |
| 76607 | T7 | 19 | 70 | 5 | 10 | |
| 76608 | T8 | 20 | 72 | 6 | 10 | |
| 76609 | T9 | 21 | 75 | 6 | 10 | |
| 76610 | T10 | 21 | 81 | 6 | 10 | |
| 76615 | T15 | 23 | 85 | 11 | 10 | |
| 76620 | T20 | 24 | 89 | 11 | 10 | |
| 76625 | T25 | 24 | 95 | 11 | 10 | |
| 76627 | T27 | 25 | 100 | 13 | 10 | |
| 76630 | T30 | 28 | 112.5 | 22 | 10 | |
| 76640 | T40 | 30 | 119 | 31 | 10 | |
| 76645 | T45 | 31 | 128 | 43 | 10 | |
| 76647 ^{NEW} | T47 | 32 | 135 | 58 | 10 | |
| 76650 | T50 | 34 | 148 | 59 | 10 | |
| 76655 | T55 | 37 | 168 | 107 | 10 | |
| 76660 | T60 | 39 | 185 | 177 | 5 | |
| 76670 | T70 | 43 | 200 | 261 | 5 | |
| 76680 | T80 | 45 | 213 | 370 | 5 | |

Star long key

| 766..L | | | | | | |
|-----------------------|-----|-------|------|-----|--------|--|
| Part no. | Tip | short | long | g | pc/bag | |
| 76606L | T6 | 18 | 68 | 5 | 10 | |
| 76607L | T7 | 18 | 73 | 6 | 10 | |
| 76608L | T8 | 18 | 77 | 6 | 10 | |
| 76609L | T9 | 18 | 82 | 6 | 10 | |
| 76610L | T10 | 19 | 86 | 6 | 10 | |
| 76615L | T15 | 21 | 90 | 8 | 10 | |
| 76620L | T20 | 23 | 95 | 11 | 10 | |
| 76625L | T25 | 25 | 98 | 18 | 10 | |
| 76627L | T27 | 26 | 105 | 19 | 10 | |
| 76630L | T30 | 29 | 115 | 30 | 10 | |
| 76635L ^{NEW} | T35 | 31 | 119 | 43 | 10 | |
| 76640L | T40 | 33 | 122 | 45 | 10 | |
| 76645L | T45 | 36 | 138 | 62 | 10 | |
| 76650L | T50 | 40 | 155 | 90 | 10 | |
| 76655L | T55 | 45 | 172 | 164 | 10 | |
| 76660L | T60 | 52 | 200 | 267 | 5 | |

Star tamperproof key

| 767 | | | | | | |
|----------------------|-------|-------|------|-----|--------|--|
| Part no. | Tip | short | long | g | pc/bag | |
| 76706 | T-6H | 18 | 50 | 3 | 10 | |
| 76707 | T-7H | 18 | 50 | 3 | 10 | |
| 76708 | T-8H | 18 | 50 | 3 | 10 | |
| 76709 | T-9H | 18 | 50 | 4 | 10 | |
| 76710 | T-10H | 19 | 53 | 4 | 10 | |
| 76715 | T-15H | 21 | 57 | 6 | 10 | |
| 76720 | T-20H | 23 | 61 | 7 | 10 | |
| 76725 | T-25H | 25 | 65 | 11 | 10 | |
| 76727 | T-27H | 26 | 68 | 12 | 10 | |
| 76730 | T-30H | 29 | 75 | 20 | 10 | |
| 76740 | T-40H | 33 | 83 | 30 | 10 | |
| 76745 | T-45H | 36 | 90 | 42 | 10 | |
| 76747 ^{NEW} | T-47H | 38 | 95 | 58 | 10 | |
| 76750 | T-50H | 40 | 104 | 62 | 10 | |
| 76755 | T-55H | 45 | 118 | 124 | 10 | |
| 76760 | T-60H | 52 | 131 | 186 | 5 | |

Star tamperproof long key

| 767..L | | | | | | |
|-----------------------|-------|-------|------|-----|--------|--|
| Part no. | Tip | short | long | g | pc/bag | |
| 76706L | T-6H | 18 | 68 | 5 | 10 | |
| 76707L | T-7H | 18 | 73 | 6 | 10 | |
| 76708L | T-8H | 18 | 77 | 6 | 10 | |
| 76709L | T-9H | 18 | 82 | 6 | 10 | |
| 76710L | T-10H | 19 | 86 | 6 | 10 | |
| 76715L | T-15H | 21 | 90 | 8 | 10 | |
| 76720L | T-20H | 23 | 95 | 11 | 10 | |
| 76725L | T-25H | 25 | 98 | 18 | 10 | |
| 76727L | T-27H | 26 | 105 | 19 | 10 | |
| 76730L | T-30H | 29 | 115 | 30 | 10 | |
| 76735L ^{NEW} | T-35H | 30 | 119 | 43 | 10 | |
| 76740L | T-40H | 33 | 122 | 45 | 10 | |
| 76745L | T-45H | 36 | 138 | 62 | 10 | |
| 76750L | T-50H | 40 | 155 | 90 | 10 | |
| 76755L | T-55H | 45 | 172 | 164 | 10 | |
| 76760L | T-60H | 52 | 200 | 267 | 5 | |

NEW



Star & star ball point long key

| 766...BL | | | | | |
|----------|-----|-----------|----------|------|--------|
| Part no. | Tip | Short(mm) | Long(mm) | g | pc/bag |
| 76610BL | 8 | 17 | 72 | 4.9 | 10 |
| 76615BL | 10 | 17 | 82 | 9.8 | 10 |
| 76620BL | 11 | 18 | 91 | 10.7 | 10 |
| 76625BL | 12 | 18 | 95 | 17.5 | 10 |
| 76627BL | 13 | 20 | 103 | 19.0 | 10 |
| 76630BL | 14 | 24 | 113 | 30.5 | 10 |
| 76640BL | 17 | 26 | 132 | 48.0 | 10 |
| 76645BL | 19 | 30 | 134 | 65.0 | 10 |
| 76650BL | 22 | 32 | 136 | 84.0 | 10 |



Spline key

| 768..K | | | | | |
|----------|-----|-------|------|-----|--------|
| Part no. | Tip | short | long | g | pc/bag |
| 76805K | M5 | 26 | 70 | 15 | 10 |
| 76806K | M6 | 31 | 75 | 31 | 10 |
| 76808K | M8 | 36 | 83 | 49 | 10 |
| 76810K | M10 | 41 | 96 | 86 | 10 |
| 76812K | M12 | 47 | 107 | 125 | 10 |
| 76814K | M14 | 52 | 118 | 186 | 5 |
| 76816K | M16 | 61 | 134 | 287 | 5 |

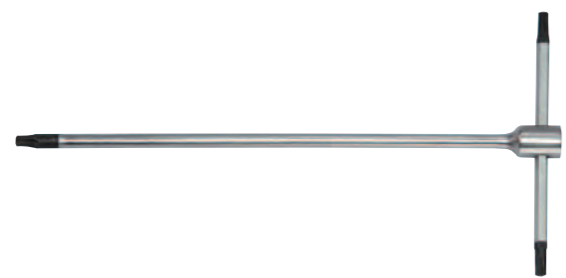

T-shape star key

| 766..T | | | | | |
|----------|-----|-------|-------|-----|--------|
| Part no. | Tip | blade | width | g | pc/box |
| 76606T | T6 | 62 | 125 | 20 | 10 |
| 76607T | T7 | 62 | 125 | 20 | 10 |
| 76608T | T8 | 62 | 125 | 20 | 10 |
| 76609T | T9 | 62 | 125 | 20 | 10 |
| 76610T | T10 | 75 | 150 | 25 | 10 |
| 76615T | T15 | 75 | 150 | 25 | 10 |
| 76620T | T20 | 75 | 150 | 25 | 10 |
| 76625T | T25 | 90 | 180 | 60 | 10 |
| 76627T | T27 | 90 | 180 | 60 | 10 |
| 76630T | T30 | 90 | 180 | 62 | 10 |
| 76640T | T40 | 105 | 210 | 135 | 10 |
| 76645T | T45 | 105 | 210 | 138 | 10 |
| 76650T | T50 | 125 | 250 | 220 | 10 |
| 76655T | T55 | 150 | 300 | 450 | 10 |
| 76660T | T60 | 160 | 320 | 650 | 5 |



Five-sided star tamperproof L key

| 76F | | | | | |
|----------|------|-------|------|----|--------|
| Part no. | Tip | short | long | g | pc/bag |
| 76F10 | TS10 | 19 | 53 | 4 | 10 |
| 76F15 | TS15 | 21 | 57 | 6 | 10 |
| 76F20 | TS20 | 223 | 61 | 8 | 10 |
| 76F25 | TS25 | 25 | 65 | 12 | 10 |
| 76F27 | TS27 | 26 | 68 | 12 | 10 |
| 76F30 | TS30 | 29 | 75 | 20 | 10 |
| 76F40 | TS40 | 33 | 83 | 30 | 10 |
| 76F45 | TS45 | 36 | 90 | 42 | 10 |
| 76F50 | TS50 | 40 | 104 | 62 | 10 |



Hex nut driver T handle

| 774 | | | | | |
|----------------------------|--------|-------|------|-----|--------|
| Part no. | Tip | blade | over | g | pc/box |
| 77430004 | 4 | 260 | 300 | 121 | 10 |
| 774300045 | 4.5 | 260 | 300 | 122 | 10 |
| 77430005 | 5 | 260 | 300 | 122 | 10 |
| 774300055 | 5.5 | 260 | 300 | 127 | 10 |
| 77430006 | 6 | 260 | 300 | 130 | 10 |
| 77430007 | 7 | 260 | 300 | 133 | 10 |
| 77430008 | 8 | 260 | 300 | 137 | 10 |
| 77430009 | 9 | 260 | 300 | 139 | 10 |
| 77430010 | 10 | 260 | 300 | 202 | 10 |
| 77430011 | 11 | 260 | 300 | 202 | 10 |
| 77430012 | 12 | 260 | 300 | 204 | 10 |
| 77430013 | 13 | 260 | 300 | 224 | 10 |
| 77430014 | 14 | 260 | 300 | 270 | 10 |
| 77430017 | 17 | 260 | 300 | 308 | 10 |
| 7743003.16 | 3/16" | 260 | 300 | 122 | 10 |
| 7743001.4 | 1/4" | 260 | 300 | 127 | 10 |
| 7743009.32 ^{NEW} | 9/32" | 260 | 300 | 136 | 10 |
| 7743005.16 | 5/16" | 260 | 300 | 137 | 10 |
| 77430011.32 ^{NEW} | 11/32" | 260 | 300 | 142 | 10 |
| 7743003.8 | 3/8" | 260 | 300 | 202 | 10 |
| 7743007.16 | 7/16" | 260 | 300 | 202 | 10 |
| 7743001.2 | 1/2" | 260 | 300 | 204 | 10 |
| 7743009.16 | 9/16" | 260 | 300 | 270 | 10 |
| 7743005.8 | 5/8" | 260 | 300 | 308 | 10 |

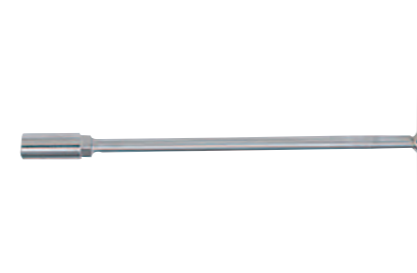

Hex nut driver T handle

| 774..A | | | | | |
|----------|-----|-------|------|-----|--------|
| Part no. | Tip | blade | over | g | pc/box |
| 77406A | 6 | 300 | 200 | 220 | 10 |
| 77407A | 7 | 300 | 200 | 220 | 10 |
| 77408A | 8 | 300 | 200 | 279 | 10 |
| 77409A | 9 | 300 | 200 | 285 | 10 |
| 77410A | 10 | 300 | 200 | 294 | 10 |
| 77411A | 11 | 300 | 200 | 318 | 10 |
| 77412A | 12 | 300 | 200 | 432 | 10 |
| 77413A | 13 | 300 | 200 | 346 | 10 |

Hex nut driver T handle

| 774..A | | | | | |
|-----------------------|-------|-------|------|-----|--------|
| Part no. | Tip | blade | over | g | pc/box |
| 77414A | 14 | 300 | 200 | 422 | 10 |
| 77415A | 15 | 300 | 200 | 480 | 10 |
| 77416A | 16 | 300 | 200 | 510 | 10 |
| 77417A | 17 | 300 | 200 | 542 | 10 |
| 77418A | 18 | 300 | 200 | 600 | 10 |
| 77419A | 19 | 300 | 200 | 620 | 5 |
| 77420A | 20 | 300 | 200 | 650 | 5 |
| 77421A | 21 | 300 | 200 | 715 | 5 |
| 77422A | 22 | 300 | 200 | 715 | 5 |
| 77424A ^{NEW} | 24 | 300 | 200 | 702 | 5 |
| 7741.4A | 1/4" | 300 | 200 | 220 | 10 |
| 7745.16A | 5/16" | 300 | 200 | 279 | 10 |
| 7743.8A | 3/8" | 300 | 200 | 294 | 10 |
| 7747.16A | 7/16" | 300 | 200 | 318 | 10 |
| 7741.2A | 1/2" | 300 | 200 | 342 | 10 |
| 7749.16A | 9/16" | 300 | 200 | 422 | 10 |
| 7745.8A | 5/8" | 300 | 200 | 510 | 10 |
| 7743.4A | 3/4" | 300 | 200 | 620 | 5 |

NEW

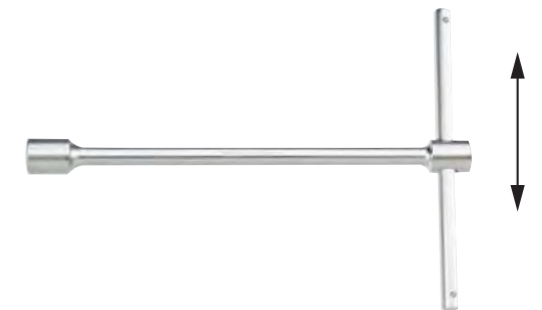

Hex nut driver adjustable T handle

| 774...B | | | | | |
|----------|-----|-------|------|-----|--------|
| Part no. | Tip | blade | over | g | pc/box |
| 77407B | 7 | 220 | 200 | 190 | 10 |
| 77408B | 8 | 240 | 200 | 195 | 10 |
| 77410B | 10 | 260 | 200 | 265 | 10 |
| 77412B | 12 | 260 | 200 | 380 | 10 |
| 77413B | 13 | 260 | 200 | 380 | 10 |
| 77414B | 14 | 260 | 200 | 385 | 10 |
| 77417B | 17 | 290 | 250 | 500 | 10 |
| 77422B | 22 | 315 | 250 | 715 | 10 |



Star nut driver T handle

| 776 | | <i>l</i> | <i>l</i> | | |
|----------|-----|----------|----------|-----|--------|
| Part no. | Tip | blade | over | g | pc/box |
| 77604 | E4 | 260 | 300 | 121 | 10 |
| 77605 | E5 | 260 | 300 | 121 | 10 |
| 77606 | E6 | 260 | 300 | 123 | 10 |
| 77607 | E7 | 260 | 300 | 141 | 10 |
| 77608 | E8 | 260 | 300 | 145 | 10 |
| 77610 | E10 | 260 | 300 | 148 | 10 |
| 77611 | E11 | 260 | 300 | 156 | 10 |
| 77612 | E12 | 260 | 300 | 218 | 10 |
| 77614 | E14 | 260 | 300 | 237 | 10 |
| 77616 | E16 | 260 | 300 | 262 | 10 |

3/8"DR. Universal long nut driver (joint type)

| 784..U | | <i>l</i> | <i>l</i> | |
|------------|-----|----------|----------|-----|
| Part no. | Tip | blade | width | g |
| 784332008U | 8 | 320 | 200 | 350 |
| 784332010U | 10 | 320 | 200 | 350 |
| 784332011U | 11 | 320 | 200 | 352 |
| 784332012U | 12 | 320 | 200 | 352 |
| 784332013U | 13 | 320 | 200 | 352 |
| 784332014U | 14 | 320 | 200 | 372 |
| 784345008U | 8 | 450 | 200 | 418 |
| 784345010U | 10 | 450 | 200 | 418 |
| 784345011U | 11 | 450 | 200 | 420 |
| 784345012U | 12 | 450 | 200 | 420 |
| 784345013U | 13 | 450 | 200 | 420 |
| 784345014U | 14 | 450 | 200 | 440 |
| 784360008U | 8 | 600 | 200 | 498 |
| 784360010U | 10 | 600 | 200 | 498 |
| 784360011U | 11 | 600 | 200 | 500 |
| 784360012U | 12 | 600 | 200 | 500 |
| 784360013U | 13 | 600 | 200 | 500 |
| 784360014U | 14 | 600 | 200 | 520 |

3/8"DR. Universal long nut driver (ball type)

| 784..B | | <i>l</i> | <i>l</i> | |
|------------|-----|----------|----------|-----|
| Part no. | Tip | blade | width | g |
| 784332008B | 8 | 320 | 200 | 338 |
| 784332010B | 10 | 320 | 200 | 338 |
| 784332011B | 11 | 320 | 200 | 340 |
| 784332012B | 12 | 320 | 200 | 340 |
| 784332013B | 13 | 320 | 200 | 340 |
| 784332014B | 14 | 320 | 200 | 360 |
| 784345008B | 8 | 450 | 200 | 406 |
| 784345010B | 10 | 450 | 200 | 406 |
| 784345011B | 11 | 450 | 200 | 408 |
| 784345012B | 12 | 450 | 200 | 408 |
| 784345013B | 13 | 450 | 200 | 408 |
| 784345014B | 14 | 450 | 200 | 428 |
| 784360008B | 8 | 600 | 200 | 486 |
| 784360010B | 10 | 600 | 200 | 486 |
| 784360011B | 11 | 600 | 200 | 488 |
| 784360012B | 12 | 600 | 200 | 488 |
| 784360013B | 13 | 600 | 200 | 488 |
| 784360014B | 14 | 600 | 200 | 508 |

Universal long nut driver (joint type)

| 784..U | | <i>l</i> | <i>l</i> | |
|----------|-----|----------|----------|-----|
| Part no. | Tip | blade | width | g |
| 784206U | 6 | 400 | 165 | 210 |
| 784207U | 7 | 400 | 165 | 210 |
| 784208U | 8 | 400 | 165 | 210 |
| 784209U | 9 | 450 | 175 | 240 |

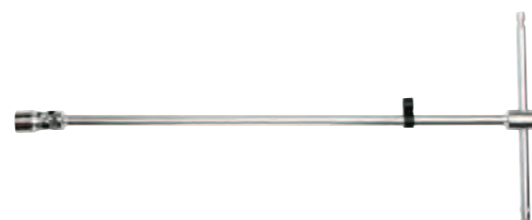

| 784..U | | <i>l</i> | <i>l</i> | |
|----------------|-----|----------|----------|-----|
| Part no. | Tip | blade | width | g |
| 3/8"DR. | | | | |
| 784310U | 10 | 450 | 175 | 392 |
| 784311U | 11 | 450 | 175 | 394 |
| 784312U | 12 | 450 | 175 | 395 |
| 784313U | 13 | 450 | 175 | 425 |
| 784314U | 14 | 500 | 180 | 425 |
| 784315U | 15 | 500 | 180 | 430 |
| 784316U | 16 | 500 | 180 | 430 |
| 784317U | 17 | 500 | 180 | 430 |
| 1/2"DR. | | | | |
| 784418U | 18 | 500 | 180 | 820 |
| 784419U | 19 | 500 | 220 | 880 |
| 784420U | 20 | 500 | 220 | 880 |
| 784421U | 21 | 500 | 220 | 900 |
| 784422U | 22 | 500 | 220 | 900 |
| 784424U | 24 | 500 | 220 | 920 |

| 791 | <i>l</i> | | | |
|------------|----------|-----|------|--------|
| Part no. | size | mm | g | pc/box |
| 79136 | 36 | 299 | 700 | 10 |
| 79138 | 38 | 299 | 700 | 10 |
| 79141 | 41 | 339 | 1015 | 5 |
| 79142 | 42 | 339 | 1015 | 5 |
| 79143 | 43 | 339 | 1015 | 5 |
| 79144 | 44 | 374 | 1230 | 2 |
| 79145 | 45 | 374 | 1230 | 2 |
| 79146 | 46 | 374 | 1230 | 2 |
| 79148 | 48 | 417 | 1810 | 2 |
| 79150 | 50 | 417 | 1810 | 2 |
| 79152 | 52 | 417 | 1810 | 2 |
| 79155 | 55 | 496 | 2720 | 5 |
| 79156 | 56 | 496 | 2720 | 5 |
| 79158 | 58 | 496 | 2720 | 5 |
| 79160 | 60 | 496 | 2720 | 5 |
| 79165 | 65 | 520 | 1850 | 10 |
| 79170 | 70 | 560 | 2300 | 5 |
| 79175 | 75 | 600 | 2800 | 5 |
| 79180 | 80 | 630 | 3250 | 5 |
| 79185 | 85 | 660 | 3650 | 5 |
| 79190 | 90 | 680 | 4800 | 4 |
| 79195 | 95 | 820 | 5800 | 4 |
| 791100 | 100 | 840 | 6000 | 4 |
| 7915.8 | 5/8" | 197 | 177 | 10 |
| 79111.16 | 11/16" | 197 | 177 | 10 |
| 7913.4 | 3/4" | 217 | 266 | 10 |
| 79113.16 | 13/16" | 217 | 266 | 10 |
| 7917.8 | 7/8" | 243 | 352 | 10 |
| 79115.16 | 15/16" | 273 | 467 | 10 |
| 7911.0 | 1" | 273 | 467 | 10 |
| 7911.1.16 | 1-1/16" | 299 | 700 | 10 |
| 7911.1.8 | 1-1/8" | 299 | 700 | 10 |
| 7911.1.4 | 1-1/4" | 299 | 700 | 10 |
| 7911.5.16 | 1-5/16" | 339 | 1015 | 5 |
| 7911.3.8 | 1-3/8" | 339 | 1015 | 5 |
| 7911.7.16 | 1-7/16" | 374 | 1230 | 2 |
| 7911.1.2 | 1-1/2" | 374 | 1230 | 2 |
| 7911.5.8 | 1-5/8" | 417 | 1810 | 2 |
| 7911.11.16 | 1-11/16" | 417 | 1810 | 2 |
| 7911.3.4 | 1-3/4" | 417 | 100 | 2 |
| 7911.13.16 | 1-13/16" | 417 | 100 | 2 |
| 7911.7.8 | 1-7/8" | 417 | 120 | 2 |
| 7912.0 | 2" | 417 | 120 | 2 |

Single open end wrench

| 791 | <i>l</i> | | | |
|----------|----------|-----|-----|--------|
| Part no. | size | mm | g | pc/box |
| 79116 | 16 | 162 | 100 | 10 |
| 79117 | 17 | 162 | 100 | 10 |
| 79118 | 18 | 162 | 100 | 10 |
| 79119 | 19 | 177 | 120 | 10 |
| 79120 | 20 | 177 | 120 | 10 |
| 79121 | 21 | 177 | 120 | 10 |
| 79122 | 22 | 197 | 177 | 10 |
| 79123 | 23 | 197 | 177 | 10 |
| 79124 | 24 | 197 | 177 | 10 |
| 79125 | 25 | 217 | 266 | 10 |
| 79126 | 26 | 217 | 266 | 10 |
| 79127 | 27 | 217 | 266 | 10 |
| 79128 | 28 | 243 | 352 | 10 |
| 79129 | 29 | 243 | 352 | 10 |
| 79130 | 30 | 268 | 352 | 10 |
| 79132 | 32 | 273 | 467 | 10 |
| 79133 | 33 | 273 | 467 | 10 |
| 79134 | 34 | 273 | 467 | 10 |
| 79135 | 35 | 299 | 700 | 10 |





Single ring wrench

| 792 | | | | |
|--------------------------|------|---------|------|--------|
| Part no. | size | l mm | g | pc/box |
| 79217 | 17 | 324 | 340 | 5 |
| 79218 <small>NEW</small> | 18 | 324 | 340 | 5 |
| 79219 | 19 | 324 | 340 | 5 |
| 79221 | 21 | 368 | 542 | 5 |
| 79222 | 22 | 368 | 542 | 5 |
| 79223 | 23 | 368 | 542 | 5 |
| 79224 | 24 | 380 | 678 | 5 |
| 79226 | 26 | 380 | 678 | 5 |
| 79227 | 27 | 393 | 762 | 5 |
| 79229 | 29 | 393 | 762 | 5 |
| 79230 | 30 | 409 | 870 | 5 |
| 79232 | 32 | 409 | 870 | 5 |
| 79234 | 34 | 465 | 1422 | 2 |
| 79235 | 35 | 465 | 1422 | 2 |
| 79236 | 36 | 465 | 1422 | 2 |
| 79238 | 38 | 490 | 1676 | 2 |
| 79241 | 41 | 490 | 1676 | 2 |
| 79242 <small>NEW</small> | 42 | 505 | 1853 | 2 |
| 79243 | 43 | 519 | 2030 | 2 |
| 79244 | 44 | 519 | 2030 | 2 |
| 79246 | 46 | 519 | 2030 | 2 |
| 79248 | 48 | 594 | 3100 | 4 |
| 79250 | 50 | 594 | 3200 | 4 |
| 79252 <small>NEW</small> | 52 | 594 | 3200 | 4 |
| 79255 | 55 | 594 | 3200 | 5 |
| 79256 <small>NEW</small> | 56 | 594 | 3200 | 5 |
| 79258 | 58 | 616 | 4860 | 5 |
| 79260 | 60 | 616 | 4860 | 5 |
| 79265 | 65 | 616 | 4860 | 5 |



Slugging wrench

| 793 | | | | |
|--------------------------|------|---------|-------|--------|
| Part no. | size | l mm | g | pc/box |
| 79322 | 22 | 163 | 242 | 10 |
| 79323 | 23 | 163 | 242 | 10 |
| 79324 | 24 | 163 | 242 | 10 |
| 79325 | 25 | 163 | 242 | 10 |
| 79326 | 26 | 180 | 340 | 10 |
| 79327 | 27 | 180 | 340 | 10 |
| 79328 | 28 | 180 | 340 | 10 |
| 79329 | 29 | 190 | 416 | 10 |
| 79330 | 30 | 190 | 416 | 10 |
| 79332 | 32 | 190 | 416 | 10 |
| 79333 | 33 | 190 | 416 | 10 |
| 79334 | 34 | 205 | 518 | 5 |
| 79335 | 35 | 205 | 518 | 5 |
| 79336 | 36 | 205 | 518 | 5 |
| 79338 | 38 | 205 | 518 | 5 |
| 79340 | 40 | 230 | 735 | 5 |
| 79341 | 41 | 230 | 735 | 5 |
| 79342 | 42 | 230 | 735 | 5 |
| 79343 | 43 | 230 | 735 | 5 |
| 79344 | 44 | 240 | 930 | 5 |
| 79345 | 45 | 240 | 930 | 5 |
| 79346 | 46 | 240 | 930 | 5 |
| 79347 | 47 | 240 | 930 | 5 |
| 79348 | 48 | 255 | 1162 | 5 |
| 79350 | 50 | 255 | 1162 | 5 |
| 79352 | 52 | 255 | 1162 | 5 |
| 79355 | 55 | 270 | 1362 | 5 |
| 79356 <small>NEW</small> | 56 | 273 | 1423 | 5 |
| 79360 | 60 | 280 | 1681 | 5 |
| 79365 | 65 | 300 | 2050 | 5 |
| 79370 | 70 | 320 | 3000 | 6 |
| 79375 | 75 | 320 | 3000 | 6 |
| 79378 <small>NEW</small> | 78 | 350 | 5280 | 4 |
| 79380 | 80 | 350 | 4000 | 4 |
| 79382 <small>NEW</small> | 82 | 350 | 5037 | 4 |
| 79385 | 85 | 350 | 4000 | 4 |
| 79390 | 90 | 390 | 5450 | 3 |
| 79395 | 95 | 390 | 5450 | 3 |
| 79398 <small>NEW</small> | 98 | 390 | 6624 | 2 |
| 793100 | 100 | 420 | 9777 | 2 |
| 793105 | 105 | 420 | 9360 | 2 |
| 793110 | 110 | 450 | 8470 | 2 |
| 793115 | 115 | 450 | 8855 | 2 |
| 793120 | 120 | 480 | 11900 | 1 |
| 793125 | 125 | 480 | 11500 | 1 |
| 793130 | 130 | 510 | 14080 | 1 |

| 793 | | | | |
|------------|----------|---------|------|--------|
| Part no. | size | l mm | g | pc/box |
| 7931.0 | 1" | 163 | 242 | 10 |
| 7931.1.16 | 1-1/16" | 180 | 340 | 10 |
| 7931.1.8 | 1-1/8" | 190 | 416 | 10 |
| 7931.3.16 | 1-3/16" | 190 | 416 | 10 |
| 7931.1.4 | 1-1/4" | 190 | 416 | 10 |
| 7931.5.16 | 1-5/16" | 190 | 416 | 10 |
| 7931.3.8 | 1-3/8" | 205 | 518 | 5 |
| 7931.7.16 | 1-7/16" | 205 | 518 | 5 |
| 7931.1.2 | 1-1/2" | 205 | 518 | 5 |
| 7931.5.8 | 1-5/8" | 230 | 735 | 5 |
| 7931.11.16 | 1-11/16" | 230 | 735 | 5 |
| 7931.3.4 | 1-3/4" | 240 | 930 | 5 |
| 7931.13.16 | 1-13/16" | 240 | 930 | 5 |
| 7931.7.8 | 1-7/8" | 255 | 1162 | 5 |
| 7932.0 | 2" | 255 | 1162 | 5 |



Slugging wrench, deep offset

| 794 | | | | |
|------------|------------|---------|------|--------|
| Part no. | Size mm | l mm | g | pc/box |
| 79424 | 24 | 250 | 1300 | 2 |
| 79427 | 27 | 250 | 1260 | 2 |
| 79430 | 30 | 270 | 1505 | 2 |
| 79432 | 32 | 270 | 1465 | 2 |
| 79436 | 36 | 300 | 1800 | 2 |
| 79438 | 38 | 300 | 1760 | 2 |
| 79441 | 41 | 320 | 2640 | 1 |
| 79443 | 43 | 320 | 2580 | 1 |

| 794 | | | | |
|------------|------------|---------|-------|--------|
| Part no. | Size mm | l mm | g | pc/box |
| 79446 | 46 | 360 | 3400 | 6 |
| 79450 | 50 | 360 | 3300 | 6 |
| 79455 | 55 | 360 | 3440 | 5 |
| 79460 | 60 | 360 | 3560 | 4 |
| 79465 | 65 | 380 | 5500 | 2 |
| 79470 | 70 | 380 | 7900 | 2 |
| 79475 | 75 | 420 | 7000 | 2 |
| 79480 | 80 | 420 | 7460 | 2 |
| 79485 | 85 | 450 | 8000 | 1 |
| 79490 | 90 | 450 | 10750 | 1 |
| 79495 | 95 | 500 | 13920 | 1 |
| 79498 | 98 | 500 | 13660 | 1 |
| 794100 | 100 | 500 | 13560 | 1 |
| 794105 | 105 | 515 | 14260 | 1 |
| 794110 | 110 | 515 | 13480 | 1 |
| 794115 | 115 | 515 | 13420 | 1 |



Single ended ring spanner deep offset

| 795 | | | | |
|------------|------------|---------|------|--------|
| Part no. | Size mm | l mm | g | pc/box |
| 79524 | 24 | 195 | 640 | 5 |
| 79527 | 27 | 195 | 600 | 5 |
| 79530 | 30 | 200 | 745 | 5 |
| 79532 | 32 | 200 | 705 | 5 |
| 79536 | 36 | 216 | 1040 | 5 |
| 79538 | 38 | 216 | 1020 | 2 |
| 79541 | 41 | 247 | 1360 | 2 |
| 79543 | 43 | 247 | 1320 | 2 |
| 79546 | 46 | 274 | 1860 | 2 |
| 79550 | 50 | 274 | 1800 | 2 |
| 79555 | 55 | 287 | 2120 | 2 |

| 795 | | | | |
|------------|------------|---------|-------|--------|
| Part no. | Size mm | l mm | g | pc/box |
| 79560 | 60 | 300 | 2340 | 8 |
| 79565 | 65 | 309 | 3500 | 6 |
| 79570 | 70 | 309 | 3340 | 6 |
| 79575 | 75 | 340 | 4500 | 4 |
| 79580 | 80 | 340 | 4760 | 4 |
| 79585 | 85 | 365 | 7220 | 2 |
| 79590 | 90 | 365 | 7040 | 2 |
| 79595 | 95 | 378 | 9080 | 2 |
| 795100 | 100 | 378 | 8720 | 2 |
| 795105 | 105 | 380 | 9340 | 2 |
| 795110 | 110 | 380 | 10040 | 2 |
| 795115 | 115 | 380 | 9480 | 2 |



Extension bar for Single ended ring spanner

| 795 | | | |
|------------|---------|------|--------|
| Part no. | l mm | g | pc/box |
| 795350 | 350 | 960 | 20 |
| 795580 | 580 | 1600 | 10 |
| 795850 | 850 | 2300 | 10 |

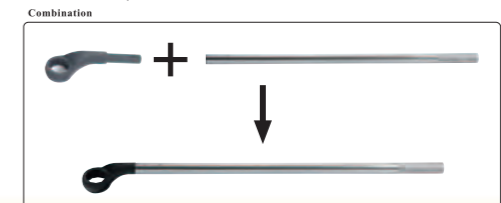



NEW



4pc 1/4" Ratchet handle set

| | | |
|------------------|------------------------------------|-------|
| 2045 | | |
| Part no. | 6/10.7/11.7/0.9' | 1220g |
| Content: 1/4"DR. | | |
| 6472270 | 1-Torque wrench(tone control) | |
| 802215 | 1-20 teeth Ratchet handle | |
| 802219 | 1-20 teeth Stubby ratchet handle | |
| 802218 | 1-20 teeth Flexible ratchet handle | |



4pc 1/4" Ratchet handle set

| | | |
|------------------|--|-------|
| 2046 | | |
| Part no. | 6/7.5/8.5/0.66' | 1230g |
| Content: 1/4"DR. | | |
| 6472300W | 1-Lock torque wrench - window display (tone control) | |
| 80222 | 1-24 teeth ratchet handle | |
| 802219 | 1-20 teeth stubby ratchet handle | |
| 802223 | 1-72 teeth flexible ratchet handle | |



6pc 1/4" Star deep socket set

| | | | |
|------------------|--|-------------------|------|
| 2062 | | | |
| Part no. | Socket | 60/10.2/11.2/1.5' | 180g |
| Content: 1/4"DR. | | | |
| 52650 04...10 | 6- Star deep socket E4; E5; E6; E7; E8; E10 (50mmL) | | |



7pc 1/4" Star tamperproof bit set

| | | | |
|---------------|---|--------------------|-----|
| 2071 | | | |
| Part no. | Bit | 200/12.0/13.0/1.3' | 60g |
| Content: 1/4" | | | |
| 12725 10...40 | 7- Star tamperproof bit (25mmL) T-10H; T-15H; T-20H; T-25H; T-27H; T-30H; T-40H | | |

NEW



7pc Five-sided star tamperproof socket bit set

| | | | |
|-------------------|--|--------------------|------|
| 20711 | | | |
| Part no. | Bit | 100/14.5/15.5/1.8' | 145g |
| Content: 1/4" DR. | | | |
| 32F32 10...40 | 7-Five-sided star tamper socket bit TS10; TS15; TS20; TS25; TS27; TS30; TS40 | | |



7pc 1/4" Hex socket bit set (MM)

| | | | |
|------------------|--|--------------------|------|
| 2073 | | | |
| Part no. | Bit | 100/15.0/16.0/1.8' | 150g |
| Content: 1/4"DR. | | | |
| 32432 03...10 | 7- Hex socket bit (32mmL) 3; 4; 5; 6; 7; 8; 10 mm | | |

7pc 1/4" Hex socket bit set (SAE)

| | | | |
|------------------|--|--------------------|------|
| 2073S | | | |
| Part no. | Bit | 100/15.0/16.0/1.8' | 150g |
| Content: 1/4"DR. | | | |
| 32432 1.8...3.8 | 7- Hex socket bit (32mmL) 1/8"; 5/32"; 3/16"; 7/32"; 1/4"; 5/16"; 3/8" | | |



8pc 1/4" Bit set

| | | |
|-----------------|---|------|
| 2081A | | |
| Part no. | 100/14.0/15.0/1.5' | 140g |
| Content: 1/4" | | |
| 12130 1G...3G | 3-Phillips bit PH.1; PH.2; PH.3 (30mmL) | |
| 12230 1G...2G | 2-Pozidriv bit PZ.1; PZ.2 (30mmL) | |
| 12330 04G...07G | 2-Slotted bit 4; 7 mm (30mmL) | |
| 8152105 | 1-Offset bit holder wrench | |



8pc 1/4" Star tamperproof bit set

| | | | |
|-----------------|--|--------------------|------|
| 2081 | | | |
| Part no. | Bit | 100/14.0/15.0/1.5' | 140g |
| Content: 1/4" | | | |
| 12730 10G...40G | 7-Star tamperproof bit (30mmL) T-10H; T-15H; T-20H; T-25H; T-27H; T-30H; T-40H | | |
| 8152105 | 1-Offset bit holder wrench | | |



8pc 1/4" Hex bit set

| | | | |
|-----------------|--|--------------------|------|
| 2081B | | | |
| Part no. | Bit | 100/14.0/15.0/1.5' | 140g |
| Content: 1/4" | | | |
| 12430 02G...08G | 7-Hex bit 2; 3; 4; 5; 6; 7; 8 mm (30mmL) | | |
| 8152105 | 1-Offset bit holder wrench | | |



8pc 1/4" Bit set

| | | |
|---------------|--|------|
| 2081C | | |
| Part no. | 100/14.0/15.0/1.5' | 140g |
| 12130 1G...3G | Content: 1/4" 3-Phillips bit PH.1; PH.2; PH.3 (30mmL) | |
| 12230 1G...3G | 3-Pozidriv bit PZ.1; PZ.2; PZ.3 (30mmL) | |
| 1233007G | 1-Slotted bit 7 mm (30mmL) | |
| 8152105 | 1-Offset bit holder wrench | |



8pc 1/4" Star bit set

| | | |
|----------------|---|------|
| 2081D | | |
| Part no. | Bit 100/14.0/15.0/1.5' | 140g |
| 12630 10...40G | Content: 1/4" 7-Star bit T10; T15; T20; T25; T27; T30; T40 (30mmL) | |
| 8152105 | 1-Offset bit holder wrench | |

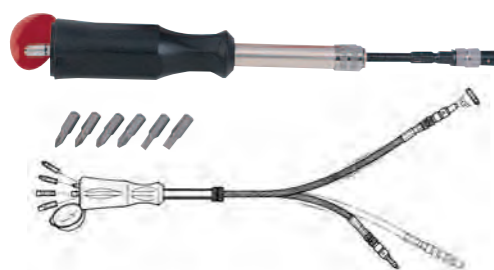

8pc 1/4" bit set

| | | |
|----------------|--|------|
| 2083 | | |
| Part no. | 60/14.4/15.4/3' | 240g |
| 8146 | Content: 1/4" 1-Flexible telescope bit driver | |
| 12125 1...2 | 2-Phillips bit PH.1; PH.2 (25mmL) | |
| 12225 1...2 | 2-Pozidriv bit PZ.1; PZ.2 (25mmL) | |
| 12325 04...055 | 2-Slotted bit 4; 5.5 mm (25mmL) | |
| 8092225M | 1-Magnet bit adaptor | |



10pc Phillips bit set

| | | |
|-------------|---|------|
| 2101 | | |
| Part no. | Bit 100/11.6/12.6/0.8' | 116g |
| 121452D | Content: 1/4" 10- Double end phillips bit PH.2 (45mmL) | |

10pc Phillips long bit set

| | | |
|--------------|--|------|
| 2101L | | |
| Part no. | Bit 100/11.6/12.6/0.8' | 116g |
| 121652D | Content: 1/4" 10- Double end phillips long bit PH.2 (65mmL) | |



10pc 1/4" Bit set

| | | |
|----------------|---|------|
| 21010 | | |
| Part no. | 100/10.0/11.0/1.5' | 100g |
| 12125 0...3 | Content: 4-1/4" Phillips bit (25mmL) PH.0; PH.1; PH.2; PH.3 | |
| 12225 1...3 | 3-1/4" Pozidriv bit (25mmL) PZ.1; PZ.2; PZ.3 | |
| 12325 04...065 | 3-1/4" Slotted bit (25mmL) 4; 5.5; 6.5 mm | |



10pc 1/4" Hex bit set

| | | |
|---------------|---|------|
| 21011 | | |
| Part no. | Bit 100/12.1/13.1/1.5' | 121g |
| 12425 02...10 | Content: 10-1/4" Hex bit (25mmL) 2; 2.5; 3; 4; 5; 5.5; 6; 7; 8; 10 mm | |



10pc 1/4" Star bit set

| | | |
|---------------|---|------|
| 21012 | | |
| Part no. | Bit 100/10.0/11.0/1.5' | 100g |
| 12625 07...40 | Content: 10-1/4" Star bit (25mmL) T7; T8; T9; T10; T15; T20; T25; T27; T30; T40 | |

10pc 1/4" Star tamperproof bit set

| | | |
|---------------|---|------|
| 21012T | | |
| Part no. | Bit 100/10.0/11.0/1.5' | 100g |
| 12725 07...40 | Content: 10-1/4" Star tamperproof bit (25mmL) T-7H; T-8H; T-9H; T-10H; T-15H; T-20H; T-25H; T-27H; T-30H; T-40H | |



10pc 1/4" 5-Sided star tamperproof bit set

| | | |
|---------------|---|------|
| 21013 | | |
| Part no. | Bit 100/10.0/11.0/1.5' | 100g |
| 12F25 08...50 | Content: 10-1/4" 5-Sided star tamperproof bit (25mmL) TS08; TS10; TS15; TS20; TS25; TS27; TS30; TS40; TS45; TS50 | |



NEW



10pc 1/4" DR. 12pt. Flank deep socket set

| | | |
|---------------|--|------|
| 21014 | | |
| Part no. | Socket 48/17.3/18.3/1.4' | 360g |
| 52950 05...14 | Content: 1/4" DR. 10-12pt. Flank deep socket 5; 6; 7; 8; 9; 10; 11; 12; 13; 14mm | |

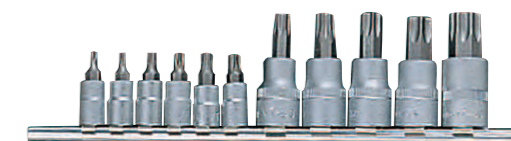

11pc Star socket bit set

| | | |
|---------------|--|------|
| 2111I | | |
| Part no. | Bit 48/20.5/21.5/1.4' | 428g |
| 32632 10...30 | Content: 1/4" & 3/8" DR. 6-1/4" DR. Star socket bit (32mmL) T10; T15; T20; T25; T27; T30 | |
| 33650 40...60 | 5-3/8"DR. Star socket bit (50mmL) T40; T45; T50; T55; T60 | |

11pc Star tamperproof socket bit set

| | | |
|---------------|---|------|
| 2112I | | |
| Part no. | Bit 48/20.5/21.5/1.4' | 428g |
| 32732 10...30 | Content: 1/4" & 3/8" DR. 6-1/4" DR. Star tamperproof socket bit (32mmL) T-10H; T-15H; T-20H; T-25H; T-27H; T-30H | |
| 33750 40...60 | 5-3/8" DR. Star tamperproof socket bit (50mmL) T-40H; T-45H; T-50H; T-55H; T-60H | |



11pc 1/4" 12pt. Flank socket set (SAE)

| | | | |
|-----------------|---|-------------------|------|
| 21110 | | | |
| Part no. | Socket | 48/11.4/12.4/1.4' | 238g |
| 529 5.32...9.16 | Content: 1/4" DR. 11- 1/4" 12pt. Flank socket 5/32"; 3/16"; 7/32"; 1/4"; 9/32"; 5/16"; 11/32"; 3/8"; 7/16"; 1/2"; 9/16" | | |



11pc 1/4" Bit set

| | | |
|-----------------|---|------|
| 21112 | | |
| Part no. | 100/15.5/16.5/0.96' | 155g |
| 12125 1...3 | Content: 1/4" DR. 4-Phillips bit PH.1; PH.2; PH.2; PH.3 (25mmL) | |
| 12225 1...3 | 4-Pozidriv bit PZ.1; PZ.2; PZ.2; PZ.3 (25mmL) | |
| 12325 055...065 | 2-Slotted bit 5.5; 6.5 mm (25mmL) | |
| 81260Q | 1-Magnetic quick-release bit holder | |



11pc 1/4" 12pt. Deep socket set (SAE)

| | | | |
|-------------------|---|-------------------|------|
| 21110D | | | |
| Part no. | Socket | 48/18.4/19.4/1.4' | 383g |
| 52950 5.32...9.16 | Content: 1/4" DR. 11-12pt. deep socket 5/32"; 3/16"; 7/32"; 1/4"; 9/32"; 5/16"; 11/32"; 3/8"; 7/16"; 1/2"; 9/16 " | | |

11pc 1/4" 6pt. Deep socket set (SAE)

| | | | |
|-------------------|--|-------------------|------|
| 21110D-5 | | | |
| Part no. | Socket | 48/18.4/19.4/1.4' | 383g |
| 52550 5.32...9.16 | Content: 1/4" DR. 11-6pt. deep socket 5/32"; 3/16"; 7/32"; 1/4"; 9/32"; 5/16"; 11/32"; 3/8"; 7/16"; 1/2"; 9/16 " | | |



11pc 1/4" Bit set

| | | |
|-----------------|---|------|
| 21111 | | |
| Part no. | 100/15.5/16.5/0.96' | 155g |
| 12125 0...3 | Content: 1/4" DR. 4-Phillips bit PH.0; PH.1; PH.2; PH.3 (25mmL) | |
| 12225 0...3 | 4-Pozidriv bit PZ.0; PZ.1; PZ.2; PZ.3 (25mmL) | |
| 12325 055...065 | 2-Slotted bit 5.5; 6.5 mm (25mmL) | |
| 81260Q | 1-Magnetic quick-release bit holder | |

11pc 1/4" Star bit set

| | | | |
|---------------|---|---------------------|------|
| 21113 | | | |
| Part no. | Bit | 100/15.5/16.5/0.96' | 155g |
| 12625 07...40 | Content: 1/4" DR. 10-1/4" Star bit (25mmL) T7; T8; T9; T10; T15; T20; T25; T27; T30; T40 | | |
| 81260Q | 1-Magnetic quick-release bit holder | | |

11pc 1/4" Star tamperproof bit set

| | | | |
|---------------|---|---------------------|------|
| 21113T | | | |
| Part no. | Bit | 100/15.5/16.5/0.96' | 155g |
| 12725 07...40 | Content: 1/4" DR. 10-1/4" Star tamperproof bit (25mmL) T-7H; T-8H; T-9H; T-10H; T-15H; T-20H; T-25H; T-27H; T-30H; T-40H | | |
| 81260Q | 1-Magnetic quick-release bit holder | | |

NEW



11pc 1/4" DR. 6pt. Flank deep socket set

| | | | |
|---------------|---|-------------------|------|
| 21115 | | | |
| Part no. | Socket | 48/17.8/18.8/1.4' | 370g |
| 52550 04...14 | Content: 1/4" DR. 11-6pt. Flank deep socket 4, 5, 6, 7, 8, 9, 10, 11, 12, 13, 14 mm | | |



13pc 1/4" 12pt. Flank socket set

| | | | |
|-------------|---|-------------------|------|
| 2133 | | | |
| Part no. | Socket | 48/12.0/13.0/1.4' | 270g |
| 529 04...14 | Content: 1/4" DR. 13-1/4" 12pt. Flank socket 4; 4.5; 5; 5.5; 6; 7; 8; 9; 10; 11; 12; 13; 14 mm | | |

13pc 1/4" 6pt. Flank socket set

| | | | |
|--------------------------|---|-------------------|------|
| 2133-5 NEW | | | |
| Part no. | Socket | 48/12.0/13.0/1.4' | 270g |
| 525 4...14 | Content: 1/4" DR. 1-6pt.socket 4; 4.5; 5; 5.5; 6; 7; 8; 9; 10; 11; 12; 13; 14 mm | | |



13pc Spline deep socket set

| | | | |
|---------------|---|-------------------|------|
| 2138Q | | | |
| Part no. | Socket | 48/21.0/22.0/1.2' | 438g |
| 52Q50 04...14 | Content: 1/4" DR. 13-1/4" Spline deep socket (50mmL) 4; 4.5; 5; 5.5; 6; 7; 8; 9; 10; 11; 12; 13; 14 mm | | |



14pc Spline socket set

| | | | |
|--------------|--|-----------------|------|
| 2144Q | | | |
| Part no. | Socket | 48/11.0/12.0/1' | 230g |
| 52Q 032...14 | Content: 1/4" DR. 14- 1/4" Spline socket 3.2; 4; 4.5; 5; 5.5; 6; 7; 8; 9; 10; 11; 12; 13; 14 mm | | |



19pc 1/4" Socket set

| | | | |
|----------------|--|-----------------|------|
| 2203 | | | |
| Part no. | Socket | 15/14.0/15.0/1' | 934g |
| 527 04...14 | Content: 1/4" DR. 13-Surface drive socket 4; 4.5; 5; 5.5; 6; 7; 8; 9; 10; 11; 12; 13; 14 mm | | |
| 80222 | 1-Ratchet handle | | |
| 8042 050...150 | 2-Extension bar 2"; 6" | | |
| 80521 | 1-Universal joint | | |
| 8032115 | 1-Sliding T handle | | |
| 8145 | 1-Spinner | | |

2203-5

| | | | |
|------------------------------|---|-----------------|------|
| 2203-5 | | | |
| Part no. | Socket | 15/14.0/15.0/1' | 934g |
| Changed Items 525 04...14 | Content: 1/4" DR. 13-6pt. Flank socket 4; 4.5; 5; 5.5; 6; 7; 8; 9; 10; 11; 12; 13; 14 mm | | |



19pc 1/4" Socket set

| 2203-72 | | | |
|----------------|--|-----------------|------|
| Part no. | Socket | 15/14.0/15.0/1' | 934g |
| 527 04...14 | Content: 1/4" DR. 13-Surface drive socket 4; 4.5; 5; 5.5; 6; 7; 8; 9; 10; 11; 12; 13; 14 mm | | |
| 80229 | 1-72 teeth ratchet handle | | |
| 8042 050...150 | 2-Extension bar 2"; 6" | | |
| 80521 | 1-Universal joint | | |
| 8032115 | 1-Sliding T handle | | |
| 8145 | 1-Spinner | | |

| 2203-72-5 | | | |
|------------------------------|---|-----------------|------|
| Part no. | Socket | 15/14.0/15.0/1' | 934g |
| Changed Items 525 04...14 | Content: 1/4" DR. 13-6pt. Flank socket 4; 4.5; 5; 5.5; 6; 7; 8; 9; 10; 11; 12; 13; 14 mm | | |

NEW



12 sets / display box

22pc 1/4" Socket and bit set

| 2222 | | | |
|----------------|--|-----------------------|------------|
| Part no. | Socket | 12/48/13.4/14.4/0.87' | 280g/3550g |
| 12125 1...3 | Content: 1/4" DR. 15-1/4" bit (25mmL) PH.1; PH.2; PH.3 | | |
| 12325 04...065 | Slotted 4; 5.5; 6.5 mm | | |
| 12425 03...06 | Hex 3; 4; 5; 6 mm | | |
| 12625 10...30 | Star T10; T15; T20; T25; T30 | | |
| 525 06...13 | 5-1/4"DR. 6pt. Flank socket 6; 7; 8; 10; 13 mm | | |
| 8092225 | 1-Bit adaptor 1/4"Hex-1/4" Sq. (25mmL) | | |
| 802214 | 1-Bit ratchet 1/4" inhex | | |



24pc 1/4" Socket set

| 2253 | | | |
|----------------|--|-----------------|-------|
| Part no. | Socket | 15/15.5/16.5/1' | 1033g |
| 525 04...13 | Content: 1/4" DR. 11-6pt. Flank socket 4; 5; 5.5; 6; 7; 8; 9; 10; 11; 12; 13 mm | | |
| 52550 05...13 | 9-6pt. Flank deep socket 5; 6; 7; 8; 9; 10; 11; 12; 13 mm | | |
| 80225 | 1-Ratchet handle | | |
| 8042 050...150 | 2-Extension bar 2"; 6" | | |
| 8143 | 1-Spinner | | |



24pc 1/4" Socket set

| 2253-72 | | | |
|----------------|--|-----------------|-------|
| Part no. | Socket | 15/15.5/16.5/1' | 1033g |
| 525 04...13 | Content: 1/4" DR. 11-6pt. Flank socket 4; 5; 5.5; 6; 7; 8; 9; 10; 11; 12; 13 mm | | |
| 52550 05...13 | 9-6pt. Flank deep socket 5; 6; 7; 8; 9; 10; 11; 12; 13 mm | | |
| 80229 | 1-72 teeth ratchet handle | | |
| 8042 050...150 | 2-Extension bar 2"; 6" | | |
| 8143 | 1-Spinner | | |

NEW



25pc 1/4"DR. Ratchet spinner set

| 2255 | | |
|----------------|--|------|
| Part no. | 40/15.6/16.6/3.2' | 370g |
| 81022M | Content: 1/4"DR. 1-Magnetic bit holder 1 4"(F) x 1/4" inhex | |
| 8149 | 1-Ratchet spinner 23-1/4" bit (25mmL) | |
| 12125 1...3 | Phillips PH.1; PH.2; PH.3 | |
| 12225 1...3 | Pozidriv PZ1; PZ.2; PZ.3 | |
| 12325 03...065 | Slotted 3; 4; 5; 5.5; 6.5 mm | |
| 12425 03...08 | Hex 3; 4; 5; 6; 7; 8 mm | |
| 12725 10...30 | Star tamperproof T-10H; T-15H; T-20H; T-25H; T-27H; T-30H | |

NEW



26pc 1/4" DR. Ratchet bit driver set

| 2263 | | | |
|-------------------|--|-----------------|-------|
| Part no. | Socket | 10/14.0/15.0/1' | 1400g |
| 121D 12...34 | Content: 1/4"DR. 12-1/4" Double-sized bit (165mmL) Phillips PH.1xPH.2; PH.3xPH.4 | | |
| 122D 12...34 | Pozidriv PZ.1xPZ.2; PZ.3xPZ.4 | | |
| 123D 0304...05507 | Slotted 3x4mm; 5.5x7mm | | |
| 124D 0304...0506 | Hex 3x4mm; 5x6mm | | |
| 126D 0810...3040 | Star T8xT10; T15xT20; T25xT27; T30xT40 | | |
| 525 04...12 | 11-1/4"DR. 6pt. Flank socket 4; 4.5; 5; 5.5; 6; 7; 8; 9; 10; 11; 12mm | | |
| 80922 | 1-Adapter 1/4" inhex*1/4"(M) | | |
| 8152R | 1-Ratchet bit driver handle | | |
| 88601 | 1-Demagnetizer/Magnetizer | | |



27pc 1/4" Socket combination set

| Part no. | Socket | 15/14.8/15.8/1' | 986g |
|----------------|--|-----------------|------|
| 2281 | | | |
| 529 04...14 | Content: 1/4" DR. 11-12pt. Flank socket 4; 5; 6; 7; 8; 9; 10; 11; 12; 13; 14 mm | | |
| 32432 03...06 | 10-Socket bit (32mmL) Hex 3; 4; 5; 6 mm | | |
| 32332 04...07 | Slotted 4; 5.5; 7 mm | | |
| 32132 1...3 | Phillips PH.1; PH.2; PH.3 | | |
| 80222 | 1-Ratchet handle | | |
| 8042 050...150 | 2-Extension bar 2"; 6" | | |
| 8032115 | 1-Sliding T handle | | |
| 80521 | 1-Universal joint | | |
| 8143 | 1-Spinner | | |

27pc 1/4" Socket combination set

| Part no. | Socket | 15/14.8/15.8/1' | 986g |
|----------------|--|-----------------|------|
| 2281-72 | | | |
| 529 04...14 | Content: 1/4" DR. 11-12pt. Flank socket 4; 5; 6; 7; 8; 9; 10; 11; 12; 13; 14 mm | | |
| 32432 03...06 | 10-Socket bit (32mmL) Hex 3; 4; 5; 6 mm | | |
| 32332 04...07 | Slotted 4; 5.5; 7 mm | | |
| 32132 1...3 | Phillips PH.1; PH.2; PH.3 | | |
| 80229 | 1-72 teeth ratchet handle | | |
| 8042 050...150 | 2-Extension bar 2"; 6" | | |
| 8032115 | 1-Sliding T handle | | |
| 80521 | 1-Universal joint | | |
| 8143 | 1-Spinner | | |

2281-5

| Part no. | Socket | 15/14.8/15.8/1' | 986g |
|-------------|---|-----------------|------|
| 525 04...14 | Content: 1/4" DR. 11-6pt. Flank socket 4; 5; 6; 7; 8; 9; 10; 11; 12; 13; 14 mm | | |

2281-72-5

| Part no. | Socket | 15/14.8/15.8/1' | 986g |
|-------------|---|-----------------|------|
| 525 04...14 | Content: 1/4" DR. 11-6pt. Flank socket 4; 5; 6; 7; 8; 9; 10; 11; 12; 13; 14 mm | | |

2281S NEW

| Part no. | Socket | 15/14.8/15.8/1' | 986g |
|------------------|--|-----------------|------|
| 529 5.32...9.16 | Content: 1/4" DR. 11-12pt. Flank Socket 5/32", 3/16", 7/32", 1/4", 9/32", 5/16"; 11/32", 3/8", 7/16", 1/2", 9/16" | | |
| 32432 1.8...7.32 | 4-Hex socket bit 1/8", 5/32", 3/16", 7/32" (32mmL) | | |

29pc 1/4" Socket combination set

| Part no. | Socket | 20/14.8/15.8/1' | 740g |
|---------------|---|-----------------|------|
| 2292 | | | |
| 525 04...13 | Content: 1/4" DR. 12-6pt. Flank socket 4; 4.5; 5; 5.5; 6; 7; 8; 9; 10; 11; 12; 13 mm | | |
| 32432 03...08 | 12-Socket bit 25mmL (one-piece) Hex 3; 4; 5; 6; 8 mm | | |
| 32332 04...07 | Slotted 4; 5.5; 7 mm | | |
| 32132 01...02 | Phillips PH.1; PH.2 | | |
| 32232 01...02 | Pozidriv PZ.1; PZ.2 | | |
| 80222 | 1-Ratchet handle | | |
| 8032115 | 1-Sliding T handle | | |
| 8042050 | 1-Extension bar 2" | | |
| 80521 | 1-Universal joint | | |
| 8143 | 1-Spinner 6" | | |

2292-7

| Part no. | Socket | 20/14.8/15.8/1' | 740g |
|-------------|---|-----------------|------|
| 527 04...13 | Content: 1/4" DR. 12- Surface drive socket 4; 4.5; 5; 5.5; 6; 7; 8; 9; 10; 11; 12; 13 mm | | |

2292-9

| Part no. | Socket | 20/14.8/15.8/1' | 740g |
|-------------|--|-----------------|------|
| 529 04...13 | Content: 1/4" DR. 12-12pt. Flank socket 4; 4.5; 5; 5.5; 6; 7; 8; 9; 10; 11; 12; 13 mm | | |

29pc 1/4" Star set

| Part no. | Socket | 10/16.5/17.5/0.7' | 1650g |
|-----------------|--|-------------------|-------|
| 2303 | | | |
| 526 05...08 | Content: 1/4" & 3/8" & 1/2" DR. 10-Star socket 1/4"DR.: E5; E6; E7; E8 | | |
| 536 10...14 | 3/8"DR.: E10; E12; E14 | | |
| 546 16...20 | 1/2"DR.: E16; E18; E20 | | |
| 12625 10...30 | 5-1/4" Star bit (25mmL) T10; T20; T25; T27; T30 | | |
| 15635 40...50 | 3-5/16" Star bit (35mmL) T40; T45; T50 | | |
| 346055 55...60 | 2-1/2"DR. Star socket bit T55; T60 (55mmL) | | |
| 1266525 | 1-1/4" Star bit T25 (65mmL) | | |
| 1273030G | 1-1/4" Star tamperproof bit T-30H (30mmL) | | |
| 756 0608...2024 | 4-Star wrench E6xE8; E10xE12; E14xE18; E20xE24 | | |
| 81022 | 1-Bit holder 1/4"DR.x1/4" | | |
| 81035 | 1-Bit holder 3/8"DR.x5/16" | | |
| 81045 | 1-Bit holder 1/2"DR.x5/16" | | |

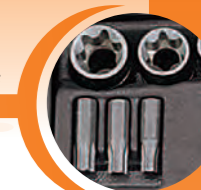

31pc 1/4" Socket set

| 2312 | | | |
|-------------------|--|-----------------|-------|
| Part no. | Socket | 15/19.3/20.3/1' | 1360g |
| Content: 1/4" DR. | | | |
| 529 04...14 | 13-12pt. Flank socket (MM) 4; 4.5; 5; 5.5; 6; 7; 8; 9; 10; 11; 12; 13; 14 mm | | |
| 529 3.16...9.16 | 10-12pt. Flank socket (SAE) 3/16"; 7/32"; 1/4"; 9/32"; 5/16"; 11/32"; 3/8"; 7/16"; 1/2"; 9/16" | | |
| 80222 | 1-Ratchet handle | | |
| 8042 050...150 | 2-Extension bar 2"; 6" | | |
| 80622 | 1-Adaptor for extension 1/4"(F)x1/4"(M) | | |
| 80521 | 1-Universal joint | | |
| 8145 | 1-Spinner | | |
| 81022 | 1-Bit holder 1/4"DR.x1/4" | | |
| 8111 | 1-Flexible extension | | |

| 2312-5 | | | |
|-------------------|--|-----------------|-------|
| Part no. | Socket | 15/19.3/20.3/1' | 1360g |
| Content: 1/4" DR. | | | |
| 525 04...14 | 13- 6pt. Flank socket (MM) 4; 4.5; 5; 5.5; 6; 7; 8; 9; 10; 11; 12; 13; 14 mm | | |
| 525 3.16...9.16 | 10- 6pt. Flank socket (SAE) 3/16"; 7/32"; 1/4"; 9/32"; 5/16"; 11/32"; 3/8"; 7/16"; 1/2"; 9/16" | | |

31pc 1/4" Socket set

| 2312-72 | | | |
|-------------------|--|-------------|-------|
| Part no. | Socket | 15/16/17/1' | 1066g |
| Content: 1/4" DR. | | | |
| 529 04...14 | 13-12pt. Flank socket (MM) 4; 4.5; 5; 5.5; 6; 7; 8; 9; 10; 11; 12; 13; 14 mm | | |
| 529 3.16...9.16 | 10-12pt. Flank socket (SAE) 3/16"; 7/32"; 1/4"; 9/32"; 5/16"; 11/32"; 3/8"; 7/16"; 1/2"; 9/16" | | |
| 80229 | 1-72 teeth ratchet handle | | |
| 8042 050...150 | 2-Extension bar 2"; 6" | | |
| 80622 | 1-Adaptor for extension 1/4"(F)x1/4"(M) | | |
| 80521 | 1-Universal joint | | |
| 8145 | 1-Spinner | | |
| 81022 | 1-Bit holder 1/4"DR.x1/4" | | |
| 8111 | 1-Flexible extension | | |

| 2312-72-5 | | | |
|-------------------|--|-------------|-------|
| Part no. | Socket | 15/16/17/1' | 1066g |
| Content: 1/4" DR. | | | |
| 525 04...14 | 13- 6pt. Flank socket (MM) 4; 4.5; 5; 5.5; 6; 7; 8; 9; 10; 11; 12; 13; 14 mm | | |
| 525 3.16...9.16 | 10- 6pt. Flank socket (SAE) 3/16"; 7/32"; 1/4"; 9/32"; 5/16"; 11/32"; 3/8"; 7/16"; 1/2"; 9/16" | | |

31pc 1/4" Bit set

| 2313 | | |
|-----------------|--|------|
| Part no. | 48/14.4/15.4/1.2' | 300g |
| Content: 1/4" | | |
| 12125 0...3 | 6-1/4" Phillips bit (25mmL) PH.0 x 1pc; PH.1 x 2pc; PH.2 x 2pc; PH.3 x 1pc | |
| 12225 1...3 | 5-1/4" Pozidriv bit (25mmL) PZ.1 x 2pc; PZ.2 x 2pc; PZ.3 x 1pc | |
| 12325 055...065 | 3-1/4" Slotted bit 4; 5.5; 6.5 mm (25mmL) | |
| 12425 03...06 | 4-1/4" Hex bit 3; 4; 5; 6 mm (25mmL) | |
| 12625 05...40 | 12-1/4" Star bit T5; T6; T7; T8; T9; T10; T15; T20; T25; T27; T30; T40 (25mmL) | |
| 81260Q | 1-Magnetic quick-release bit holder | |

31pc 1/4" Bit set

| 2314A | | |
|----------------|--|------|
| Part no. | 48/14.4/15.4/1.2' | 300g |
| Content: 1/4" | | |
| 12125 1...3 | 10-1/4" Phillips bit (25mmL) PH.1 x 2pc; PH.2 x 5pc; PH.3 x 3pc | |
| 12225 1...3 | 10-1/4" Pozidriv bit (25mmL) PZ.1 x 2pc; PZ.2 x 5pc; PZ.3 x 3pc | |
| 12325 04...065 | 10-1/4" Slotted bit (25mmL) 4 x 2pc; 5.5 x 5pc; 6.5 x 3pc | |
| 81260Q | 1-Magnetic quick-release bit holder | |



31pc 1/4" Bit set

| 2314B | | |
|----------------|--|------|
| Part no. | 48/14.4/15.4/1.2' | 300g |
| Content: 1/4" | | |
| 12125 1...3 | 10-1/4" Phillips bit (25mmL) PH.1 x 2pc; PH.2 x 5pc; PH.3 x 3pc | |
| 12225 1...3 | 10-1/4" Pozidriv bit (25mmL) PZ.1 x 2pc; PZ.2 x 5pc; PZ.3 x 3pc | |
| 12325 04...065 | 10-1/4" Slotted bit (25mmL) 4 x 2pc; 5.5 x 5pc; 6.5 x 3pc | |
| 81280Q | 1-Magnetic quick-release holder with screw steady * 81280Q with a second magnet to keep screws always straight and centered. | |

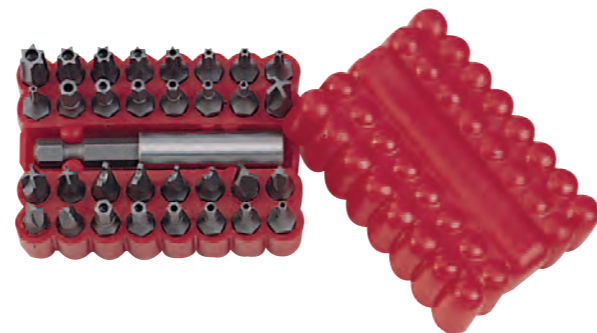

31pc 1/4" Bit set

| 2315 | | |
|-----------------|---|------|
| Part no. | 48/14.4/15.4/1.2' | 300g |
| Content: 1/4" | | |
| 121S25 06...1.4 | 4-1/4" Torq set bit (25mmL) 6; 8; 10; mm 1/4" | |
| 122S25 01...03 | 3-1/4" Tri-wing bit (25mmL) PH.1; PH.2; PH.3 | |
| 123S25 04...10 | 4-1/4" Spanner bit (25mmL) 4; 6; 8; 10 mm | |
| 124S25 02...06 | 6-1/4" Hex security bit (25mmL) 2; 2.5; 3; 4; 5; 6 mm | |
| 12725 07...40 | 9-1/4" Star tamperproof bit (25mmL) T-7H; T-8H; T-10H; T-15H; T-20H; T-25H; T-27H; T-30H; T-40H | |
| 124R25 0...3 | 4-1/4" Square bit (25mmL) No.0; No.1; No.2; No.3 | |
| 81260Q | 1-Magnetic quick-release bit holder | |

33pc 1/4" Security bit set

| 2331 | | |
|----------------|---|------|
| Part no. | 80/20.0/21.0/1.6' | 250g |
| Content: 1/4" | | |
| 81260 | 1-Magnetic bit holder (60mmL) 32-1/4" Security bit (25mmL) | |
| 121S25 06...10 | Torq set 6; 8; 10 | |
| 122S25 01...04 | Tri-wing 1; 2; 3; 4 | |
| 123S25 04...10 | Spanner 4; 6; 8; 10 | |
| 124S25 02...06 | Hex security 2; 2.5; 3; 4; 5; 6 mm 5/32"; 9/64"; 1/8"; 7/64"; 3/32"; 5/64" | |
| 12725 08...40 | Star tamperproof T-8H; T-10H; T-15H; T-20H; T-25H; T-27H; T-30H; T-35H; T-40H | |

40pc 1/4" Socket set

| 2402 | | | |
|-------------------|--|-----------------|-------|
| Part no. | Socket | 10/15.4/16.4/1' | 1540g |
| Content: 1/4" DR. | | | |
| 525 04...13 | 18-6pt. Flank socket 4; 4.5; 5; 5.5; 6; 7; 8; 9; 10; 11; 12; 13 mm | | |
| 525 3.16...1.2 | 3/16"; 1/4"; 9/32"; 11/32"; 3/8"; 1/2" | | |
| 52550 04...13 | 14-6pt. Flank deep socket 4; 5; 5.5; 6; 7; 8; 9; 10; 11; 13 mm | | |
| 52550 3.16...1.2 | 3/16"; 1/4"; 3/8"; 1/2" | | |
| 80225 | 1-Ratchet handle | | |
| 8042 050...150 | 3-Extension bar 2"; 4"; 6" | | |
| 8111 | 1-Flexible extension | | |
| 8032115 | 1-Sliding T handle | | |
| 80521 | 1-Universal joint | | |
| 8143 | 1-Spinner | | |

40pc 1/4" Spline combination set

| 2405Q | | | |
|-------------------|--|-----------------|------|
| Part no. | Socket | 15/14.5/15.5/1' | 967g |
| Content: 1/4" DR. | | | |
| 52Q 04...14 | 13-Spline socket 4; 4.5; 5; 5.5; 6; 7; 8; 9; 10; 11; 12; 13; 14 mm | | |
| 12125 1...2 | 22-1/4" bit (25mmL) Phillips PH.1; PH.2 | | |
| 12225 1...2 | Pozidriv PZ.1; PZ.2 | | |
| 12425 03...08 | Hex 3; 4; 5; 6; 7; 8 mm | | |
| 12625 10...40 | Star T10; T15; T20; T25; T27; T30; T40 | | |
| 12825 04...10 | Spline M4; M5; M6; M8; M10 | | |
| 80222 | 1-Ratchet handle | | |
| 8042100 | 1-Extension bar (100mmL) | | |
| 80521 | 1-Universal joint | | |
| 81022 | 1-Bit holder 1/4"(F)x1/4"(F) | | |
| 8143 | 1-Spinner 6" | | |



NEW



1/4" DR. Socket combination set

| Part no. | Socket | 12/13.2/14.2/1.4' | 1130g |
|-------------------|---------------------------------------|---------------------------------------|-------|
| K2413 | | | |
| Content: 1/4" DR. | | | |
| 525 05...13 | 10-6pt. Flank socket | 5; 5.5; 6; 7; 8; 9; 10; 11; 12; 13 mm | |
| | 21-1/4" bit (30mmL) | | |
| 12130 1...3 | Phillips PH.1; PH.2; PH.3 | | |
| 12230 1...3 | Pozidriv PZ.1; PZ.2; PZ.3 | | |
| 12330 04...065 | Slotted 4; 5.5; 6; 6.5 mm | | |
| 12430 03...07 | Hex 3; 4; 5; 6; 7 mm | | |
| 12630 10...40 | Star T10; T15; T20; T25; T30; T40 | | |
| 802220 | 1-T mini ratchet | | |
| 8042 075W, 150W | 2-Wobble extension 75mm & 150mm | | |
| 755S 08...14 | 5-Midget combination wrench | 8; 10; 12; 13; 14 mm | |
| 81022M | 1-Magnetic bit Holder | 1/4"(F)x1/4"inhex | |
| 8148 | 1-Quick-release bit spinner 1/4"inhex | | |

42pc 1/4" Socket combination set

| Part no. | Socket | 20/18.0/19.0/0.82 | 900g |
|-------------------|-----------------------------------|--|------|
| 2421 | | | |
| Content: 1/4" DR. | | | |
| 525 032...14 | 14-6pt. Flank socket | 3.2; 4; 4.5; 5; 5.5; 6; 7; 8; 9; 10; 11; 12; 13; 14 mm | |
| | 20-1/4" bit (25mmL) | | |
| 12425 03...08 | Hex 3, 4, 5, 6, 8 mm | | |
| 12625 10...40 | Star T10, T15, T20, T25, T30, T40 | | |
| 12325 04...065 | Slotted 4, 5.5, 6.5 mm | | |
| 12125 1...3 | Phillips PH.1, PH.2, PH.3 | | |
| 12225 1...3 | Pozidriv PZ.1, PZ.2, PZ.3 | | |
| 80229 | 1-72 teeth ratchet handle | | |
| 8042 050...150 | 2-Extension bar 2"; 6" | | |
| 80521 | 1-Universal joint | | |
| 81022 | 1-Bit holder 1/4"(F)x1/4"(F) | | |
| 8143 | 1-Spinner | | |
| 80632 | 1-Adaptor for extension | 3/8"(F)x1/4"(M) | |
| 81225 | 1-Magnetic socket pick up | | |

42pc 1/4" Socket combination set

| Part no. | Socket | 20/18.0/19.0/0.82 | 900g |
|-------------------|-----------------------------------|--|------|
| 2421F | | | |
| Content: 1/4" DR. | | | |
| 525 032...14 | 14-6pt. Flank socket | 3.2; 4; 4.5; 5; 5.5; 6; 7; 8; 9; 10; 11; 12; 13; 14 mm | |
| | 20-1/4" bit (25mmL) | | |
| 12425 03...08 | Hex 3, 4, 5, 6, 8 mm | | |
| 12625 10...40 | Star T10, T15, T20, T25, T30, T40 | | |
| 12325 04...065 | Slotted 4, 5.5, 6.5 mm | | |
| 12125 1...3 | Phillips PH.1, PH.2, PH.3 | | |
| 12225 1...3 | Pozidriv PZ.1, PZ.2, PZ.3 | | |
| 802218 | 1-Flexible ratchet handle | | |
| 8042 050...150 | 2-Extension bar 2"; 6" | | |
| 80521 | 1-Universal joint | | |
| 81022 | 1-Bit holder 1/4"(F)x1/4"(F) | | |
| 8143 | 1-Spinner | | |
| 80632 | 1-Adaptor for extension | 3/8"(F)x1/4"(M) | |
| 81225 | 1-Magnetic socket pick up | | |

42pc 1/4" Socket combination set

| Part no. | Socket | 20/18.0/19.0/0.82 | 900g |
|-------------------|---------------------------------------|--|------|
| 2421BF | | | |
| Content: 1/4" DR. | | | |
| 525 032...14 | 14-6pt. Flank socket | 3.2; 4; 4.5; 5; 5.5; 6; 7; 8; 9; 10; 11; 12; 13; 14 mm | |
| | 20-1/4" bit (25mmL) | | |
| 12425 03...08 | Hex 3, 4, 5, 6, 8 mm | | |
| 12625 10...40 | Star T10, T15, T20, T25, T30, T40 | | |
| 12325 04...065 | Slotted 4, 5.5, 6.5 mm | | |
| 12125 1...3 | Phillips PH.1, PH.2, PH.3 | | |
| 12225 1...3 | Pozidriv PZ.1, PZ.2, PZ.3 | | |
| 802202F | 1-Flexible bit ratchet for 1/4" inhex | | |
| 8042 050...150 | 2-Extension bar 2"; 6" | | |
| 80521 | 1-Universal joint | | |
| 8092225 | 1-Bit adaptor 1/4"Hex-1/4" Sq. | | |
| 8143 | 1-Spinner | | |
| 80632 | 1-Adaptor for extension | 3/8"(F)x1/4"(M) | |
| 81225 | 1-Magnetic socket pick up | | |



46pc 1/4" Socket combination set

| 2461 | | | |
|-----------------------|-----------------------------------|---|-------|
| Part no. | Socket | 10/13/14/1.3' | 1300g |
| Content: 1/4" DR. | | | |
| 527 04...14 | 13-Surface drive socket | 4; 4.5; 5; 5.5; 6; 7; 8; 9; 10; 11; 12; 13; 14 mm | |
| 52750 08...13 | 4-Surface drive deep socket | 8; 10; 12; 13 (50mmL) | |
| 20-Socket bit (32mmL) | | | |
| 32432 03...08 | Hex 3; 4; 5; 6; 8 mm | | |
| 32632 10...40 | Star T10; T15; T20; T25; T30; T40 | | |
| 32332 04...065 | Slotted 4; 5.5; 6.5 mm | | |
| 32132 1...3 | Phillips PH.1; PH.2; PH.3 | | |
| 32232 1...3 | Pozidriv PZ.1; PZ.2; PZ.3 | | |
| 80222 | 1-Ratchet handle | | |
| 8042 050...100 | 2-Extension bar 2"; 4" | | |
| 8032115 | 1-Sliding T handle | | |
| 80521 | 1-Universal joint | | |
| 8143 | 1-Spinner | | |
| 764-3 | 3-Hex key 1.5; 2; 2.5 mm | | |

| 2461-5 | | | |
|-------------------|--------------------------|---|-------|
| Part no. | Socket | 10/13/14/1.3' | 1300g |
| Content: 1/4" DR. | | | |
| 525 04...14 | 13-6pt. Flank socket | 4; 4.5; 5; 5.5; 6; 7; 8; 9; 10; 11; 12; 13; 14 mm | |
| 52550 08...13 | 4-6pt. Flank deep socket | 8; 10; 12; 13 (50mmL) | |



46pc 1/4" Socket combination set

| 2462 | | | |
|-----------------------|---------------------------------------|---|-------|
| Part no. | Socket | 10/12.5/13.5/0.8' | 1250g |
| Content: 1/4" DR. | | | |
| 525 04...14 | 13-6pt. Flank socket | 4; 4.5; 5; 5.5; 6; 7; 8; 9; 10; 11; 12; 13; 14 mm | |
| 22-Socket bit (32mmL) | | | |
| 32432 03...08 | Hex 3; 4; 5; 6; 7; 8 mm | | |
| 32632 08...40 | Star T8; T10; T15; T20; T25; T30; T40 | | |
| 32332 04...07 | Slotted 4; 5.5; 7 mm | | |
| 32132 1...3 | Phillips PH.1; PH.2; PH.3 | | |
| 32232 1...3 | Pozidriv PZ.1; PZ.2; PZ.3 | | |
| 80222 | 1-Ratchet handle | | |
| 8042 050...100 | 2-Extension bar 2"; 4" | | |
| 8032115 | 1-Sliding T handle | | |
| 8111 | 1-Flexible extension | | |
| 80521 | 1-Universal joint | | |
| 8143 | 1-Spinner | | |
| 764-4 | 4-Hex key 1.27; 1.5; 2; 2.5 mm | | |

| 2462-7 | | | |
|-------------------|-------------------------|---|-------|
| Part no. | Socket | 10/12.5/13.5/0.8' | 1250g |
| Content: 1/4" DR. | | | |
| 527 04...14 | 13-Surface drive socket | 4; 4.5; 5; 5.5; 6; 7; 8; 9; 10; 11; 12; 13; 14 mm | |

| 2462-9 | | | |
|-------------------|-----------------------|---|-------|
| Part no. | Socket | 10/12.5/13.5/0.8' | 1250g |
| Content: 1/4" DR. | | | |
| 529 04...14 | 13-12pt. Flank socket | 4; 4.5; 5; 5.5; 6; 7; 8; 9; 10; 11; 12; 13; 14 mm | |

NEW



46pc 1/4"DR. Ratchet spinner set

| K2463 | | | |
|---------------------|--|---|------|
| Part no. | Socket | 24/17.8/18.8/1.5' | 740g |
| Content: 1/2"DR. | | | |
| 52Q 04...14 | 13-Spline socket | 4; 4.5; 5; 5.5; 6; 7; 8; 9; 10; 11; 12; 13; 14 mm | |
| 31-1/4" bit (25mmL) | | | |
| 12125 0...3 | Phillips PH.0; PH.1; PH.2; PH.3 | | |
| 12225 0...3 | Pozidriv PZ.0; PZ.1; PZ.2; PZ.3 | | |
| 12325 03...065 | Slotted 3; 4; 5; 5.5; 6.5 mm | | |
| 12425 03...08 | Hex 3; 4; 5; 6; 7; 8 mm | | |
| 12725 10...40 | Star tamperproof T-10H; T-15H; T-20H; T-25H; T-27H; T-30H; T-40H | | |
| 12825 04...10 | Spline M4; M5; M6; M8; M10 | | |
| 81022M | 1-Magnetic bit holder 1/4"(F)x1/4(F) | | |
| 8149 | 1-Ratchet spinner | | |



50pc 1/4" Combination set

| 2502 | | | |
|-----------------------|--|---|-------|
| Part no. | Socket | 10/14.7/15.7/1' | 1500g |
| Content: 1/4" DR. | | | |
| 525 04...14 | 13-6pt. Flank socket | 4; 4.5; 5; 5.5; 6; 7; 8; 9; 10; 11; 12; 13; 14 mm | |
| 52550 08...13 | 4-6pt. Flank deep socket | 8; 10; 12; 13 mm | |
| 23-Socket bit (32mmL) | | | |
| 32432 03...08 | Hex 3; 4; 5; 6; 7; 8 mm | | |
| 32132 1...3 | Phillips PH.1; PH.2; PH.3 | | |
| 32232 1...3 | Pozidriv PZ.1; PZ.2; PZ.3 | | |
| 32332 04...065 | Slotted 4; 5.5; 6.5 mm | | |
| 32632 08...40 | Star T8; T10; T15; T20; T25; T27; T30; T40 | | |
| 80229 | 1-72 teeth ratchet handle | | |
| 8042 050...100 | 2-Extension bar 2"; 4" | | |
| 8032115 | 1-Sliding T handle | | |
| 80521 | 1-Universal joint | | |
| 8143 | 1-Spinner | | |
| 764-4 | 4-Hex key 1.27; 1.5; 2; 2.5 | | |

| 2502-7 | | | |
|-------------------|-----------------------------|---|-------|
| Part no. | Socket | 10/14.7/15.7/1' | 1500g |
| Content: 1/4" DR. | | | |
| 527 04...14 | 13-Surface drive socket | 4; 4.5; 5; 5.5; 6; 7; 8; 9; 10; 11; 12; 13; 14 mm | |
| 52750 08...13 | 4-Surface drive deep socket | 8; 10; 12; 13 mm | |

| 2502-9 | | | |
|-------------------|---------------------------|---|-------|
| Part no. | Socket | 10/14.7/15.7/1' | 1500g |
| Content: 1/4" DR. | | | |
| 529 04...14 | 13-12pt. Flank socket | 4; 4.5; 5; 5.5; 6; 7; 8; 9; 10; 11; 12; 13; 14 mm | |
| 52950 08...13 | 4-12pt. Flank deep socket | 8; 10; 12; 13 mm | |



57pc 1/4" Combination set

| Part no. | Socket | 15/21.0/22.0/1' | 1400g |
|-----------------------|--|---|-------|
| 2571 | | | |
| Content: 1/4" DR. | | | |
| 525 04...14 | 13-6pt. Flank socket | 4; 4.5; 5; 5.5; 6; 7; 8; 9; 10; 11; 12; 13; 14 mm | |
| 52550 06...10 | 4-6pt. Flank deep socket | 6; 7; 8; 10 mm | |
| 24-Socket bit (32mmL) | | | |
| 32132 1...3 | Phillips PH.1; PH.2; PH.3 | | |
| 32232 1...3 | Pozidriv PZ.1; PZ.2; PZ.3 | | |
| 32332 04...065 | Slotted 4; 5.5; 6.5 mm | | |
| 32432 03...10 | Hex 3; 4; 5; 6; 7; 8; 10 mm | | |
| 32632 08...40 | Star T8; T10; T15; T20; T25; T27; T30; T40 | | |
| 526 04...10 | 6-Star socket | E4; E5; E6; E7; E8; E10 | |
| 80229 | 1-72 teeth ratchet handle | | |
| 8032115 | 2-Sliding T handle | | |
| 8042 050...100 | 1-Extension bar 2"; 4" | | |
| 80521 | 1-Universal joint | | |
| 8143 | 1-Spinner | | |
| 764-4 | 4-Hex key 1.27; 1.5; 2; 2.5 mm | | |

NEW



59pc 1/4" DR. Ratchet spinner & tool set

| Part no. | Socket | 10/15.4/16.4/1.4' | 1540g |
|---------------------|---|---|-------|
| 2591 | | | |
| Content: 1/4" DR. | | | |
| 529 04...14 | 13-12pt. Flank socket | 4; 4.5; 5; 5.5; 6; 7; 8; 9; 10; 11; 12; 13; 14 mm | |
| 34-1/4" bit (25mmL) | | | |
| 12125 0...3 | Phillips PH.0; PH.1; PH.2; PH.3 | | |
| 12225 0...3 | Pozidriv PZ.0; PZ.1; PZ.2; PZ.3 | | |
| 12325 03...065 | Slotted 3; 4; 5; 5.5; 6.5 mm | | |
| 12425 015...10 | Hex 1.5; 2; 2.5; 3; 4; 5; 5.5; 6; 7; 8; 10 mm | | |
| 12625 08...40 | Star T8; T9; T10; T15; T20; T25; T27; T30; T35; T40 | | |
| 610150 | 1-Long Nose pliers 6" | | |
| 611150 | 1-Combination pliers | | |
| 6945140 | 1-Z-shaped needle-tip 140mmL | | |
| 6982 | 1-Technician's scissors 145mmL | | |
| 733040018 | 1-Slotted jeweler screwdriver 1.8 mm | | |
| 731040000 | 1-Phillips jeweler screwdriver PH.000 | | |
| 8032115 | 1-Sliding T handle | | |
| 8042050W | 1-1/4" Wobble extension 2" | | |
| 8042100 | 1-Extension 4" | | |
| 80521 | 1-Universal joint | | |
| 81022M | 1-Magnetic bit holder 1/4"(F) x 1/4(F) | | |
| 8149 | 1-Ratchet spinner | | |



61pc 1/4" bit set

| Part no. | 30/16.1/17.1/0.98' | 520g |
|----------------|-------------------------------------|-----------------------------------|
| 2611A | | |
| Content: 1/4" | | |
| 12125 1...3 | 23-Phillips bit (25mmL) | PH.1x7pc; PH.2x13pc; PH.3x3pc |
| 12225 1...3 | 23-Pozidriv bit (25mmL) | PZ.1x7pc; PZ.2x13pc; PZ.3x3pc |
| 12325 04...065 | 3-Slotted bit (25mmL) | 4; 5.5; 6.5 mm |
| 12425 03...06 | 4-Hex bit (25mmL) | 3; 4; 5; 6 mm |
| 12625 10...40 | 7-Star bit (25mmL) | T10; T15; T20; T25; T27; T30; T40 |
| 81260Q | 1-Magnetic quick-release bit holder | |



61pc 1/4" bit set

| Part no. | 30/16.1/17.1/0.98' | 520g |
|--|---|-----------------------------------|
| 2611B | | |
| Content: 1/4" | | |
| 12125 1...3 | 23-Phillips bit (25mmL) | PH.1x7pc; PH.2x13pc; PH.3x3pc |
| 12225 1...3 | 23-Pozidriv bit (25mmL) | PZ.1x7pc; PZ.2x13pc; PZ.3x3pc |
| 12325 04...065 | 3-Slotted bit (25mmL) | 4; 5.5; 6.5 mm |
| 12425 03...06 | 4-Hex bit (25mmL) | 3; 4; 5; 6 mm |
| 12625 10...40 | 7-Star bit (25mmL) | T10; T15; T20; T25; T27; T30; T40 |
| 81280Q | 1-Magnetic quick-release holder with screw steady | |
| *81280Q with a second magnet to keep screws always straight and centered | | |

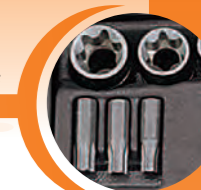

65pc 1/4" Socket combination set

| Part no. | Socket | 6/15.0/16.0/0.9' | 2500g |
|-----------------------|--|--|-------|
| 2641 | | | |
| Content: 1/4" DR. | | | |
| 525 032...14 | 14-6pt. Flank socket | 3.2; 4; 4.5; 5; 5.5; 6; 7; 8; 9; 10; 11; 12; 13; 14 mm | |
| 52550 05...13 | 9-6pt. Flank deep socket | 5; 6; 7; 8; 9; 10; 11; 12; 13 mm | |
| 24-Socket bit (32mmL) | | | |
| 32432 03...10 | Hex 3; 4; 5; 6; 7; 8; 10 mm | | |
| 32132 1...3 | Phillips PH.1; PH.2; PH.3 | | |
| 32232 1...3 | Pozidriv PZ.1; PZ.2; PZ.3 | | |
| 32332 04...065 | Slotted 4; 5.5; 6.5 mm | | |
| 32632 08...40 | Star T8; T10; T15; T20; T25; T27; T30; T40 | | |
| 80229 | 1-72 teeth ratchet handle | | |
| 8042 050...150 | 1-Extension bar 2"; 4"; 6" | | |
| 8032115 | 1-Sliding T handle | | |
| 80521 | 1-Universal joint | | |
| 8143 | 1-Spinner 6" | | |
| 81225 | 1-Magnetic socket pick-up | | |
| 5102XLB | 10 pc Hex ball point long key set | | |
| 7650127XL... | 1.27; 1.5; 2; 2.5; 3; 4; 5; 6; 8; | | |
| 10XL | 10 mm | | |

74pc 1/4" Socket combination set

| Part no. | Socket | 6/14.2/15.2/0.9 | 1840g |
|---------------------------|---|---|-------|
| 2741 | | | |
| Content: 1/4" DR. | | | |
| 525 04...13 | 18-6pt. Flank socket | 4; 4.5; 5; 5.5; 6; 7; 8; 9; 10; 11; 12; 13 mm | |
| 525 3.16...1.2 | 3/16"; 1/4"; 9/32"; 11/32"; 3/8"; 1/2" | | |
| 18-6pt. Flank deep socket | | | |
| 52550 04...13 | 4; 4.5; 5; 5.5; 6; 7; 8; 9; 10; 11; 12; 13 mm | | |
| 52550 3.16...1.2 | 3/16"; 1/4"; 9/32"; 11/32"; 3/8"; 1/2" | | |
| 30-Socket bit (32mmL) | | | |
| 32432 03...10 | Hex 3, 4, 5, 6, 7, 8, 10 mm | | |
| 32432 1.8...3.8 | Hex 1/8"; 3/16"; 7/32"; 1/4"; 3/8" | | |
| 32132 1...3 | Phillips PH.1, PH.2, PH.3 | | |
| 32232 1...3 | Pozidriv PZ.1, PZ.2, PZ.3 | | |
| 32332 03...065 | Slotted 3; 4, 5.5, 6.5 mm | | |
| 32632 08...40 | Star T8; T10; T15; T20; T25; T27; T30; T40 | | |
| 802215 | 1-Ratchet handle | | |
| 8042 050...150 | 3-Extension bar 2"; 4"; 6" | | |
| 8032115 | 1-Sliding T handle | | |
| 80521 | 1-Universal joint | | |
| 8143 | 1-Spinner 6" | | |
| 81225 | 1-Magnetic socket pick-up | | |

74pc 1/4" Socket combination set

| Part no. | Socket | 6/12.7/13.7/0.9' | 1580g |
|-----------------------|--|---|-------|
| 2742 | | | |
| Content: 1/4" DR. | | | |
| 525 04...13 | 12-6pt. Flank socket | 4; 4.5; 5; 5.5; 6; 7; 8; 9; 10; 11; 12; 13 mm | |
| 52550 04...13 | 12-6pt. Flank deep socket | 4; 4.5; 5; 5.5; 6; 7; 8; 9; 10; 11; 12; 13 mm | |
| 526 04...10 | 6-Star socket | E4; E5; E6; E7; E8; E10 | |
| 52650 04...10 | 6-Star deep socket | E4; E5; E6; E7; E8; E10 | |
| 32-Socket bit (32mmL) | | | |
| 32432 03...10 | Hex 3; 4; 5; 6; 7; 8; 10 mm | | |
| 32132 0...2 | Phillips PH.0; PH.1; PH.2 | | |
| 32232 0...2 | Pozidriv PZ.0; PZ.1; PZ.2 | | |
| 32332 04...065 | Slotted 4; 5.5; 6.5 mm | | |
| 32632 08...40 | Star T8; T10; T15; T20; T25; T27; T30; T40 | | |
| 32732 08...40 | Star tamperproof T-8H; T-10H; T-15H; T-20H; T-25H; T-27H; T-30H; T-40H | | |
| 802220 | 1-T mini ratchet | | |
| 8042 050...150 | 3-Extension bar 2"; 4"; 6" | | |
| 80521 | 1-Universal joint | | |
| 81225 | 1-Magnetic socket pick-up | | |

74pc Socket combination set

| Part no. | Socket | 6/12.7/13.7/0.9' | 1580g |
|-----------------------|--|---|-------|
| 2742-18 | | | |
| Content: 1/4" DR. | | | |
| 525 04...13 | 12-6pt. Flank socket | 4; 4.5; 5; 5.5; 6; 7; 8; 9; 10; 11; 12; 13 mm | |
| 52550 04...13 | 12-6pt. Flank deep socket | 4; 4.5; 5; 5.5; 6; 7; 8; 9; 10; 11; 12; 13 mm | |
| 526 04...10 | 6-Star socket | E4; E5; E6; E7; E8; E10 | |
| 52650 04...10 | 6-Star deep socket | E4; E5; E6; E7; E8; E10 | |
| 32-Socket bit (32mmL) | | | |
| 32432 03...10 | Hex 3; 4; 5; 6; 7; 8; 10 mm | | |
| 32132 0...2 | Phillips PH.0; PH.1; PH.2 | | |
| 32232 0...2 | Pozidriv PZ.0; PZ.1; PZ.2 | | |
| 32332 04...065 | Slotted 4; 5.5; 6.5 mm | | |
| 32632 08...40 | Star T8; T10; T15; T20; T25; T27; T30; T40 | | |
| 32732 08...40 | Star tamperproof T-8H; T-10H; T-15H; T-20H; T-25H; T-27H; T-30H; T-40H | | |
| 802218 | 1-Flexible ratchet | | |
| 8042 050...150 | 3-Extension bar 2"; 4"; 6" | | |
| 80521 | 1-Universal joint | | |
| 81225 | 1-Magnetic socket pick-up | | |



102pc 1/4" bit set

| Part no. | 10/9.7/10.7/1' | 970g |
|----------------|---|------|
| 21021 | | |
| 12125 0...3 | Content: 40-1/4" Phillips bit (25mmL) PH.0; PH.1; PH.2; PH.3 each 10pcs | |
| 12225 1...3 | 30-1/4" Pozidriv bit (25mmL) PZ.1; PZ.2; PZ.3 each 10pcs | |
| 12325 04...065 | 30-1/4" Slotted bit (25mmL) 4; 5.5; 6.5 mm each 10pcs | |
| 81260 | 1-Magnetic bit holder (60mmL) | |
| 81260Q | 1-Magnetic quick-release bit holder | |



102pc 1/4" bit set

| Part no. | 20/17.8/18.8/0.9' | 1550g |
|----------------|--|-------|
| 21022 | | |
| 12125 1...3 | Content: 15-Phillips bits (25mmL) PH.1x5pc; PH.2x5pc; PH.3x5pc | |
| 12225 1...3 | 15-Pozidriv bits (25mmL) PZ.1x5pc; PZ.2x5pc; PZ.3x5pc | |
| 12325 04...065 | 15-Slotted bits (25mmL) 4x5pc; 5.5x5pc; 6.5x5pc | |
| 12425 02...06 | 10-Hex bits (25mmL) 2x2pc; 3x2pc; 4x2pc; 5x2pc; 6x2pc | |
| 12625 06...40 | 27-Star bits (25mmL) T6x3pc; T8x3pc; T10x3pc; T15x3pc; T20x3pc; T25x3pc; T27x3pc; T30x3pc; T40x3pc | |
| 12725 06...40 | 18-Star tamperproof bits (25mmL) T-6Hx2pc; T-8Hx2pc; T-10Hx2pc; T-15Hx2pc; T-20Hx2pc; T-25Hx2pc; T-27Hx2pc; T-30Hx2pc; T-40Hx2pc | |
| 81260Q | 1-Magnetic quick-release bit holder | |
| 81260 | 1-Magnetic bit holder (60mmL) | |



1/4" Phillips bit

| Part no. | size | mm | g | pc/box |
|-------------------|------|----------|----|--------|
| 121 | | <i>l</i> | | |
| 121250 | PH.0 | 25 | 4 | 10 |
| 121251 | PH.1 | 25 | 4 | 10 |
| 121252 | PH.2 | 25 | 6 | 10 |
| 121253 | PH.3 | 25 | 6 | 10 |
| 121300 | PH.0 | 30 | 6 | 10 |
| 121301 | PH.1 | 30 | 6 | 10 |
| 121302 | PH.2 | 30 | 6 | 10 |
| 121303 | PH.3 | 30 | 6 | 10 |
| 121304 NEW | PH.4 | 30 | 6 | 10 |
| 121501 NEW | PH.1 | 50 | 12 | 10 |
| 121502 NEW | PH.2 | 50 | 12 | 10 |
| 121503 NEW | PH.3 | 50 | 13 | 10 |

NEW



1/4" Double-sized Phillips bit

| Part no. | size | mm | g | pc/bag |
|-------------|-----------|----------|----|--------|
| 121D | | <i>l</i> | | |
| 121D12 | PH.1xPH.2 | 165 | 40 | 10 |
| 121D34 | PH.3xPH.4 | 165 | 42 | 10 |



1/4" Pozidriv bit

| Part no. | size | mm | g | pc/box |
|-------------------|------|----------|----|--------|
| 122 | | <i>l</i> | | |
| 122250 | PZ.0 | 25 | 4 | 10 |
| 122251 | PZ.1 | 25 | 4 | 10 |
| 122252 | PZ.2 | 25 | 6 | 10 |
| 122253 | PZ.3 | 25 | 6 | 10 |
| 122300 | PZ.0 | 30 | 6 | 10 |
| 122301 | PZ.1 | 30 | 6 | 10 |
| 122302 | PZ.2 | 30 | 6 | 10 |
| 122303 | PZ.3 | 30 | 6 | 10 |
| 122304 NEW | PZ.4 | 30 | 6 | 10 |
| 122501 NEW | PZ.1 | 50 | 12 | 10 |
| 122502 NEW | PZ.2 | 50 | 12 | 10 |
| 122503 NEW | PZ.3 | 50 | 13 | 10 |

NEW



1/4" Double-sized Pozidriv bit

| Part no. | size | mm | g | pc/bag |
|-------------|-----------|----------|----|--------|
| 122D | | <i>l</i> | | |
| 122D12 | PZ.1xPZ.2 | 165 | 41 | 10 |
| 122D34 | PZ.3xPZ.4 | 165 | 42 | 10 |



1/4" Slotted bit

| Part no. | size | mm | g | pc/box |
|--------------------|---------|----------|---|--------|
| 123 | | <i>l</i> | | |
| 1232503 | 0.5x3 | 25 | 4 | 10 |
| 1232504 | 0.8x4 | 25 | 4 | 10 |
| 1232505 | 0.8x5 | 25 | 4 | 10 |
| 12325055 | 1.0x5.5 | 25 | 4 | 10 |
| 12325065 | 1.2x6.5 | 25 | 4 | 10 |
| 1233004 | 0.8x4 | 30 | 6 | 10 |
| 1233005 | 0.8x5 | 30 | 6 | 10 |
| 12330055 | 1.0x5.5 | 30 | 6 | 10 |
| 1233006 | 1.0x6 | 30 | 6 | 10 |
| 12330065 | 1.2x6.5 | 30 | 6 | 10 |
| 1233007 | 1.2x7 | 30 | 6 | 10 |
| 1235003 NEW | 0.5X3 | 50 | 8 | 10 |
| 1235004 NEW | 0.8X4 | 50 | 8 | 10 |
| 1235005 NEW | 0.8X5 | 50 | 8 | 10 |
| 1235006 NEW | 1.0X6 | 50 | 9 | 10 |
| 1235007 NEW | 1.2X7 | 50 | 9 | 10 |

NEW



1/4" Double-sized slotted bit

| Part no. | size | mm | g | pc/bag |
|-------------|-----------|----------|----|--------|
| 123D | | <i>l</i> | | |
| 123D0304 | 3mmx4mm | 165 | 39 | 10 |
| 123D05507 | 5.5mmx7mm | 165 | 41 | 10 |

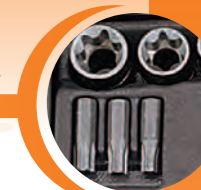

1/4" Hex bit

| 124 | | | | |
|------------|-------|----|----|--------|
| Part no. | size | mm | g | pc/box |
| 12425015 | 1.5 | 25 | 4 | 10 |
| 1242502 | 2 | 25 | 4 | 10 |
| 12425025 | 2.5 | 25 | 4 | 10 |
| 1242503 | 3 | 25 | 4 | 10 |
| 1242504 | 4 | 25 | 5 | 10 |
| 1242505 | 5 | 25 | 5 | 10 |
| 12425055 | 5.5 | 25 | 5 | 10 |
| 1242506 | 6 | 25 | 5 | 10 |
| 1242507 | 7 | 25 | 6 | 10 |
| 1242508 | 8 | 25 | 6 | 10 |
| 1242510 | 10 | 25 | 8 | 10 |
| 124251.16 | 1/16" | 25 | 4 | 10 |
| 124253.32 | 3/32" | 25 | 4 | 10 |
| 124251.8 | 1/8" | 25 | 4 | 10 |
| 124255.32 | 5/32" | 25 | 5 | 10 |
| 124253.16 | 3/16" | 25 | 4 | 10 |
| 124257.32 | 7/32" | 25 | 4 | 10 |
| 124251.4 | 1/4" | 25 | 4 | 10 |
| 124259.32 | 9/32" | 25 | 4 | 10 |
| 124255.16 | 5/16" | 25 | 6 | 10 |
| 124253.8 | 3/8" | 25 | 6 | 10 |
| 12430015 | 1.5 | 30 | 6 | 10 |
| 1243002 | 2 | 30 | 6 | 10 |
| 12430025 | 2.5 | 30 | 6 | 10 |
| 1243003 | 3 | 30 | 6 | 10 |
| 1243004 | 4 | 30 | 7 | 10 |
| 1243005 | 5 | 30 | 8 | 10 |
| 12430055 | 5.5 | 30 | 8 | 10 |
| 1243006 | 6 | 30 | 8 | 10 |
| 1243007 | 7 | 30 | 8 | 10 |
| 1243008 | 8 | 30 | 10 | 10 |
| 1243010 | 10 | 30 | 12 | 10 |
| 124301.8 | 1/8" | 30 | 6 | 10 |
| 124305.32 | 5/32" | 30 | 7 | 10 |
| 124303.16 | 3/16" | 30 | 7 | 10 |
| 124307.32 | 7/32" | 30 | 8 | 10 |
| 124301.4 | 1/4" | 30 | 8 | 10 |
| 124305.16 | 5/16" | 30 | 8 | 10 |
| 124303.8 | 3/8" | 30 | 12 | 10 |

NEW



1/4" Double-sized hex bit

| 124D | | | | |
|-------------|---------|-----|----|--------|
| Part no. | size | mm | g | pc/bag |
| 124D0304 | 3mmx4mm | 165 | 40 | 10 |
| 124D0506 | 5mmx6mm | 165 | 43 | 10 |



1/4" Hex ball point bit

| 125 | | | | |
|------------|-------|----|---|--------|
| Part no. | size | mm | g | pc/box |
| 12525025 | 2.5 | 25 | 4 | 10 |
| 1252503 | 3 | 25 | 4 | 10 |
| 1252504 | 4 | 25 | 4 | 10 |
| 1252505 | 5 | 25 | 6 | 10 |
| 12525055 | 5.5 | 25 | 6 | 10 |
| 1252506 | 6 | 25 | 6 | 10 |
| 125251.8 | 1/8" | 25 | 4 | 10 |
| 125255.32 | 5/32" | 25 | 4 | 10 |
| 125253.16 | 3/16" | 25 | 4 | 10 |
| 125257.32 | 7/32" | 25 | 6 | 10 |
| 125251.4 | 1/4" | 25 | 6 | 10 |
| 12530025 | 2.5 | 30 | 6 | 10 |
| 1253003 | 3 | 30 | 6 | 10 |
| 1253004 | 4 | 30 | 6 | 10 |
| 1253005 | 5 | 30 | 8 | 10 |
| 12530055 | 5.5 | 30 | 8 | 10 |
| 1253006 | 6 | 30 | 8 | 10 |
| 125301.8 | 1/8" | 30 | 6 | 10 |
| 125305.32 | 5/32" | 30 | 6 | 10 |
| 125303.16 | 3/16" | 30 | 6 | 10 |
| 125307.32 | 7/32" | 30 | 8 | 10 |
| 125301.4 | 1/4" | 30 | 8 | 10 |



1/4" Star bit

| 126 | | | | |
|------------|------|----|----|--------|
| Part no. | size | mm | g | pc/box |
| 1262504 | T4 | 25 | 4 | 10 |
| 1262505 | T5 | 25 | 4 | 10 |
| 1262506 | T6 | 25 | 4 | 10 |
| 1262507 | T7 | 25 | 4 | 10 |
| 1262508 | T8 | 25 | 4 | 10 |
| 1262509 | T9 | 25 | 4 | 10 |
| 1262510 | T10 | 25 | 4 | 10 |
| 1262515 | T15 | 25 | 4 | 10 |
| 1262520 | T20 | 25 | 4 | 10 |
| 1262525 | T25 | 25 | 4 | 10 |
| 1262527 | T27 | 25 | 6 | 10 |
| 1262530 | T30 | 25 | 6 | 10 |
| 1262535 | T35 | 25 | 6 | 10 |
| 1262540 | T40 | 25 | 6 | 10 |
| 1263004 | T4 | 30 | 6 | 10 |
| 1263005 | T5 | 30 | 6 | 10 |
| 1263006 | T6 | 30 | 6 | 10 |
| 1263007 | T7 | 30 | 6 | 10 |
| 1263008 | T8 | 30 | 6 | 10 |
| 1263009 | T9 | 30 | 6 | 10 |
| 1263010 | T10 | 30 | 6 | 10 |
| 1263015 | T15 | 30 | 6 | 10 |
| 1263020 | T20 | 30 | 6 | 10 |
| 1263025 | T25 | 30 | 6 | 10 |
| 1263027 | T27 | 30 | 8 | 10 |
| 1263030 | T30 | 30 | 8 | 10 |
| 1263040 | T40 | 30 | 8 | 10 |
| 1263045 | T45 | 30 | 10 | 10 |
| 1263050 | T50 | 30 | 10 | 10 |
| 1263055 | T55 | 30 | 12 | 10 |
| 1266525 | T25 | 65 | 16 | 10 |



1/4" Star tamperproof bit

| 127 | | | | |
|------------|-------|----|---|--------|
| Part no. | size | mm | g | pc/box |
| 1272506 | T-6H | 25 | 4 | 10 |
| 1272507 | T-7H | 25 | 4 | 10 |
| 1272508 | T-8H | 25 | 4 | 10 |
| 1272509 | T-9H | 25 | 4 | 10 |
| 1272510 | T-10H | 25 | 4 | 10 |
| 1272515 | T-15H | 25 | 4 | 10 |
| 1272520 | T-20H | 25 | 4 | 10 |
| 1272525 | T-25H | 25 | 4 | 10 |
| 1272527 | T-27H | 25 | 6 | 10 |
| 1272530 | T-30H | 25 | 6 | 10 |
| 1272535 | T-35H | 25 | 6 | 10 |
| 1272540 | T-40H | 25 | 6 | 10 |
| 1273006 | T-6H | 30 | 6 | 10 |
| 1273007 | T-7H | 30 | 6 | 10 |
| 1273008 | T-8H | 30 | 6 | 10 |
| 1273009 | T-9H | 30 | 6 | 10 |
| 1273010 | T-10H | 30 | 6 | 10 |
| 1273015 | T-15H | 30 | 6 | 10 |
| 1273020 | T-20H | 30 | 6 | 10 |
| 1273025 | T-25H | 30 | 6 | 10 |
| 1273027 | T-27H | 30 | 8 | 10 |
| 1273030 | T-30H | 30 | 8 | 10 |
| 1273040 | T-40H | 30 | 8 | 10 |

NEW



1/4" Double-sized star bit

| 126D | | | | |
|-------------|---------|-----|----|--------|
| Part no. | size | mm | g | pc/bag |
| 126D0810 | T8xT10 | 165 | 39 | 10 |
| 126D1520 | T15xT20 | 165 | 40 | 10 |
| 126D2527 | T25xT27 | 165 | 41 | 10 |
| 126D3040 | T30xT40 | 165 | 42 | 10 |



1/4" Spline bit

| 128 | | | | |
|------------|------|----|---|--------|
| Part no. | size | mm | g | pc/box |
| 1282504 | M4 | 25 | 4 | 10 |
| 1282505 | M5 | 25 | 4 | 10 |
| 1282506 | M6 | 25 | 6 | 10 |
| 1282508 | M8 | 25 | 6 | 10 |
| 1282510 | M10 | 25 | 8 | 10 |



1/4" Five-sided star tamperproof bit

| 12F | | <i>l</i> | | |
|----------|------|----------|---|--------|
| Part no. | size | mm | g | pc/box |
| 12F2508 | TS8 | 25 | 4 | 10 |
| 12F2510 | TS10 | 25 | 4 | 10 |
| 12F2515 | TS15 | 25 | 4 | 10 |
| 12F2520 | TS20 | 25 | 4 | 10 |
| 12F2525 | TS25 | 25 | 4 | 10 |
| 12F2527 | TS27 | 25 | 4 | 10 |
| 12F2530 | TS30 | 25 | 4 | 10 |
| 12F2540 | TS40 | 25 | 4 | 10 |
| 12F2545 | TS45 | 25 | 6 | 10 |
| 12F2550 | TS50 | 25 | 8 | 10 |



1/4" Spanner bit

| 123S | | <i>l</i> | | |
|----------|------|----------|---|--------|
| Part no. | size | mm | g | pc/box |
| 123S2504 | 4 | 25 | 6 | 10 |
| 123S2506 | 6 | 25 | 6 | 10 |
| 123S2508 | 8 | 25 | 6 | 10 |
| 123S2510 | 10 | 25 | 6 | 10 |



1/4" Hex security bit

| 124S | | <i>l</i> | | |
|------------|-------|----------|---|--------|
| Part no. | size | mm | g | pc/box |
| 124S2502 | 2 | 25 | 6 | 10 |
| 124S25025 | 2.5 | 25 | 6 | 10 |
| 124S2503 | 3 | 25 | 6 | 10 |
| 124S2504 | 4 | 25 | 6 | 10 |
| 124S2505 | 5 | 25 | 6 | 10 |
| 124S2506 | 6 | 25 | 6 | 10 |
| 124S255.64 | 5/64" | 25 | 6 | 10 |
| 124S253.32 | 3/32" | 25 | 6 | 10 |
| 124S257.64 | 7/64" | 25 | 6 | 10 |
| 124S251.8 | 1/8" | 25 | 6 | 10 |
| 124S259.64 | 9/64" | 25 | 6 | 10 |
| 124S255.32 | 5/32" | 25 | 6 | 10 |



1/4" Torq set bit

| 121S | | <i>l</i> | | |
|-----------|------|----------|---|--------|
| Part no. | size | mm | g | pc/box |
| 121S2506 | 6 | 25 | 6 | 10 |
| 121S2508 | 8 | 25 | 6 | 10 |
| 121S2510 | 10 | 25 | 6 | 10 |
| 121S251.4 | 1/4" | 25 | 6 | 10 |



1/4" Tri-wing bit

| 122S | | <i>l</i> | | |
|----------|------|----------|---|--------|
| Part no. | size | mm | g | pc/box |
| 122S2501 | 1 | 25 | 6 | 10 |
| 122S2502 | 2 | 25 | 6 | 10 |
| 122S2503 | 3 | 25 | 6 | 10 |
| 122S2504 | 4 | 25 | 6 | 10 |



1/4" Square bit

| 124R | | <i>l</i> | | |
|------------------------|------|----------|----|--------|
| Part no. | size | mm | g | pc/box |
| 124R250 | 0 | 25 | 6 | 10 |
| 124R251 | 1 | 25 | 6 | 10 |
| 124R252 | 2 | 25 | 6 | 10 |
| 124R253 | 3 | 25 | 6 | 10 |
| 124R500 ^{NEW} | 0 | 50 | 12 | 10 |
| 124R501 ^{NEW} | 1 | 50 | 12 | 10 |
| 124R502 ^{NEW} | 2 | 50 | 12 | 10 |



1/4" Phillips socket bit

| 321 | | <i>l</i> | | |
|-----------------------|------|----------|----|--------|
| Part no. | size | mm | g | pc/box |
| 321320 | PH.0 | 32 | 12 | 50 |
| 321321 | PH.1 | 32 | 12 | 50 |
| 321322 | PH.2 | 32 | 12 | 50 |
| 321323 | PH.3 | 32 | 14 | 50 |
| 321324 ^{NEW} | PH.4 | 32 | 14 | 50 |



1/4" Hex socket bit

| 324 | | <i>l</i> | | |
|------------------------|-------|----------|----|--------|
| Part no. | size | mm | g | pc/box |
| 3243203 | 3 | 32 | 13 | 50 |
| 3243204 | 4 | 32 | 14 | 50 |
| 3243205 | 5 | 32 | 14 | 50 |
| 3243206 | 6 | 32 | 14 | 50 |
| 3243207 | 7 | 32 | 16 | 50 |
| 3243208 | 8 | 32 | 17 | 50 |
| 3243209 ^{NEW} | 9 | 32 | 20 | 50 |
| 3243210 | 10 | 32 | 21 | 50 |
| 324321.8 | 1/8" | 32 | 14 | 50 |
| 324325.32 | 5/32" | 32 | 14 | 50 |
| 324323.16 | 3/16" | 32 | 14 | 50 |
| 324327.32 | 7/32" | 32 | 14 | 50 |
| 324321.4 | 1/4" | 32 | 16 | 50 |
| 324325.16 | 5/16" | 32 | 16 | 50 |
| 324323.8 | 3/8" | 32 | 20 | 50 |



1/4" Pozidriv socket bit

| 322 | | <i>l</i> | | |
|-----------------------|------|----------|----|--------|
| Part no. | size | mm | g | pc/box |
| 322320 | PZ.0 | 32 | 12 | 50 |
| 322321 | PZ.1 | 32 | 12 | 50 |
| 322322 | PZ.2 | 32 | 12 | 50 |
| 322323 | PZ.3 | 32 | 14 | 50 |
| 322324 ^{NEW} | PZ.4 | 32 | 14 | 50 |



1/4" Star socket bit

| 326 | | <i>l</i> | | |
|------------------------|------|----------|----|--------|
| Part no. | size | mm | g | pc/box |
| 3263208 | T8 | 32 | 13 | 50 |
| 3263209 | T9 | 32 | 13 | 50 |
| 3263210 | T10 | 32 | 13 | 50 |
| 3263215 | T15 | 32 | 13 | 50 |
| 3263220 | T20 | 32 | 14 | 50 |
| 3263225 | T25 | 32 | 14 | 50 |
| 3263227 | T27 | 32 | 14 | 50 |
| 3263230 | T30 | 32 | 14 | 50 |
| 3263235 ^{NEW} | T35 | 32 | 14 | 50 |
| 3263240 | T40 | 32 | 15 | 50 |
| 3269030 | T30 | 90 | 26 | 10 |



1/4" Slotted socket bit

| 323 | | <i>l</i> | | |
|------------------------|---------|----------|----|--------|
| Part no. | size | mm | g | pc/box |
| 3233203 ^{NEW} | 0.5x3 | 32 | 12 | 50 |
| 3233204 | 0.8x4 | 32 | 12 | 50 |
| 32332055 | 1.0x5.5 | 32 | 12 | 50 |
| 3233206 ^{NEW} | 1.0x6 | 32 | 12 | 50 |
| 32332065 | 1.2x6.5 | 32 | 12 | 50 |
| 3233207 | 1.2x7 | 32 | 12 | 50 |
| 323325.32 | 5/32" | 32 | 12 | 50 |
| 323327.32 | 7/32" | 32 | 12 | 50 |
| 323321.4 | 1/4" | 32 | 12 | 50 |

*3269030 -T30 90mmL

*To remove and replace the screws on airbag of VW-Audi.



1/4" Star tamperproof socket bit

| 327 | | <i>l</i> | | |
|----------------------------|-------|----------|----|--------|
| Part no. | size | mm | g | pc/box |
| 3273208 | T-8H | 32 | 13 | 50 |
| 3273210 | T-10H | 32 | 13 | 50 |
| 3273215 | T-15H | 32 | 13 | 50 |
| 3273220 | T-20H | 32 | 14 | 50 |
| 3273225 | T-25H | 32 | 14 | 50 |
| 3273227 | T-27H | 32 | 14 | 50 |
| 3273230 | T-30H | 32 | 14 | 50 |
| 3273235 <small>NEW</small> | T-35H | 32 | 14 | 50 |
| 3273240 | T-40H | 32 | 14 | 50 |



1/4" Five-sided star tamperproof socket bit

| 32F | | <i>l</i> | | |
|------------|------|----------|----|--------|
| Part no. | size | mm | g | pc/box |
| 32F3210 | TS10 | 32 | 12 | 50 |
| 32F3215 | TS15 | 32 | 12 | 50 |
| 32F3220 | TS20 | 32 | 12 | 50 |
| 32F3225 | TS25 | 32 | 12 | 50 |
| 32F3227 | TS27 | 32 | 14 | 50 |
| 32F3230 | TS30 | 32 | 14 | 50 |
| 32F3240 | TS40 | 32 | 14 | 50 |



1/4" DR. 6pt. Flank socket

| 525 | | <i>l</i> | | |
|-----------------------------|--------|----------|----|--------|
| Part no. | size | mm | g | pc/box |
| 525032 | 3.2 | 25 | 10 | 50 |
| 52504 | 4 | 25 | 10 | 50 |
| 525045 | 4.5 | 25 | 11 | 50 |
| 52505 | 5 | 25 | 11 | 50 |
| 525055 | 5.5 | 25 | 11 | 50 |
| 52506 | 6 | 25 | 11 | 50 |
| 52507 | 7 | 25 | 12 | 50 |
| 52508 | 8 | 25 | 12 | 50 |
| 52509 | 9 | 25 | 14 | 50 |
| 52510 | 10 | 25 | 15 | 50 |
| 52511 | 11 | 25 | 18 | 50 |
| 52512 | 12 | 25 | 21 | 50 |
| 52513 | 13 | 25 | 22 | 50 |
| 52514 | 14 | 25 | 36 | 50 |
| 5255.32 | 5/32" | 25 | 11 | 50 |
| 5253.16 | 3/16" | 25 | 11 | 50 |
| 5257.32 | 7/32" | 25 | 11 | 50 |
| 5251.4 | 1/4" | 25 | 11 | 50 |
| 5259.32 | 9/32" | 25 | 12 | 50 |
| 5255.16 | 5/16" | 25 | 12 | 50 |
| 52511.32 | 11/32" | 25 | 14 | 50 |
| 5253.8 | 3/8" | 25 | 14 | 50 |
| 52513.32 <small>NEW</small> | 13/32" | 25 | 16 | 50 |
| 5257.16 | 7/16" | 25 | 18 | 50 |
| 52515.32 <small>NEW</small> | 15/32" | 25 | 20 | 50 |
| 5251.2 | 1/2" | 25 | 21 | 50 |
| 5259.16 | 9/16" | 25 | 22 | 50 |



1/4" DR. 6pt. Flank deep socket

| 52550 | | <i>l</i> | | |
|------------------------------|--------|----------|----|--------|
| Part no. | size | mm | g | pc/box |
| 5255004 | 4 | 50 | 14 | 50 |
| 52550045 | 4.5 | 50 | 16 | 50 |
| 5255005 | 5 | 50 | 17 | 50 |
| 52550055 | 5.5 | 50 | 18 | 50 |
| 5255006 | 6 | 50 | 20 | 50 |
| 5255007 | 7 | 50 | 22 | 50 |
| 5255008 | 8 | 50 | 27 | 50 |
| 5255009 | 9 | 50 | 29 | 40 |
| 5255010 | 10 | 50 | 34 | 30 |
| 5255011 | 11 | 50 | 40 | 30 |
| 5255012 | 12 | 50 | 41 | 20 |
| 5255013 | 13 | 50 | 52 | 20 |
| 5255014 | 14 | 50 | 54 | 20 |
| 525505.32 | 5/32" | 50 | 14 | 50 |
| 525503.16 | 3/16" | 50 | 17 | 50 |
| 525507.32 | 7/32" | 50 | 18 | 50 |
| 525501.4 | 1/4" | 50 | 20 | 50 |
| 525509.32 | 9/32" | 50 | 22 | 50 |
| 525505.16 | 5/16" | 50 | 27 | 50 |
| 5255011.32 | 11/32" | 50 | 29 | 40 |
| 525503.8 | 3/8" | 50 | 34 | 30 |
| 525507.16 | 7/16" | 50 | 40 | 30 |
| 525501.2 | 1/2" | 50 | 52 | 20 |
| 525509.16 <small>NEW</small> | 9/16" | 50 | 54 | 20 |



1/4" DR. Star socket

| 526 | | <i>l</i> | | |
|------------|------|----------|----|--------|
| Part no. | size | mm | g | pc/box |
| 52604 | E4 | 25 | 10 | 50 |
| 52605 | E5 | 25 | 10 | 50 |
| 52606 | E6 | 25 | 11 | 50 |
| 52607 | E7 | 25 | 11 | 50 |
| 52608 | E8 | 25 | 12 | 50 |
| 52610 | E10 | 25 | 12 | 50 |
| 52611 | E11 | 25 | 14 | 50 |
| 52612 | E12 | 25 | 17 | 50 |
| 52614 | E14 | 25 | 21 | 50 |
| 52616 | E16 | 25 | 30 | 50 |



1/4" DR. Star deep socket

| 52650 | | <i>l</i> | | |
|----------------------------|------|----------|----|--------|
| Part no. | size | mm | g | pc/box |
| 5265004 | E4 | 50 | 14 | 50 |
| 5265005 | E5 | 50 | 19 | 50 |
| 5265006 | E6 | 50 | 19 | 50 |
| 5265007 | E7 | 50 | 21 | 50 |
| 5265008 | E8 | 50 | 23 | 50 |
| 5265010 | E10 | 50 | 28 | 30 |
| 5265012 <small>NEW</small> | E12 | 50 | 32 | 20 |
| 5265014 <small>NEW</small> | E14 | 50 | 43 | 20 |
| 5265016 <small>NEW</small> | E16 | 50 | 53 | 20 |



1/4" DR. Surface drive socket

| 527 | | <i>l</i> | | |
|------------|--------|----------|----|--------|
| Part no. | size | mm | g | pc/box |
| 52704 | 4 | 25 | 10 | 50 |
| 527045 | 4.5 | 25 | 10 | 50 |
| 52705 | 5 | 25 | 10 | 50 |
| 527055 | 5.5 | 25 | 11 | 50 |
| 52706 | 6 | 25 | 11 | 50 |
| 52707 | 7 | 25 | 12 | 50 |
| 52708 | 8 | 25 | 12 | 50 |
| 52709 | 9 | 25 | 13 | 50 |
| 52710 | 10 | 25 | 15 | 50 |
| 52711 | 11 | 25 | 24 | 50 |
| 52712 | 12 | 25 | 28 | 50 |
| 52713 | 13 | 25 | 32 | 50 |
| 52714 | 14 | 25 | 36 | 50 |
| 5273.16 | 3/16" | 25 | 11 | 50 |
| 5277.32 | 7/32" | 25 | 11 | 50 |
| 5271.4 | 1/4" | 25 | 12 | 50 |
| 5279.32 | 9/32" | 25 | 12 | 50 |
| 5275.16 | 5/16" | 25 | 12 | 50 |
| 52711.32 | 11/32" | 25 | 13 | 50 |
| 5273.8 | 3/8" | 25 | 15 | 50 |
| 5277.16 | 7/16" | 25 | 24 | 50 |
| 5271.2 | 1/2" | 25 | 32 | 50 |
| 5279.16 | 9/16" | 25 | 38 | 50 |

1/4" DR. Surface drive deep socket

| 52750 | | <i>l</i> | | |
|---------------------|------|----------|----|--------|
| Part no. | size | mm | g | pc/box |
| 5275004 NEW | 4 | 50 | 17 | 50 |
| 52750045 NEW | 4.5 | 50 | 17 | 50 |
| 4275005 NEW | 5 | 50 | 17 | 50 |
| 52750055 NEW | 5.5 | 50 | 17 | 50 |
| 5275006 | 6 | 50 | 20 | 50 |
| 5275007 | 7 | 50 | 20 | 50 |
| 5275008 | 8 | 50 | 24 | 50 |
| 5275009 | 9 | 50 | 30 | 40 |
| 5275010 | 10 | 50 | 36 | 30 |
| 5275011 | 11 | 50 | 46 | 30 |
| 5275012 | 12 | 50 | 50 | 20 |
| 5275013 | 13 | 50 | 52 | 20 |
| 5275014 NEW | 14 | 50 | 53 | 20 |

1/4" DR. 12pt. Flank socket

| 529 | | <i>l</i> | | |
|---------------------|--------|----------|----|--------|
| Part no. | size | mm | g | pc/box |
| 529032 NEW | 3.2 | 25 | 10 | 50 |
| 52904 | 4 | 25 | 10 | 50 |
| 529045 | 4.5 | 25 | 11 | 50 |
| 52905 | 5 | 25 | 11 | 50 |
| 529055 | 5.5 | 25 | 11 | 50 |
| 52906 | 6 | 25 | 11 | 50 |
| 52907 | 7 | 25 | 12 | 50 |
| 52908 | 8 | 25 | 12 | 50 |
| 52909 | 9 | 25 | 13 | 50 |
| 52910 | 10 | 25 | 15 | 50 |
| 52911 | 11 | 25 | 19 | 50 |
| 52912 | 12 | 25 | 20 | 50 |
| 52913 | 13 | 25 | 22 | 50 |
| 52914 | 14 | 25 | 25 | 50 |
| 5295.32 | 5/32" | 25 | 11 | 50 |
| 5293.16 | 3/16" | 25 | 11 | 50 |
| 5297.32 | 7/32" | 25 | 11 | 50 |
| 5291.4 | 1/4" | 25 | 12 | 50 |
| 5299.32 | 9/32" | 25 | 12 | 50 |
| 5295.16 | 5/16" | 25 | 12 | 50 |
| 52911.32 | 11/32" | 25 | 13 | 50 |
| 5293.8 | 3/8" | 25 | 15 | 50 |
| 52913.32 NEW | 13/32" | 25 | 15 | 50 |
| 5297.16 | 7/16" | 25 | 19 | 50 |
| 52915.32 NEW | 15/32" | 25 | 20 | 50 |
| 5291.2 | 1/2" | 25 | 22 | 50 |
| 5299.16 | 9/16" | 25 | 25 | 50 |

1/4" DR. 12pt. Flank deep socket

| 52950 | | <i>l</i> | | |
|-----------------------|--------|----------|----|--------|
| Part no. | size | mm | g | pc/box |
| 5295004 NEW | 4 | 50 | 16 | 50 |
| 52950045 NEW | 4.5 | 50 | 16 | 50 |
| 5295005 | 5 | 50 | 18 | 50 |
| 52950055 | 5.5 | 50 | 18 | 50 |
| 5295006 | 6 | 50 | 21 | 50 |
| 5295007 | 7 | 50 | 22 | 50 |
| 5295008 | 8 | 50 | 22 | 50 |
| 5295009 | 9 | 50 | 28 | 40 |
| 5295010 | 10 | 50 | 33 | 30 |
| 5295011 | 11 | 50 | 44 | 30 |
| 5295012 | 12 | 50 | 44 | 20 |
| 5295013 | 13 | 50 | 45 | 20 |
| 5295014 NEW | 14 | 50 | 49 | 20 |
| 529505.32 NEW | 5/32" | 50 | 14 | 50 |
| 529503.16 NEW | 3/16" | 50 | 17 | 50 |
| 529507.32 NEW | 7/32" | 50 | 18 | 50 |
| 529501.4 NEW | 1/4" | 50 | 20 | 50 |
| 529509.32 NEW | 9/32" | 50 | 22 | 50 |
| 529505.16 NEW | 5/16" | 50 | 27 | 50 |
| 5295011.32 NEW | 11/32" | 50 | 29 | 40 |
| 529503.8 NEW | 3/8" | 50 | 34 | 30 |
| 529507.16 NEW | 7/16" | 50 | 40 | 30 |
| 529501.2 NEW | 1/2" | 50 | 52 | 20 |
| 529509.16 NEW | 9/16" | 50 | 52 | 20 |



1/4" DR. Spline socket

| 52Q | | | | | | | | | |
|------------|------|--------|---------|--------|--------|-----|---------|----|--------|
| Part no. | size | 6point | 12point | SAE | E-Torx | XZN | l mm | g | pc/box |
| 52Q032 | 3.2 | . | . | 1/8" | E4 | | 25 | 10 | 50 |
| 52Q04 | 4 | . | . | 5/32" | E5 | 4 | 25 | 10 | 50 |
| 52Q045 | 4.5 | . | . | | | | 25 | 10 | 50 |
| 52Q05 | 5 | . | . | 3/16" | E6 | 5 | 25 | 12 | 50 |
| 52Q055 | 5.5 | . | . | 7/32" | E7 | | 25 | 12 | 50 |
| 52Q06 | 6 | . | . | | E8 | 6 | 25 | 12 | 50 |
| 52Q07 | 7 | . | . | 9/32" | | 7 | 25 | 12 | 50 |
| 52Q08 | 8 | . | . | 5/16" | E10 | 8 | 25 | 12 | 50 |
| 52Q09 | 9 | . | . | 11/32" | E11 | 9 | 25 | 18 | 50 |
| 52Q10 | 10 | . | . | 3/8" | E12 | 10 | 25 | 18 | 50 |
| 52Q11 | 11 | . | . | 7/16" | E14 | 11 | 25 | 24 | 50 |
| 52Q12 | 12 | . | . | 15/32" | | 12 | 25 | 28 | 50 |
| 52Q13 | 13 | . | . | 1/2" | E16 | | 25 | 32 | 50 |
| 52Q14 | 14 | . | . | 9/16" | E18 | 14 | 25 | 36 | 50 |



1/4" DR. Spline deep socket

| 52Q50 | | | | | | | | | |
|--------------|------|--------|---------|--------|--------|-----|---------|----|--------|
| Part no. | size | 6point | 12point | SAE | E-Torx | XZN | l mm | g | pc/box |
| 52Q5004 | 4 | . | . | 5/32" | E5 | 4 | 50 | 14 | 50 |
| 52Q50045 | 4.5 | . | . | | | | 50 | 16 | 50 |
| 52Q5005 | 5 | . | . | 3/16" | E6 | 5 | 50 | 16 | 50 |
| 52Q50055 | 5.5 | . | . | 7/32" | E7 | | 50 | 20 | 50 |
| 52Q5006 | 6 | . | . | | E8 | 6 | 50 | 20 | 50 |
| 52Q5007 | 7 | . | . | 9/32" | | 7 | 50 | 20 | 50 |
| 52Q5008 | 8 | . | . | 5/16" | E10 | 8 | 50 | 24 | 50 |
| 52Q5009 | 9 | . | . | 11/32" | E11 | 9 | 50 | 30 | 40 |
| 52Q5010 | 10 | . | . | 3/8" | E12 | 10 | 50 | 36 | 30 |
| 52Q5011 | 11 | . | . | 7/16" | E14 | 11 | 50 | 46 | 30 |
| 52Q5012 | 12 | . | . | 15/32" | | 12 | 50 | 50 | 20 |
| 52Q5013 | 13 | . | . | 1/2" | E16 | | 50 | 52 | 20 |
| 52Q5014 | 14 | . | . | 9/16" | E18 | 14 | 50 | 56 | 20 |



1/4" DR. Swivel handle

| 8012140 | | | |
|----------------|----------|-----|--------|
| Part no. | l mm | g | pc/box |
| 8012140 | 140-5.5" | 118 | 10 |

* Spare part available



1/4" DR. Ratchet handle-32 teeth

| 80226 | | | |
|--------------|---------|-----|--------|
| Part no. | l mm | g | pc/box |
| 80226 | 137 | 124 | 1 |

* Spare part available



1/4" DR. Ratchet handle-24 teeth

| 80222 | | | |
|--------------|---------|-----|--------|
| Part no. | l mm | g | pc/box |
| 80222 | 155 | 150 | 1 |

* Spare part available



1/4" DR. 72 teeth Ratchet handle

| 80229 | | | |
|--------------|---------|-----|--------|
| Part no. | l mm | g | pc/box |
| 80229 | 115 | 132 | 1 |

* Spare part available



1/4" DR. Ratchet handle-36 teeth-Thin

| 80224 | | | |
|--------------|---------|-----|--------|
| Part no. | l mm | g | pc/box |
| 80224 | 125 | 142 | 1 |

* Spare part available



1/4" DR. Ratchet handle-24 teeth

| 802211 | | | |
|---------------|---------|-----|--------|
| Part no. | l mm | g | pc/box |
| 802211 | 140 | 168 | 1 |

* Spare part available

NEW



Mini Ratchet handle

| 802214 | | | |
|---------------|---------|-----|--------|
| Part no. | l mm | g | pc/box |
| 802214 | 130 | 120 | 1 |

* Spare part available



1/4" DR. Ratchet handle-36 teeth-RD

| 80225 | | | |
|--------------|---------|-----|--------|
| Part no. | l mm | g | pc/box |
| 80225 | 135 | 141 | 1 |



1/4" DR. Ratchet handle-20 teeth

| 802215 | <i>l</i> | | |
|---------------|----------|-----|--------|
| Part no. | mm | g | pc/box |
| 802215 | 130 | 120 | 1 |

* Spare part available



1/4" DR. 72 teeth round ratchet handle

| 802222 | <i>l</i> | | |
|---------------|----------|-----|--------|
| Part no. | mm | g | pc/box |
| 802222 | 125 | 114 | 1 |

* Spare part available



1/4" DR. Bit ratchet handle-20 teeth

| 802202 | <i>l</i> | | | |
|---------------|--------------|-----|-----|--------|
| Part no. | size | mm | g | pc/box |
| 802202 | For 1/4" bit | 130 | 118 | 1 |

* Spare part available



1/4" DR. Extension

| 8042 | <i>l</i> | | |
|--------------------|----------|-----|--------|
| Part no. | mm | g | pc/box |
| 8042050 | 50-2" | 23 | 20 |
| 8042075 NEW | 75-3" | 34 | 10 |
| 8042100 | 100-4" | 46 | 10 |
| 8042125 NEW | 125-5" | 54 | 10 |
| 8042150 | 150-6" | 66 | 10 |
| 8042200 NEW | 200-8" | 87 | 10 |
| 8042250 | 250-10" | 110 | 10 |
| 8042350 NEW | 350-14" | 139 | 10 |



1/4" DR. Flexible ratchet handle-20 teeth

| 802218 | <i>l</i> | | |
|---------------|----------|-----|--------|
| Part no. | mm | g | pc/box |
| 802218 | 125 | 146 | 1 |

* Spare part available



1/4" DR. 72 teeth flexible round ratchet handle

| 802223 | <i>l</i> | | |
|---------------|----------|-----|--------|
| Part no. | mm | g | pc/box |
| 802223 | 150 | 126 | 1 |

* Spare part available



1/4" DR. Flexible bit ratchet handle-20 teeth

| 802202F | <i>l</i> | | | |
|----------------|--------------|-----|-----|--------|
| Part no. | size | mm | g | pc/box |
| 802202F | For 1/4" bit | 125 | 142 | 1 |

* Spare part available



1/4" DR. Wobble extension

| 8042..W | <i>l</i> | | |
|----------------|----------|-----|--------|
| Part no. | mm | g | pc/box |
| 8042050W | 50-2" | 23 | 20 |
| 8042075W | 75-3" | 34 | 10 |
| 8042100W | 100-4" | 46 | 10 |
| 8042150W | 150-6" | 66 | 10 |
| 8042225W | 225-9" | 101 | 10 |
| 8042250W | 250-10" | 110 | 10 |



1/4" DR. Stubby ratchet handle-20 teeth

| 802219 | <i>l</i> | | |
|---------------|----------|-----|--------|
| Part no. | mm | g | pc/box |
| 802219 | 95 | 104 | 1 |

* Spare part available



NEW



1/4" DR. Quick-release 72 teeth round ratchet handle

| 802224 | <i>l</i> | | |
|---------------|----------|-----|--------|
| Part no. | mm | g | pc/box |
| 802224 | 138 | 108 | 1 |

* Spare part available



NEW



1/4" DR. Swivel ratchet handle

| 802234 | <i>l</i> | | |
|---------------|----------|-----|--------|
| Part no. | mm | g | pc/box |
| 802234 | 200 | 170 | 1 |



1/4" DR. Sliding T handle

| 8032115 | <i>l</i> | | |
|----------------|----------|----|--------|
| Part no. | mm | g | pc/box |
| 8032115 | 115 | 42 | 10 |



Adaptor for 1/4" DR. Extension

| 806 | <i>l</i> | | | |
|------------|------------------|----|----|--------|
| Part no. | size | mm | g | pc/box |
| 80622 | 1/4"(F)x1/4"(M) | 26 | 15 | 50 |
| 80632 | 3/8"(F) x1/4"(M) | 35 | 29 | 20 |

1/4" DR. T mini ratchet handle - 48 teeth

| 802220 | <i>l</i> | | |
|---------------|----------|----|--------|
| Part no. | mm | g | pc/box |
| 802220 | 110 | 77 | 10 |

* Spare part available



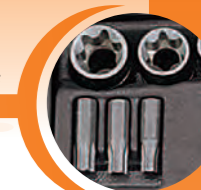

1/4" DR. Adaptor

| 8092 | | | | |
|------------------|------------------|----|----|--------|
| Part no. | size | mm | g | pc/box |
| 80922 NEW | 1/4"(F) x1/4"(F) | 26 | 18 | 25 |
| 80923 | 1/4"(F) x3/8"(M) | 26 | 18 | 25 |



1/4" Bit adaptor

| 8092 | | | | |
|-------------|-----------------|----|----|--------|
| Part no. | size | mm | g | pc/box |
| 8092225 | 1/4"Hex-1/4"Sq. | 25 | 8 | 10 |
| 8092230 | 1/4"Hex-1/4"Sq. | 30 | 10 | 10 |
| 8092250 | 1/4"Hex-1/4"Sq. | 50 | 16 | 50 |



1/4" Adaptor extension

| 80922175 | | | | |
|-----------------|-----------------|-----|----|--------|
| Part no. | size | mm | g | pc/box |
| 80922175 | 1/4"Hex-1/4"Sq. | 175 | 73 | 20 |



Adapter extension

| 80923036 | | | | |
|-----------------|-------------------|----|----|--------|
| Part no. | size | mm | g | pc/box |
| 80923036 | 1/4"(F) - 3/8"(M) | 36 | 20 | |



1/4" DR. Universal joint

| 80521 | | | | |
|--------------|----|----|--------|--|
| Part no. | mm | g | pc/box | |
| 80521 | 37 | 23 | 20 | |



1/4" DR. Universal socket

| 80525 | | | | |
|--------------|--------|----|----|--------|
| Part no. | socket | mm | g | pc/box |
| 8052506 | 6 | 39 | 22 | 20 |
| 8052507 | 7 | 39 | 24 | 20 |
| 8052508 | 8 | 39 | 24 | 20 |
| 8052509 | 9 | 39 | 24 | 20 |



1/4" DR. Universal deep socket

| 8052565 | | | | |
|----------------|--------|----|----|--------|
| Part no. | socket | mm | g | pc/box |
| 805256505 | 5 | 65 | 29 | 20 |
| 805256506 | 6 | 65 | 31 | 20 |
| 805256507 | 7 | 65 | 36 | 20 |
| 805256508 | 8 | 65 | 38 | 20 |
| 805256509 | 9 | 65 | 38 | 20 |
| 805256510 | 10 | 65 | 44 | 20 |
| 805256511 | 11 | 65 | 49 | 20 |
| 805256512 | 12 | 65 | 49 | 20 |
| 805256513 | 13 | 65 | 50 | 20 |



1/4" DR. Bit holder

| 81022 | | | | |
|--------------|------------------|----|----|--------|
| Part no. | size | mm | g | pc/box |
| 81022 | 1/4"(F) x1/4"(F) | 25 | 14 | 50 |



1/4" Magnetic bit holder

| 81022M | | | | |
|---------------|------------------|----|----|--------|
| Part no. | size | mm | g | pc/box |
| 81022M | 1/4"(F) x1/4"(F) | 25 | 14 | 50 |



1/4" DR. Flexible inhex extension

| 8111 | | | | |
|-------------|---------|-----|----|--------|
| Part no. | size | mm | g | pc/box |
| 8111 | 1/4"DR. | 145 | 61 | 10 |



1/4" DR. Flexible inhex extension

| 8112 | | | | |
|-------------|-----------------|-----|----|--------|
| Part no. | size | mm | g | pc/box |
| 8112 | 1/4"Hex-1/4"Hex | 175 | 73 | 10 |



1/4" Flexible spinner

| 8113 | | | | |
|-------------|---------|---------|-----|--------|
| Part no. | size | mm | g | pc/box |
| 8113 | 1/4"DR. | 275-11" | 151 | 10 |



1/4" DR. Magnetic socket pick-up

| 81225 | | | | |
|--------------|---------|----|----|--------|
| Part no. | size | mm | g | pc/box |
| 81225 | 1/4"DR. | 25 | 16 | 50 |



1/4" Magnetic inhex extension

| 812 | | | | |
|------------|-----------------|-----|----|--------|
| Part no. | size | mm | g | pc/box |
| 81260 | 1/4"Hex-1/4"Hex | 60 | 23 | 50 |
| 812175 | 1/4"Hex-1/4"Hex | 175 | 55 | 20 |



1/4" Magnetic QR bit holder

| 81260Q | | | | |
|---------------|-----------------|----|----|--------|
| Part no. | size | mm | g | pc/box |
| 81260Q | 1/4"Hex-1/4"Hex | 60 | 32 | 10 |



1/4" Magnetic QR bit holder

| 81280Q | | | | |
|---------------|-----------------|----|----|--------|
| Part no. | size | mm | g | pc/box |
| 81280Q | 1/4"Hex-1/4"Hex | 75 | 38 | 10 |

81280Q with a second magnet to keep screws always straight and centered.



1/4" DR. Spinner

| 8142 | | <i>l</i> | | |
|-------------|---------|----------|----|--------|
| Part no. | size | mm | g | pc/box |
| 8142 | 1/4"DR. | 100-4" | 99 | 10 |



1/4" DR. Quick-release bit spinner

| 8148 | | <i>l</i> | | |
|-------------|-----------|----------|-----|--------|
| Part no. | size | mm | g | pc/box |
| 8148 | 1/4"inhex | 150-6" | 105 | 10 |



1/4" DR. Spinner

| 8143 | | <i>l</i> | | |
|-------------|---------|----------|-----|--------|
| Part no. | size | mm | g | pc/box |
| 8143 | 1/4"DR. | 150-6" | 104 | 10 |

NEW



1/4"DR. Ratchet spinner

| 8149 | | <i>l</i> | | |
|-------------|--------|----------|-----|--------|
| Part no. | Drive | mm | g | pc/box |
| 8149 | 1/4"DR | 193 | 160 | 10 |



1/4" Magnetic Inhex Spinner

| 8144 | | <i>l</i> | | |
|-------------|-----------|----------|-----|--------|
| Part no. | size | mm | g | pc/box |
| 8144 | 1/4"inhex | 215 | 117 | 10 |

NEW



1/4"DR. Ratchet bit driver handle

| 8152R | | <i>l</i> | | |
|--------------|------------|----------|-----|--------|
| Part no. | size | mm | g | pc/box |
| 8152R | 1/4" inhex | 200 | 170 | 1 |

Combination Example:

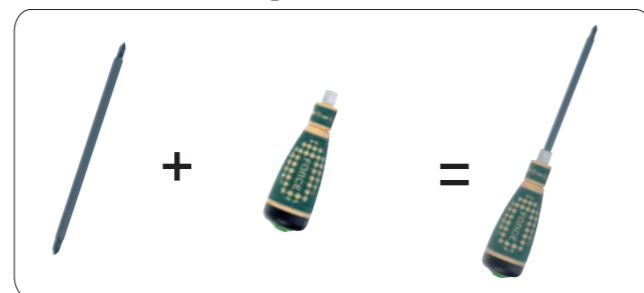

1/4" DR. Spinner

| 8145 | | <i>l</i> | | |
|-------------|---------|----------|----|--------|
| Part no. | size | mm | g | pc/box |
| 8145 | 1/4"DR. | 150-6" | 88 | 10 |



1/4" DR. Plastic hanger

| 8162 | | <i>l</i> | |
|-------------|---------|----------|---|
| Part no. | size | mm | g |
| 8162 | 1/4"DR. | 61 | 3 |



1/4" DR. Socket rail

| 8192 | | <i>l</i> | |
|-------------|-----|----------|-----|
| Part no. | PCS | mm | g |
| 819210 | 10 | 160 | 25 |
| 819212 | 12 | 200 | 32 |
| 819230 | 30 | 560 | 122 |



5pc 3/8" Accessory set

| | | | |
|----------------|---|--|------|
| 3051 | | | |
| Part no. | 20/17.5/18.5/1.3' | | 875g |
| 802313 | Content:3/8"DR. 1-Flex ratchet handle (round head) | | |
| 8073 16...20.6 | 2-Spark plug socket 16; 20.6 mm | | |
| 8043 044...075 | 2-Extension bar 44; 75 mm | | |

5pc 3/8" Accessory set

| | | | |
|------------------|--|--|------|
| 3051M NEW | | | |
| Part no. | 20/17.5/18.5/1.3' | | 875g |
| Changed Items | Content:3/8"DR. 2-Magnetic spark plug socket 16; 20.6 mm | | |
| 8073 16M...20.6M | | | |



5pc 3/8" Star socket set

| | | | |
|-------------|--|--|------|
| 3062 | | | |
| Part no. | Socket 80/13.6/14.6/1.4' | | 170g |
| 536 08...16 | Content:3/8"DR. 5-Star socket E8; E10; E12; E14; E16 | | |



6pc 3/8" Star socket set

| | | | |
|-------------|---|--|------|
| 3064 | | | |
| Part no. | Socket 80/15.8/16.8/1.4' | | 197g |
| 536 06...14 | Content:3/8"DR. 6-Star socket E6; E7; E8; E10; E12; E14 | | |



6pc 3/8" Hex socket bit set (MM)

| | | | |
|----------------|---|--|------|
| 3065 | | | |
| Part no. | Bit 40/12.6/13.6/1.1' | | 315g |
| 334050 04...10 | Content:3/8"DR. 6-Hex socket bit (50mmL) 4; 5; 6; 7; 8; 10 mm | | |

6pc 3/8" Hex socket bit set (SAE)

| | | | |
|-------------------|--|--|------|
| 3065S | | | |
| Part no. | Bit 40/12.6/13.6/1.1' | | 315g |
| 334050 1.8...7.16 | Content:3/8"DR. 6-Hex socket bit (50mmL) 1/8"; 3/16"; 1/4"; 5/16"; 3/8"; 7/16" | | |



7pc 3/8" Star bit set

| | | | |
|---------------|---|--|------|
| 3071 | | | |
| Part no. | Bit 100/14.5/15.5/1.8' | | 145g |
| 15635 25...55 | Content:3/8"DR. 6-5/16" Star bit (35mmL) T25; T30; T40; T45; T50; T55 | | |
| 81035 | 1-Bit holder 3/8"DR.x5/16" | | |



7pc 3/8" Star socket set

| | | | |
|-------------|---|--|------|
| 3072 | | | |
| Part no. | Socket 40/12.3/13.3/1' | | 308g |
| 536 04...11 | Content:3/8"DR. 7-Star socket E4; E5; E6; E7; E8; E10; E11 | | |
| 3073 | | | |
| Part no. | Socket 40/12.5/13.5/1' | | 313g |
| 536 05...14 | Content:3/8"DR. 7-Star socket E5; E6; E7; E8; E10; E12; E14 | | |



7pc Star socket set

| | | | |
|-------------|---|--|------|
| 3074 | | | |
| Part no. | Socket 80/14.6/15.6/1.4' | | 182g |
| 526 06...08 | Content:1/4"DR. & 3/8"DR. 6-Star socket 1/4"DR.: E6; E7; E8 | | |
| 536 10...16 | 3/8"DR.: E10; E12; E14; E16 | | |



7pc 3/8" Hex socket bit set (MM)

| | | | |
|----------------|---|--|------|
| 3075 | | | |
| Part no. | Bit 48/18.1/19.1/1.4' | | 377g |
| 334050 03...10 | Content:3/8"DR. 7-Hex socket bit (50mmL) 3;4;5;6;7;8;10mm | | |

7pc 3/8" Hex socket bit set (SAE)

| | | | |
|-------------------|--|--|------|
| 3075S | | | |
| Part no. | Bit 48/18.1/19.1/1.4' | | 377g |
| 334050 1.8...3.8 | Content:3/8"DR. 7-Hex socket bit (50mmL) 1/8"; 5/32"; 3/16"; 7/32"; 1/4"; 5/16"; 3/8" | | |
| 3075SK | | | |
| Part no. | Bit 48/21.0/22.0/1.4' | | 437g |
| 334050 3.16...1.2 | Content:3/8"DR. 7-Hex socket bit (50mmL) 3/16"; 7/32"; 1/4"; 5/16"; 3/8"; 7/16"; 1/2" | | |

NEW



7pc 3/8" Hex ball point socket bit set (62mmL)

| | | | |
|----------------|--|--|------|
| 3076 | | | |
| Part no. | Bit 40/16.5/17.5/1.6' | | 413g |
| 335062 03...10 | Content:3/8"DR. 7-3/8" Hex ball point socket bit 3, 4, 5, 6, 7, 8, 10 mm (62mmL) | | |

7pc 3/8" Hex ball point socket bit set (100mmL)

| | | | |
|----------------|---|--|------|
| 3076L | | | |
| Part no. | Bit 40/21.5/22.5/1.8' | | 538g |
| 335100 03...10 | Content:3/8"DR. 7-3/8" Hex ball point socket bit 3, 4, 5, 6, 7, 8, 10 mm (100mmL) | | |



7pc 3/8" Universal deep socket set

| | | | |
|-------------------|---|-------------------|------|
| 3077S | | | |
| Part no. | Socket | 20/16.4/17.4/1.3' | 820g |
| 8053585 3.8...3.4 | Content:3/8"DR. 7-3/8" Universal deep socket (85mmL) 3/8"; 7/16"; 1/2"; 9/16"; 5/8"; 11/16"; 3/4" | | |



7pc Ratchet handle set

| | | |
|--------------|---|-------|
| 30711 | | |
| Part no. | 6/14.1/15.1/0.9' | 2350g |
| 6473365 | Content:3/8"DR. 1-Torque wrench | |
| 802318 | 1-Flexible ratchet handle | |
| 802315 | 1-Ratchet handle | |
| 802319 | 1-Stubby ratchet handle | |
| 8073 | 3-Magnetic spark plug socket 16M...20.6M 16; 18; 20.6 mm | |



7pc Ribe socket set

| | | | |
|----------------|--|-------------------|-------|
| 3078 | | | |
| Part no. | Bit | 20/20.0/21.0/1.2' | 1000g |
| 339090 06...10 | Content:3/8" & 1/2"DR. 4-3/8"DR. Ribe socket bit (90mmL) M6; M7; M8; M10 | | |
| 349100 12...14 | 3-1/2"DR. Ribe socket bit (100mmL) M12; M13; M14 | | |



7pc Ratchet handle set

| | | |
|----------------|--|-------|
| 30712 | | |
| Part no. | 6/14.7/15.7/0.9' | 2450g |
| 6473365 | Content:3/8"DR. 1-Torque wrench | |
| 80232 | 1-24 teeth ratchet handle | |
| 802319 | 1-Stubby ratchet handle | |
| 802323 | 1-72 teeth flexible round ratchet handle | |
| 8073 16...20.6 | 3-Spark plug socket 16; 18; 20.6mm | |



7pc 3/8" Universal socket set

| | | | |
|-----------------|---|-------------------|------|
| 30710S | | | |
| Part no. | Socket | 20/12.0/13.0/1.2' | 600g |
| 80535 3.8...3.4 | Content:3/8"DR. 7-Universal socket (42mmL) 3/8"; 7/16"; 1/2"; 9/16"; 5/8"; 11/16"; 3/4" | | |

NEW



7pc 3/8" Magnetic spark plug socket set

| | | |
|------------------|--|-------|
| K30714 | | |
| Part no. | 12/14.9/15.9/1.4' | 1242g |
| 8073 14M...20.6M | Content:3/8"DR. 4-Magnetic spark plug socket 14; 16; 18; 20.6 mm | |
| 802318 | 1-Flexible ratchet handle | |
| 80430 44W...75W | 2-Wobble extension 44; 75 mm | |

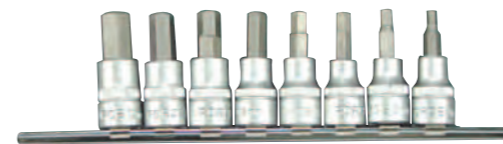

8pc 3/8" Hex socket bit set

| | | | |
|----------------|--|-------------------|------|
| 3081 | | | |
| Part no. | Bit | 60/27.4/28.4/1.7' | 456g |
| 334050 04...12 | Content:3/8"DR. 8-Hex socket bit (50mmL) 4; 5; 6; 7; 8; 9; 10; 12 mm | | |



8pc 3/8" Deep socket set (MM)

| | | | |
|---------------|---|-------------------|------|
| 3082 | | | |
| Part no. | Socket | 24/15.8/16.8/1.4' | 660g |
| 53563 08...19 | Content:3/8"DR. 8-6pt. Flank deep socket (63mmL) 8; 10; 12; 13; 14; 16; 17; 19 mm | | |

8pc 3/8" Deep socket set (SAE)

| | | | |
|------------------|--|-------------------|------|
| 3082S | | | |
| Part no. | Socket | 24/15.8/16.8/1.4' | 660g |
| 53563 5.16...3.4 | Content:3/8"DR. 8-6pt. Flank deep socket (63mmL) 5/16"; 3/8"; 7/16"; 1/2"; 9/16"; 5/8"; 11/16"; 3/4" | | |



9pc 3/8" Star socket set

| | | | |
|-------------|--|-------------------|------|
| 3091 | | | |
| Part no. | Socket | 60/16.3/17.3/1.7' | 272g |
| 536 04...14 | Content:3/8"DR. 9-Star socket E4; E5; E6; E7; E8; E10; E11; E12; E14 | | |



9pc Star socket set

| | | | |
|-------------|---|-------------------|------|
| 3092 | | | |
| Part no. | Socket | 60/16.0/17.0/1.3' | 265g |
| 526 04...08 | Content:1/4"DR. & 3/8"DR. 9-Star socket 1/4"DR.: E4; E5; E6; E7; E8 | | |
| 536 10...14 | 3/8"DR.: E10; E11; E12; E14 | | |



9pc 3/8" Socket set(MM)

| | | | |
|-------------|--|-------------------|------|
| 3093 | | | |
| Part no. | Socket | 40/22.0/23.0/1.7' | 550g |
| 535 09...19 | Content:3/8"DR. 9-6pt. Flank socket 9; 10; 11; 12; 13; 14; 15; 17; 19 mm | | |

9pc 3/8" Socket set(SAE)

| | | | |
|-----------------|--|-------------------|------|
| 3093S | | | |
| Part no. | Socket | 40/22.0/23.0/1.7' | 550g |
| 535 3.8...15.16 | Content:3/8"DR. 9-6pt. Flank socket 3/8"; 7/16"; 1/2"; 9/16"; 5/8"; 11/16"; 3/4"; 13/16"; 15/16" | | |



9pc 3/8" Star bit set

| | | | |
|---------------|---|--------------------|------|
| 3094 | | | |
| Part no. | Bit | 100/18.2/19.2/1.6' | 182g |
| 17630 20...60 | Content:3/8"DR. 8-10mm Star bit (30mmL) T20; T25; T30; T40; T45; T50; T55; T60 | | |
| 81037 | 1-Bit holder 3/8"DR.x10mm | | |



9pc 1/4" & 3/8" Five-sided star tamperproof socket bit set

| | | | |
|---------------|---|-----------------|------|
| 3095 | | | |
| Part no. | Bit | 30/7.0/8.0/0.9' | 233g |
| 32F32 10...40 | Content:1/4"DR. & 3/8"DR. 7-1/4"DR.: Five-sided star tamperproof socket bit TS10; TS15; TS20; TS25; TS27; TS30; TS40 | | |
| 33F50 45...50 | 2-3/8"DR.: Five-sided star tamperproof socket bit TS45; TS50 | | |



10pc Star socket set

| | | | |
|-------------|---|-------------------|------|
| 3101 | | | |
| Part no. | Socket | 60/15.5/16.5/1.4' | 258g |
| 526 04...08 | Content:1/4" & 3/8"DR. 10-Star socket 1/4"DR.: E4; E5; E6; E7; E8 | | |
| 536 10...18 | 3/8"DR.: E10; E12; E14; E16; E18 | | |



10pc 3/8" Universal deep socket set

| | | | |
|-----------------|---|-----------------|-------|
| 3103 | | | |
| Part no. | Socket | 15/17.1/18.1/1' | 1140g |
| 8053585 10...19 | Content:3/8"DR. 10-Universal deep socket (85mmL) 10; 11; 12; 13; 14; 15; 16; 17; 18; 19 mm | | |



10pc 3/8" Universal socket set

| | | | |
|---------------|---|----------------|------|
| 3105 | | | |
| Part no. | Socket | 15/9.8/10.8/1' | 650g |
| 80535 10...19 | Content:3/8"DR. 10-Universal socket 10; 11; 12; 13; 14; 15; 16; 17; 18; 19 mm | | |



10pc Spline deep socket set

| | | | |
|---------------|---|-------------------|------|
| 3108Q | | | |
| Part no. | Socket | 24/20.5/21.5/0.9' | 854g |
| 53Q63 08...19 | Content:3/8"DR. 10-Spline deep socket (63mmL) 8; 10; 11; 12; 13; 14; 15; 16; 17; 19 mm | | |



11pc 3/8" Star deep socket set

| | | | |
|---------------|--|-------------------|------|
| 3112 | | | |
| Part no. | Socket | 24/15.6/16.6/1.9' | 650g |
| 53655 04...07 | Content:3/8"DR. 11-Star deep socket E4; E5; E6; E7 (55mmL) | | |
| 53663 08...18 | E8; E10; E11; E12; E14; E16; E18 (63mmL) | | |



11pc 3/8" 12pt. Flank socket set

| | | | |
|-------------|--|---------------|------|
| 3111 | | | |
| Part no. | Socket | 20/8.3/9.3/1' | 416g |
| 539 08...18 | Content:3/8"DR. 11-12pt. Flank socket 8; 9; 10; 11; 12; 13; 14; 15; 16; 17; 18 mm | | |

11pc 3/8" 12pt. Flank socket set (SAE)

| | | | |
|------------------|--|---------------|------|
| 3113S NEW | | | |
| Part no. | Socket | 20/8.3/9.3/1' | 416g |
| 539 1.4...7.8 | Content:3/8"DR. 11-12pt. Flank socket 1/4"; 5/16"; 3/8"; 7/16"; 1/2"; 9/16"; 5/8"; 11/16"; 3/4"; 13/16"; 7/8" | | |



11pc Go-through ratchet socket set (SAE)

| | | | |
|-------------|---|-------------------|------|
| 3114 | | | |
| Part no. | Socket | 18/17.5/19.5/1.8' | 972g |
| | Content:3/8"DR. 7- Go-through socket 3/8"; 7/16"; 1/2"; 9/16"; 5/8"; 11/16"; 3/4" 2- Push Adaptor 3/8"; 1/4" 1- Extension bar 75mmL 1- 72 teeth 3/8" go-through reverse combination ratchet | | |



12pc 3/8" Deep socket set

| | | | |
|---------------|---|----------------|-------|
| 3121 | | | |
| Part no. | Socket | 6/7.2/8.2/0.9' | 1200g |
| 53563 08...22 | Content:3/8"DR. 12-6pt. Flank deep socket (63mmL) 8; 10; 11; 12; 13; 14; 15; 16; 17; 18; 19; 22 mm | | |



12pc Spline socket set

| | | | |
|--------------|--|-------------------|------|
| 3122Q | | | |
| Part no. | Socket | 36/21.2/22.2/1.3' | 588g |
| 53Q 08...22 | Content:3/8"DR. 12-Spline socket 8; 10; 11; 12; 13; 14; 15; 16; 17; 18; 19; 22 mm | | |



15pc Surface drive deep socket set

| | | | |
|--------------------------------|--|-------------------|------|
| 3151 | | | |
| Part no. | Socket | 20/18.4/19.4/1.2' | 920g |
| 52750 08...13 53763 08...19 | Content:1/4" & 3/8"DR. 15-Surface drive deep socket 1/4"DR.: 8; 9; 10; 11; 12; 13 mm 3/8"DR.: 8; 10; 11; 12; 13; 14; 15; 17; 19 mm | | |



12pc 3/8" 12pt. Socket and extension set

| | | | |
|--|--|-------------------|-------|
| K3125 | | | |
| Part no. | Socket | 12/16.8/17.8/1.4' | 1.4kg |
| 53963 08...14 8073 18...20.6 80531 8033165 8043250 | Content:3/8"DR. 7-12pt. Flank deep socket 8; 9; 10; 11; 12; 13; 14mm 2-Spark plug socket 18; 20.6mm 1-Universal joint 1-Sliding T handle 165mL 1-Extension 10" | | |



17pc Star set

| | | | |
|--|--|--------------------|------|
| 3171 | | | |
| Part no. | Bit | 25/10.3/11.3/0.64' | 412g |
| 526 06...08 536 10...16 15630 10...55 81035 | Content:1/4"DR. & 3/8"DR. 7-Star socket 1/4"DR.: E6; E7; E8 3/8"DR.: E10; E12; E14; E16 9-5/16" Star bit (30mmL) T10; T15; T20; T25; T30; T40; T45; T50; T55 1-Bit holder 3/8"DR.(F)x5/16"(F) | | |

| | | | |
|---------------|---|--------------------|------|
| 3171T | | | |
| Part no. | Bit | 25/10.3/11.3/0.64' | 412g |
| 15730 10...55 | Content: 3/8"DR. 9-5/16" Star tamperproof bit (30mmL) T-10H; T-15H; T-20H; T-25H; T-30H; T-40H; T-45H; T-50H; T-55H | | |

Changed Items



14pc Go-through ratchet socket set (MM)

| | | | |
|-------------|--|-------------------|-------|
| 3142 | | | |
| Part no. | Socket | 18/19.0/21.0/1.8' | 1050g |
| | Content:3/8"DR. 10-Go-through socket 10; 11; 12; 13; 14; 15; 16; 17; 18; 19 mm 2-Push Adaptor 3/8"; 1/4" Extension bar 75mmL 1-72 teeth 3/8" go-through reverse 1-combination ratchet | | |



19pc 6pt. Flank socket set (SAE)

| | | | |
|-----------------------------------|---|------------------|-------|
| 3193 | | | |
| Part no. | Socket | 6/10.6/11.6/0.9' | 1760g |
| 535 1.4...7.8 53563 5.16...3.4 | Content:3/8"DR. 11-6pt. Flank socket 1/4"; 5/16"; 3/8"; 7/16"; 1/2"; 9/16"; 5/8"; 11/16"; 3/4"; 13/16"; 7/8" 8-6pt. Flank deep socket (63mmL) 5/16"; 3/8"; 7/16"; 1/2"; 9/16"; 5/8"; 11/16"; 3/4" | | |



21pc Go-through ratchet socket set (SAE & MM)

| | | | |
|-------------|--|-------------------|-------|
| 3213 | | | |
| Part no. | Socket | 12/20.5/22.5/2.5' | 1710g |
| | Content:3/8"DR. 17- Go-through socket 3/8"; 7/16"; 1/2"; 9/16"; 5/8"; 11/16"; 3/4" 10; 11; 12; 13; 14; 15; 16; 17; 18; 19 mm 2- Push Adaptor 3/8"; 1/4" 1- Extension bar 75mmL 1- 72 teeth 3/8" go-through reverse combination ratchet | | |



21pc 3/8" Socket set (SAE)

| | | | |
|--|---|------------------|-------|
| 3212 | | | |
| Part no. | Socket | 6/12.2/13.2/0.9' | 2030g |
| 535 1.4...7.8 80232 8033165 8043 075...250 80531 8073 16...20.6 | Content:3/8"DR. 13-6pt. Flank socket 1/4"; 5/16"; 3/8"; 7/16"; 1/2"; 9/16"; 19/32"; 5/8"; 11/16"; 3/4"; 25/32"; 13/16"; 7/8" 1-Ratchet handle 1-Sliding T handle 3-Extension bar 3"; 6"; 10" 1-Universal joint 2-Spark plug socket 16; 20.6 mm | | |



22pc Surface drive socket set

| | | | |
|----------------------------|---|--------------------|------|
| 3222 | | | |
| Part no. | Socket | 20/12.5/13.5/0.94' | 625g |
| 527 06...13 537 06...19 | Content:1/4"DR. & 3/8"DR. 22-Surface drive socket 1/4"DR.: 6; 7; 8; 9; 10; 11; 12; 13mm 3/8"DR.: 6; 7; 8; 9; 10; 11; 12; 13; 14; 15; 16; 17; 18; 19 mm | | |



22pc 3/8" Universal socket set

| | | | |
|--------------------|---|------------------|-------|
| 3224 | | | |
| Part no. | Socket | 6/17.2/18.2/0.9' | 2860g |
| 80535 10...19 | Content:3/8"DR. 10-Universal socket (42mmL) 10; 11; 12; 13; 14; 15; 16; 17; 18; 19 mm | | |
| 8053585 10...19 | 10-Universal deep socket (85mmL) 10; 11; 12; 13; 14; 15; 16; 17; 18; 19 mm | | |
| 8073 16UM...20.6UM | 2-Universal magnetic spark plug 16; 20.6 mm | | |



23pc 3/8" Socket set

| | | | |
|----------------|--|-----------------|-------|
| 3232 | | | |
| Part no. | Socket | 10/19.0/20.0/1' | 1900g |
| 535 06...22 | Content:3/8"DR. 17-6pt. Flank socket 6; 7; 8; 9; 10; 11; 12; 13; 14; 15; 16; 17; 18; 19; 20; 21; 22 mm | | |
| 80239 | 1-72 teeth ratchet handle | | |
| 8043 075...225 | 3-Extension bar 3"; 6"; 9" | | |
| 80531 | 1-Universal joint | | |
| 80643 | 1-Adaptor for extension 1/2"(F)x3/8"(M) | | |

| | | | |
|----------------------|---|-----------------|-------|
| 3232-7 | | | |
| Part no. | Socket | 10/18.5/19.5/1' | 1850g |
| Changed Items | Content:3/8"DR. 17-Surface drive socket 6; 7; 8; 9; 10; 11; 12; 13; 14; 15; 16; 17; 18; 19; 20; 21; 22 mm | | |

| | | | |
|----------------------|---|-----------------|-------|
| 3232-9 | | | |
| Part no. | Socket | 10/18.5/19.5/1' | 1850g |
| Changed Items | Content:3/8"DR. 17-12pt. Flank socket 6; 7; 8; 9; 10; 11; 12; 13; 14; 15; 16; 17; 18; 19; 20; 21; 22 mm | | |



24pc 3/8" Socket set

| | | | |
|----------------|---|------------------|-------|
| 3251 | | | |
| Part no. | Socket | 6/13.9/14.9/0.9' | 2320g |
| 537 06...22 | Content:3/8"DR. 17-Surface drive socket 6; 7; 8; 9; 10; 11; 12; 13; 14; 15; 16; 17; 18; 19; 20; 21; 22 mm | | |
| 80232 | 1-Ratchet handle | | |
| 8043 075...150 | 2-Extension bar 3"; 6" | | |
| 80531 | 1-Universal joint | | |
| 8033165 | 1-Sliding T handle | | |
| 8073 16...20.6 | 2-Spark plug socket 16; 20.6 mm | | |

| | | | |
|----------------------|--|------------------|-------|
| 3251-5 | | | |
| Part no. | Socket | 6/14.0/15.0/0.9' | 2330g |
| Changed Items | Content:3/8"DR. 17-6pt. Flank socket 6; 7; 8; 9; 10; 11; 12; 13; 14; 15; 16; 17; 18; 19; 20; 21; 22 mm | | |

| | | | |
|----------------------|---|------------------|-------|
| 3251-9 | | | |
| Part no. | Socket | 6/14.5/15.5/0.9' | 2420g |
| Changed Items | Content:3/8"DR. 17-12pt. Flank socket 6; 7; 8; 9; 10; 11; 12; 13; 14; 15; 16; 17; 18; 19; 20; 21; 22 mm | | |



| | | | |
|----------------------|--|------------------|-------|
| 3251-72 | | | |
| Part no. | Socket | 6/16.4/17.4/0.9' | 2730g |
| Changed Items | Content:3/8"DR. 1-72 teeth ratchet handle | | |

| | | | |
|----------------------|--|------------------|-------|
| 3251-72-5 | | | |
| Part no. | Socket | 6/16.4/17.4/0.9' | 2730g |
| Changed Items | Content:3/8"DR. 17-6pt. Flank socket 6; 7; 8; 9; 10; 11; 12; 13; 14; 15; 16; 17; 18; 19; 20; 21; 22 mm | | |
| 80239 | 1-72 teeth ratchet handle | | |



| | | | |
|----------------------|--|------------------|-------|
| 3251-5-18 | | | |
| Part no. | Socket | 6/16.4/17.4/0.9' | 2733g |
| Changed Items | Content:3/8"DR. 17-6pt. Flank socket 6; 7; 8; 9; 10; 11; 12; 13; 14; 15; 16; 17; 18; 19; 20; 21; 22 mm | | |
| 802318 | 1-Flexible ratchet handle | | |

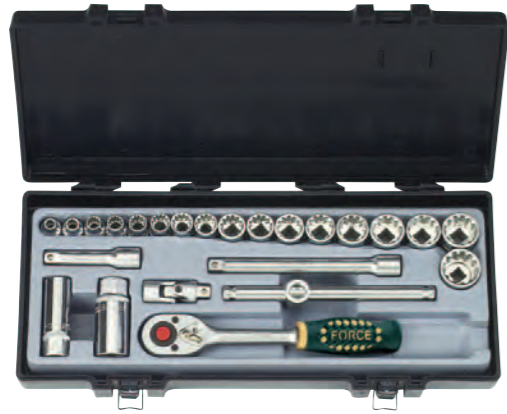

24pc 3/8" Spline socket set

| | | | |
|----------------|---|------------------|-------|
| 3251Q | | | |
| Part no. | Socket | 6/14.3/15.3/0.9' | 2380g |
| 53Q 06...22 | Content:3/8"DR. | | |
| 80232 | 17- Spline socket | | |
| 8043 075...150 | 6; 7; 8; 9; 10; 11; 12; 13; 14; 15; 16; 17; 18; 19; 20; 21; 22 mm | | |
| 80531 | 1- Ratchet handle | | |
| 8033165 | 2- Extension bar 3"; 6" | | |
| 8073 16...20.6 | 1- Universal joint | | |
| | 1- Sliding T bar | | |
| | 2- Spark plug socket 16mm; 20.6mm | | |



26pc 3/8" Socket set

| | | | |
|----------------|---|-------------------|-------|
| 3261 | | | |
| Part no. | Socket | 4/10.0/11.0/0.85' | 2500g |
| 535 06...24 | Content:3/8"DR. | | |
| 80232 | 18- 6pt. Flank socket | | |
| 8043 044...150 | 6; 7; 8; 9; 10; 11; 12; 13; 14; 15; 16; 17; 18; 19; 20; 21; 22; 24 mm | | |
| 8073 16...20.6 | 1- Ratchet handle | | |
| 80531 | 3- Extension bar 1-3/4"; 3"; 6" | | |
| 80643 | 2- Spark plug socket 16; 20.6 mm | | |
| | 1- Universal joint | | |
| | 1- Adaptor for extension 1/2"(F)x3/8"(M) | | |

| | | | |
|----------------------|---|-------------------|-------|
| 3261-7 | | | |
| Part no. | Socket | 4/10.0/11.0/0.85' | 2500g |
| Changed Items | Content:3/8"DR. | | |
| 537 06...24 | 18-Surface drive socket | | |
| | 6; 7; 8; 9; 10; 11; 12; 13; 14; 15; 16; 17; 18; 19; 20; 21; 22; 24 mm | | |
| 3261-9 | | | |
| Part no. | Socket | 4/10.0/11.0/0.85' | 2500g |
| Changed Items | Content:3/8"DR. | | |
| 539 06...24 | 18-12pt. Flank socket | | |
| | 6; 7; 8; 9; 10; 11; 12; 13; 14; 15; 16; 17; 18; 19; 20; 21; 22; 24 mm | | |

NEW



30pc 3/8" Socket set

| | | | |
|----------------|---|-------------------|-------|
| 3302 | | | |
| Part no. | Socket | 10/21.7/22.7/1.3' | 2170g |
| 535 06...24 | Content: 3/8"DR. | | |
| | 18-6pt. Flank socket | | |
| | 6; 7; 8; 9; 10; 11; 12; 13; 14; 15; 16; 17; 18; 19; 20; 21; 22; 24 mm | | |
| 53563 08...14 | 6-6pt. Flank deep socket | | |
| | 8; 9; 10; 12; 13; 14 mm | | |
| 80233 | 1-Ratchet handle 24 teeth-Thin | | |
| 8043 075...150 | 2-Extension 3"; 6" | | |
| 80531 | 1-Universal joint | | |
| 8073 16...20.6 | 2-Spark plug socket 16; 20.6 mm | | |



32pc Socket set (MM & SAE)

| | | | |
|-----------------|---|------------------|-------|
| 3322 | | | |
| Part no. | Socket | 6/15.0/16.0/0.9' | 2500g |
| 535 06...22 | Content:3/8"DR. | | |
| | 15- 6pt. Flank socket (MM) | | |
| | 6; 7; 8; 9; 10; 11; 12; 13; 14; 15; 16; 17; 18; 19; 20; 21; 22 mm | | |
| 535 1.4...13.16 | 11- 6pt. Flank socket (SAE) | | |
| | 1/4"; 3/8"; 1/2"; 9/16"; 5/8"; 11/16"; 13/16" | | |
| 8043 075...225 | 3- Extension bar 3"; 6"; 9" | | |
| 80643 | 1- Adaptor for extension 1/2"(F)x3/8"(M) | | |
| 80531 | 1- Universal joint | | |
| 802322 | 1- 72 teeth ratchet handle | | |
| 8073 16...20.6 | 2- Spark plug socket 16; 20.6 mm | | |



| | | | |
|----------------------|---------------------------|------------------|-------|
| 3322-15 | | | |
| Part no. | Socket | 6/15.0/16.0/0.9' | 2500g |
| Changed Items | Content:3/8"DR. | | |
| 802315 | 1-30 teeth ratchet handle | | |



| | | | |
|----------------------|--|------------------|-------|
| 3322-23 | | | |
| Part no. | Socket | 6/15.0/16.0/0.9' | 2500g |
| Changed Items | Content:3/8"DR. | | |
| 802323 | 1-72 teeth flexible round ratchet handle | | |



| | | | |
|----------------------|---------------------------|------------------|-------|
| 3322-24 | | | |
| Part no. | Socket | 6/15.0/16.0/0.9' | 2500g |
| Changed Items | Content:3/8"DR. | | |
| 80232 | 1-24 teeth ratchet handle | | |



35pc 3/8" Socket set

| 3351 | | | |
|----------------|---|--------------|-------|
| Part no. | Socket | 6/17/18/0.7' | 2833g |
| 539 06...21 | Content:3/8"DR. 15-12pt. Flank socket (MM) 6; 7; 8; 9; 10; 11; 12; 13; 14; 15; 16; 17; 18; 19; 21 mm | | |
| 539 1.4...7.8 | 11-12pt. Flank socket (SAE) 1/4"; 5/16"; 3/8"; 7/16"; 1/2"; 9/16"; 5/8"; 11/16"; 3/4"; 13/16"; 7/8" | | |
| 80232 | 1-Ratchet handle | | |
| 8043 075...225 | 3-Extension bar 3"; 6"; 9" | | |
| 80633 | 1-Adaptor for extension 3/8"(F)x3/8"(M) 2-Adaptor 3/8"DR.(F)x1/4"DR.(M) 3/8"DR.(F)x1/2"DR.(M) | | |
| 80932 | 1-Spark plug socket (16mm) | | |
| 80934 | 1-Universal joint | | |

| 3351-5 | | | |
|----------------------|--|--------------|-------|
| Part no. | Socket | 6/17/18/0.7' | 2833g |
| Changed Items | Content:3/8"DR. 15-6pt. Flank socket (MM) 6; 7; 8; 9; 10; 11; 12; 13; 14; 15; 16; 17; 18; 19; 21 mm | | |
| 535 1.4...7.8 | 11-6pt. Flank socket (SAE) 1/4"; 5/16"; 3/8"; 7/16"; 1/2"; 9/16"; 5/8"; 11/16"; 3/4"; 13/16"; 7/8" | | |

36pc 3/8" Combination socket set

| 3361 | | | |
|----------------|---|------------------|-------|
| Part no. | Socket | 6/18.2/19.2/0.9' | 3030g |
| 535 06...22 | Content:3/8"DR. 17-6pt. Flank socket 6; 7; 8; 9; 10; 11; 12; 13; 14; 15; 16; 17; 18; 19; 20; 21; 22 mm | | |
| 80239 | 1-72 teeth ratchet handle | | |
| 8043 075...225 | 3-Extension bar 3"; 6"; 9" | | |
| 8073 16...20.6 | 2-Spark plug socket 16; 20.6 mm | | |
| 80531 | 1-Universal joint | | |
| 80643 | 3-Adaptor for extension 1/2"(F)x3/8"(M) | | |
| 755 07...17 | 11-Combination wrench 7; 8; 9; 10; 11; 12; 13; 14; 15; 16; 17 mm | | |

| 3361-7 | | | |
|----------------------|--|------------------|-------|
| Part no. | Socket | 6/18.2/19.2/0.9' | 3030g |
| Changed Items | Content:3/8"DR. 17-Surface drive socket 6; 7; 8; 9; 10; 11; 12; 13; 14; 15; 16; 17; 18; 19; 20; 21; 22 mm | | |

| 3361-9 | | | |
|----------------------|--|------------------|-------|
| Part no. | Socket | 6/18.2/19.2/0.9' | 3030g |
| Changed Items | Content:3/8"DR. 17-12pt. Flank socket 6; 7; 8; 9; 10; 11; 12; 13; 14; 15; 16; 17; 18; 19; 20; 21; 22 mm | | |

39pc 1/4" & 3/8" socket set

| 3391 | | | |
|----------------|--|------------------|-------|
| Part no. | Socket | 6/13.6/14.6/0.7' | 2270g |
| 529 04...12 | Content:1/4" & 3/8"DR. 18-1/4"DR. 12pt. Flank Socket 4; 5; 6; 7; 8; 9; 10; 11; 12 mm | | |
| 529 3.16...1.2 | 3/16"; 7/32"; 1/4"; 9/32"; 5/16"; 11/32"; 3/8"; 7/16"; 1/2" | | |
| 539 09...19 | 16-3/8"DR. 12pt. Flank Socket 9; 10; 11; 12; 13; 14; 16; 17; 19 mm | | |
| 539 3.8...3.4 | 3/8"; 7/16"; 1/2"; 9/16"; 5/8"; 11/16"; 3/4" | | |
| 80232 | 1-Ratchet handle | | |
| 807316 | 1-Spark plug socket 5/8" (16mm) | | |
| 8043075 | 1-Extension bar 3" | | |
| 8145 | 1-Spinner handle | | |
| 80932 | 1-Adaptor 3/8"DR.(F)x1/4"DR.(M) | | |

| 3391-5 | | | |
|----------------------|---|------------------|-------|
| Part no. | Socket | 6/13.6/14.6/0.7' | 2270g |
| Changed Items | Content:1/4" & 3/8"DR. 18-1/4"DR. 6pt. Flank socket 4; 5; 6; 7; 8; 9; 10; 11; 12 mm 3/16"; 7/32"; 1/4"; 9/32"; 5/16"; 11/32"; 3/8"; 7/16"; 1/2" | | |
| 525 04...12 | 16-3/8"DR. 6pt. Flank socket 9; 10; 11; 12; 13; 14; 16; 17; 19 mm | | |
| 525 3.16...1.2 | 3/8"; 7/16"; 1/2"; 9/16"; 5/8"; 11/16"; 3/4" | | |

44pc 3/8" socket set

| 3441 | | | |
|----------------|---|------------------|-------|
| Part no. | Socket | 4/14.8/15.8/0.9' | 3700g |
| 535 06...22 | Content:3/8"DR. 17-6pt. Flank socket 6; 7; 8; 9; 10; 11; 12; 13; 14; 15; 16; 17; 18; 19; 20; 21; 22 mm | | |
| 53563 10...17 | 4-6pt. Flank deep socket 10; 13; 15; 17 mm 10-Socket bit (50mmL) Hex 4; 5; 6; 8; 10 mm Star T20; T25; T27; T30; T40 | | |
| 334050 04...10 | 1-72 teeth ratchet handle | | |
| 33650 20...40 | 1-Extension bar 3"; 6"; 9" | | |
| 80239 | 1-Universal joint | | |
| 8043 075...225 | 1-Adaptor for extension 1/2"(F)x3/8"(M) | | |
| 80531 | 1-Spark plug socket 16; 18; 20.6 mm | | |
| 80643 | 4-Hex key 1.27; 1.5; 2; 2.5 mm | | |



45pc 3/8" socket set

| Part no. | Socket | 4/20.2/21.2/0.9' | 5050g |
|-------------------|--------------------------------|---|-------|
| | Content:3/8"DR. | | |
| 535 08...22 | 15-6pt. Flank socket (MM) | 8; 9; 10; 11; 12; 13; 14; 15; 16; 17; 18; 19; 20; 21; 22 mm | |
| 53563 08...22 | 11-6pt. Flank deep socket (MM) | 8; 9; 10; 11; 12; 13; 14; 16; 17; 19; 22 mm | |
| 535 3.8...13.16 | 5-6pt. Flank socket (SAE) | 3/8"; 1/2"; 9/16"; 11/16"; 13/16" | |
| 53563 3.8...13.16 | 5-6pt. Flank deep socket (SAE) | 3/8"; 1/2"; 9/16"; 11/16"; 13/16" | |
| 8073 16...20.6 | 3-Spark plug socket | 16; 18; 20.6 mm | |
| 802311 | 1-Ratchet handle | | |
| 8013200B | 1-Bent flex handle | | |
| 8043 075...150 | 2-Extension bar 3"; 6" | | |
| 80643 | 1-Adaptor for extension | 1/2"(F)x3/8"(M) | |
| 80531 | 1-Universal joint | | |

NEW



51pc Socket set

| Part no. | Socket | 4/9.3/10.3/0.85' | 2334g |
|----------------|---------------------------------|---|-------|
| | Content: 1/4" & 3/8" DR. | | |
| | 1/4"DR. | | |
| 12330 04...065 | 3-Slotted bit | 4; 5.5; 6.5 mm | |
| 12630 10...40 | 7-Star bit | T10; T15; T20; T25; T27; T30; T40 | |
| 12130 0...3 | 4-Phillips bit | PH.0; PH.1; PH.2; PH.3 | |
| 12430 02...08 | 7-Hex bit | 2; 3; 4; 5; 6; 7; 8 mm | |
| 12230 1...3 | 3-Pozidriv bit | PZ.1; PZ.2; PZ.3 | |
| 81022 | 1-Bit holder 1/4"(F)x1/4"inhex | | |
| 8143 | 1-1/4"DR. Spinner | | |
| | 3/8"DR. | | |
| 535 06...22 | 17-6pt. Flank socket | 6; 7; 8; 9; 10; 11; 12; 13; 14; 15; 16; 17; 18; 19; 20; 21; 22 mm | |
| 80233 | 1-Ratchet handle 24th | | |
| 8073 16...20.6 | 2-Spark plug socket 16; 20.6 mm | | |
| 8043 075...150 | 2-Extension 3"; 6" | | |
| 80531 | 1-Universal joint | | |
| 81032 | 1-Bit holder 3/8"(F)x1/4"(F) | | |
| 80932 | 1-Adaptor 3/8"(F)x1/4"(M) | | |



52pc Star set

| Part no. | Bit | 6/18.0/19.0/0.9' | 3000g |
|---------------|--------------------------------------|---|-------|
| | Content: | | |
| 15630 20...55 | 13-15/16" Star bit | T20; T25; T30; T40; T45; T50; T55 (30mmL) | |
| 15670 20...50 | T20; T25; T30; T40; T45; T50 (70mmL) | | |
| 526 04...08 | 5-1/4"DR. Star socket | E4; E5; E6; E7; E8 | |
| 536 10...20 | 7-3/8"DR. Star socket | E10; E11; E12; E14; E16; E18; E20 | |
| 766 09...70 | 13-Star L key | T9; T10; T15; T20; T25; T27; T30; T40; T45; T50; T55; T60; T70 | |
| 12725 08...40 | 9-1/4" Star tamperproof bit | T-8H; T-10H; T-15H; T-20H; T-25H; T-27H; T-30H; T-35H; T-40H(25mmL) | |
| 34614055 | 1-Star socket bit T55 (140mmL) | | |
| 34605560 | 1-Star socket bit T60 (55mmL) | | |
| 34610070 | 1-Star socket bit T70 (100mmL) | | |
| 810 22...35 | 2-Bit holder | 1/4"DR.x1/4"; 3/8"DR.x5/16" | |



55pc 3/8" Combination set

| Part no. | Socket | 3/12.4/13.4/1.1' | 4130g |
|----------------------|---|---|-------|
| | Content:3/8"DR. | | |
| 537 06...24 | 18-Surface drive socket | 6; 7; 8; 9; 10; 11; 12; 13; 14; 15; 16; 17; 18; 19; 20; 21; 22; 24 mm | |
| 80232 | 1-Ratchet handle | | |
| 8043 044...150 | 3-Extension 1-3/4"; 3"; 6" | | |
| 8073 16...20.6 | 2-Spark plug socket 16; 20.6 mm | | |
| 80531 | 1-Universal joint | | |
| 80643 | 1-Adaptor for extension | 1/2"(F)x3/8"(M) | |
| 755 08...22 | 9-Combination wrench | 8; 10; 11; 12; 13; 14; 17; 19; 22 mm | |
| 5102A | 10 pc Hex key set | 1.27; 1.5; 2; 2.5; 3; 4; 5; 6; 8; 10 mm | |
| 764 0127A...10A | 10 pc Hex ball point extra long key set | 1.27; 1.5; 2; 2.5; 3; 4; 5; 6; 8; 10 mm | |
| 765 0127XLA...10XLA | | | |
| 3551-5 | | | |
| Part no. | Socket | 3/12.4/13.4/1.1' | 4130g |
| Changed Items | Content:3/8"DR. | | |
| 535 06...24 | 18-6pt. Flank socket | 6; 7; 8; 9; 10; 11; 12; 13; 14; 15; 16; 17; 18; 19; 20; 21; 22; 24 mm | |
| 3551-9 | | | |
| Part no. | Socket | 3/12.4/13.4/1.1' | 4130g |
| Changed Items | Content:3/8"DR. | | |
| 539 06...24 | 18-12pt. Flank socket | 6; 7; 8; 9; 10; 11; 12; 13; 14; 15; 16; 17; 18; 19; 20; 21; 22; 24 mm | |



5/16" Phillips bit

| 151 | | | | |
|---------------------------|------|----|----|--------|
| Part no. | size | mm | g | pc/box |
| 151301 | PH.1 | 30 | 10 | 10 |
| 151302 | PH.2 | 30 | 10 | 10 |
| 151303 | PH.3 | 30 | 10 | 10 |
| 151304 | PH.4 | 30 | 11 | 10 |
| 151321 | PH.1 | 32 | 10 | 10 |
| 151322 | PH.2 | 32 | 10 | 10 |
| 151323 | PH.3 | 32 | 12 | 10 |
| 151361 <small>NEW</small> | PH.1 | 36 | 13 | 10 |
| 151362 <small>NEW</small> | PH.2 | 36 | 13 | 10 |
| 151363 <small>NEW</small> | PH.3 | 36 | 13 | 10 |
| 151384 | PH.4 | 38 | 14 | 10 |
| 151802 <small>NEW</small> | PH.2 | 80 | 30 | 10 |
| 151803 <small>NEW</small> | PH.3 | 80 | 31 | 10 |

56pc 3/8" Combination set

| 3571 | | | |
|----------------|--|----------------|-------|
| Part no. | Socket | 3/17.0/18.0/1' | 5667g |
| 539 06...24 | Content:3/8"DR. 14-12pt. Flank socket 6; 7; 8; 9; 10; 11; 12; 13; 14; 15; 17; 19; 22; 24 mm | | |
| 53546 08...14 | 9-6pt. Flank deep socket 8; 10; 12; 13; 14 mm (46mmL) | | |
| 53563 17...24 | 17; 19; 22; 24 mm (63mmL) | | |
| 334080 04...12 | 7-Hex socket bit 4; 5; 6; 7; 8; 10; 12 mm (80mmL) | | |
| 33650 10...50 | 14-Socket bit (50mmL) Star T10; T20; T25; T27; T30; T40; T45; T50 | | |
| 33350 04...08 | Slotted 0.8x4; 1.0x5.5; 1.2x8 mm | | |
| 33150 1...3 | Phillips PH.1; PH.2; PH.3 | | |
| 8073 16...20.6 | 3-Spark plug socket 16; 18; 20.6 mm | | |
| 80232 | 1-Ratchet handle | | |
| 8043 075...225 | 2-Extension bar 3"; 9" | | |
| 80531 | 1-Universal joint | | |
| 764-4 | 4-Hey key 1.27; 1.5; 2; 2.5 | | |
| 80633 | 1-Adaptor for extension 3/8"(F)x3/8"(M) | | |

56pc 3/8" Combination set

| 3571-72 | | | |
|----------------|--|----------------|-------|
| Part no. | Socket | 3/17.0/18.0/1' | 5667g |
| 539 06...24 | Content:3/8"DR. 14-12pt. Flank socket 6; 7; 8; 9; 10; 11; 12; 13; 14; 15; 17; 19; 22; 24 mm | | |
| 53546 08...14 | 9-6pt. Flank deep socket 8; 10; 12; 13; 14 mm (46mmL) | | |
| 53563 17...24 | 17; 19; 22; 24 mm (63mmL) | | |
| 334080 04...12 | 7-Hex socket bit (80mmL) 4; 5; 6; 7; 8; 10; 12 mm | | |
| 33650 10...50 | 14-Socket bit (50mmL) Star T10; T20; T25; T27; T30; T40; T45; T50 | | |
| 33350 04...08 | Slotted 0.8x4; 1.0x5.5; 1.2x8 mm | | |
| 33150 1...3 | Phillips PH.1; PH.2; PH.3 | | |
| 8073 16...20.6 | 3-Spark plug socket 16; 18; 20.6 mm | | |
| 80239 | 1-72 teeth ratchet handle | | |
| 8043 075...225 | 2-Extension bar 3"; 9" | | |
| 80531 | 1-Universal joint | | |
| 764-4 | 4-Hey key 1.27; 1.5; 2; 2.5 | | |
| 80633 | 1-Adaptor for extension 3/8"(F)x3/8"(M) | | |

61pc 3/8" Combination set

| 3611 | | | |
|----------------|--|----------------|-------|
| Part no. | Socket | 4/16.5/17.5/1' | 4500g |
| 537 06...24 | Content:3/8"DR. 18-Surface drive socket 6; 7; 8; 9; 10; 11; 12; 13; 14; 15; 16; 17; 18; 19; 20; 21; 22; 24 mm | | |
| 53763 08..19 | 9-Surface drive deep socket (63mmL) 8; 10; 11; 12; 13; 14; 15; 17; 19 mm | | |
| 334050 03...10 | 26-Socket bit (50mmL) Hex 3; 4; 5; 6; 7; 8; 10 mm | | |
| 33650 10...55 | Star T10; T15; T20; T25; T27; T30; T40; T45; T50; T55 | | |
| 33350 055...08 | Slotted 5.5; 6.5; 8 | | |
| 33150 1...3 | Phillips PH.1; PH.2; PH.3 | | |
| 33250 1...3 | Poizdriv PZ.1; PZ.2; PZ.3 | | |
| 80232 | 1-Ratchet handle | | |
| 8073 16...20.6 | 2-Spark plug socket 16; 20.6 mm | | |
| 8043 075...250 | 3-Extension bar 3"; 6"; 10" | | |
| 80531 | 1-Universal joint | | |
| 80643 | 1-Adaptor for extension 1/2"DR.x3/8"(M) | | |

| 3611-5 | | | |
|--------------|---|----------------|-------|
| Part no. | Socket | 4/16.8/17.8/1' | 4500g |
| 535 06...24 | Content:3/8"DR. 18-6pt. Flank socket 6; 7; 8; 9; 10; 11; 12; 13; 14; 15; 16; 17; 18; 19; 20; 21; 22; 24 mm | | |
| 53563 08..19 | 9-6pt. Flank socket 8; 10; 11; 12; 13; 14; 15; 17; 19 mm | | |

5/16" Pozidriv bit

| 152 | | | | |
|---------------------------|------|----|----|--------|
| Part no. | size | mm | g | pc/box |
| 152301 | PZ.1 | 30 | 10 | 10 |
| 152302 | PZ.2 | 30 | 10 | 10 |
| 152303 | PZ.3 | 30 | 10 | 10 |
| 152304 | PZ.4 | 30 | 10 | 10 |
| 152321 | PZ.1 | 32 | 10 | 10 |
| 152322 | PZ.2 | 32 | 10 | 10 |
| 152323 | PZ.3 | 32 | 12 | 10 |
| 152362 <small>NEW</small> | PZ.2 | 36 | 13 | 10 |
| 152363 <small>NEW</small> | PZ.3 | 36 | 13 | 10 |
| 152384 | PZ.4 | 38 | 14 | 10 |
| 152802 <small>NEW</small> | PZ.2 | 80 | 30 | 10 |
| 152803 <small>NEW</small> | PZ.3 | 80 | 31 | 10 |





5/16" Slotted bit

| 153 | | <i>l</i> | | |
|--------------------|---------|----------|----|--------|
| Part no. | size | mm | g | pc/box |
| 15330055 | 0.8x5.5 | 30 | 9 | 10 |
| 1533007 | 1.2x7 | 30 | 10 | 10 |
| 1533008 | 1.2x8 | 30 | 12 | 10 |
| 1533010 | 1.6x10 | 30 | 14 | 10 |
| 1533012 | 2.0x12 | 30 | 14 | 10 |
| 1533609 NEW | 1.6x9 | 36 | 16 | 10 |
| 1533610 NEW | 1.6x10 | 36 | 16 | 10 |
| 1533611 NEW | 1.8x11 | 36 | 16 | 10 |
| 1533612 NEW | 2.0x12 | 36 | 16 | 10 |
| 1538009 NEW | 1.6x9 | 80 | 32 | 10 |
| 1538011 NEW | 1.8x11 | 80 | 33 | 10 |



5/16" Hex bit

| 154 | | <i>l</i> | | |
|--------------------|-------|----------|----|--------|
| Part no. | size | mm | g | pc/box |
| 1543003 | 3 | 30 | 8 | 10 |
| 1543004 | 4 | 30 | 9 | 10 |
| 1543005 | 5 | 30 | 10 | 10 |
| 1543006 | 6 | 30 | 11 | 10 |
| 1543007 | 7 | 30 | 12 | 10 |
| 1543008 | 8 | 30 | 12 | 10 |
| 1543010 | 10 | 30 | 16 | 10 |
| 1543012 | 12 | 30 | 21 | 10 |
| 1543014 | 14 | 30 | 25 | 10 |
| 154301.8 | 1/8" | 30 | 12 | 10 |
| 154305.32 | 5/32" | 30 | 12 | 10 |
| 154303.16 | 3/16" | 30 | 12 | 10 |
| 154301.4 | 1/4" | 30 | 12 | 10 |
| 154309.32 | 9/32" | 30 | 13 | 10 |
| 154305.16 | 5/16" | 30 | 13 | 10 |
| 154303.8 | 3/8" | 30 | 16 | 10 |
| 154307.16 | 7/16" | 30 | 18 | 10 |
| 154301.2 | 1/2" | 30 | 22 | 10 |
| 154309.16 | 9/16" | 30 | 26 | 10 |
| 1543606 NEW | 6 | 36 | 13 | 10 |
| 1543608 NEW | 8 | 36 | 14 | 10 |
| 1543610 NEW | 10 | 36 | 16 | 10 |
| 1547004 NEW | 4 | 70 | 50 | 10 |
| 1547005 NEW | 5 | 70 | 50 | 10 |
| 1547006 NEW | 6 | 70 | 50 | 10 |
| 1547007 NEW | 7 | 70 | 52 | 10 |
| 1547008 NEW | 8 | 70 | 53 | 10 |
| 1547010 NEW | 10 | 70 | 55 | 10 |
| 1547012 NEW | 12 | 70 | 55 | 10 |
| 1547014 NEW | 14 | 70 | 60 | 10 |



5/16" Star bit

| 156 | | <i>l</i> | | |
|----------|------|----------|----|--------|
| Part no. | size | mm | g | pc/box |
| 1563010 | T10 | 30 | 9 | 10 |
| 1563015 | T15 | 30 | 9 | 10 |
| 1563020 | T20 | 30 | 9 | 10 |
| 1563025 | T25 | 30 | 9 | 10 |
| 1563027 | T27 | 30 | 9 | 10 |
| 1563030 | T30 | 30 | 10 | 10 |
| 1563040 | T40 | 30 | 10 | 10 |
| 1563045 | T45 | 30 | 11 | 10 |
| 1563050 | T50 | 30 | 12 | 10 |
| 1563055 | T55 | 30 | 14 | 10 |
| 1563060 | T60 | 30 | 24 | 10 |
| 1563520 | T20 | 35 | 12 | 10 |
| 1563525 | T25 | 35 | 12 | 10 |
| 1563527 | T27 | 35 | 12 | 10 |
| 1563530 | T30 | 35 | 12 | 10 |
| 1563540 | T40 | 35 | 12 | 10 |
| 1563545 | T45 | 35 | 12 | 10 |
| 1563550 | T50 | 35 | 14 | 10 |
| 1563555 | T55 | 35 | 16 | 10 |
| 1567010 | T10 | 70 | 30 | 10 |
| 1567015 | T15 | 70 | 30 | 10 |
| 1567020 | T20 | 70 | 30 | 10 |
| 1567025 | T25 | 70 | 30 | 10 |
| 1567027 | T27 | 70 | 30 | 10 |
| 1567030 | T30 | 70 | 30 | 10 |
| 1567040 | T40 | 70 | 30 | 10 |
| 1567045 | T45 | 70 | 30 | 10 |
| 1567050 | T50 | 70 | 30 | 10 |
| 1567055 | T55 | 70 | 40 | 10 |
| 1567060 | T60 | 70 | 56 | 10 |



5/16" Star tamperproof bit

| 157 | | <i>l</i> | | |
|----------|-------|----------|----|--------|
| Part no. | size | mm | g | pc/box |
| 1573010 | T-10H | 30 | 10 | 10 |
| 1573015 | T-15H | 30 | 10 | 10 |
| 1573020 | T-20H | 30 | 10 | 10 |
| 1573025 | T-25H | 30 | 10 | 10 |
| 1573027 | T-27H | 30 | 10 | 10 |
| 1573030 | T-30H | 30 | 10 | 10 |
| 1573040 | T-40H | 30 | 10 | 10 |
| 1573045 | T-45H | 30 | 10 | 10 |
| 1573050 | T-50H | 30 | 12 | 10 |
| 1573055 | T-55H | 30 | 14 | 10 |
| 1573060 | T-60H | 30 | 24 | 10 |
| 1577010 | T-10H | 70 | 30 | 10 |
| 1577015 | T-15H | 70 | 30 | 10 |
| 1577020 | T-20H | 70 | 30 | 10 |
| 1577025 | T-25H | 70 | 30 | 10 |
| 1577027 | T-27H | 70 | 30 | 10 |
| 1577030 | T-30H | 70 | 30 | 10 |
| 1577040 | T-40H | 70 | 30 | 10 |
| 1577045 | T-45H | 70 | 30 | 10 |
| 1577050 | T-50H | 70 | 30 | 10 |
| 1577055 | T-55H | 70 | 40 | 10 |
| 1577060 | T-60H | 70 | 56 | 10 |



3/8" Phillips socket bit

| 331 | | | | |
|------------|------|----|----|--------|
| Part no. | size | mm | g | pc/box |
| 331501 | PH.1 | 50 | 42 | 20 |
| 331502 | PH.2 | 50 | 42 | 20 |
| 331503 | PH.3 | 50 | 42 | 20 |
| 331504 | PH.4 | 50 | 46 | 20 |



3/8" Slotted socket bit

| 333 | | | | |
|------------|---------|----|----|--------|
| Part no. | size | mm | g | pc/box |
| 3335004 | 1.8x4 | 50 | 50 | 20 |
| 3335005 | 1.0x5 | 50 | 50 | 20 |
| 33350055 | 1.0x5.5 | 50 | 50 | 20 |
| 3335006 | 1.0x6 | 50 | 50 | 20 |
| 3335007 | 1.2x7 | 50 | 50 | 20 |
| 3335008 | 1.2x8 | 50 | 50 | 20 |



3/8" Pozidriv socket bit

| 332 | | | | |
|------------|------|----|----|--------|
| Part no. | size | mm | g | pc/box |
| 332501 | PZ.1 | 50 | 50 | 20 |
| 332502 | PZ.2 | 50 | 50 | 20 |
| 332503 | PZ.3 | 50 | 52 | 20 |
| 332504 | PZ.4 | 50 | 52 | 20 |

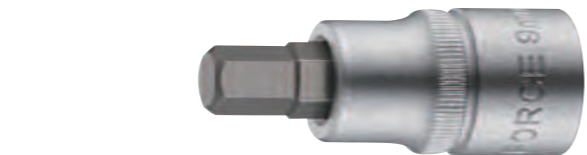

3/8" Hex socket bit

| 334 | | | | |
|------------|------|----|----|--------|
| Part no. | size | mm | g | pc/box |
| 33405003 | 3 | 50 | 42 | 20 |
| 33405004 | 4 | 50 | 42 | 20 |
| 33405005 | 5 | 50 | 43 | 20 |
| 334050055 | 5.5 | 50 | 43 | 20 |
| 33405006 | 6 | 50 | 43 | 20 |
| 33405007 | 7 | 50 | 47 | 20 |
| 33405008 | 8 | 50 | 47 | 20 |
| 33405009 | 9 | 50 | 52 | 20 |
| 33405010 | 10 | 50 | 57 | 20 |
| 33405012 | 12 | 50 | 66 | 20 |



3/8" Hex ball point socket bit

| 335 | | | | |
|------------|------|-----|----|--------|
| Part no. | size | mm | g | pc/box |
| 33506203 | 3 | 62 | 48 | 10 |
| 33506204 | 4 | 62 | 48 | 10 |
| 33506205 | 5 | 62 | 54 | 10 |
| 33506206 | 6 | 62 | 54 | 10 |
| 33506207 | 7 | 62 | 58 | 10 |
| 33506208 | 8 | 62 | 58 | 10 |
| 33506210 | 10 | 62 | 68 | 10 |
| 33510003 | 3 | 100 | 56 | 10 |
| 33510004 | 4 | 100 | 56 | 10 |
| 33510005 | 5 | 100 | 62 | 10 |
| 33510006 | 6 | 100 | 62 | 10 |
| 33510007 | 7 | 100 | 66 | 10 |
| 33510008 | 8 | 100 | 74 | 10 |
| 33510010 | 10 | 100 | 94 | 10 |



3/8" Star socket bit

| 336 | | | | |
|------------------------|------|----|----|--------|
| Part no. | size | mm | g | pc/box |
| 3365008 | T8 | 50 | 50 | 20 |
| 3365009 ^{NEW} | T9 | 50 | 50 | 20 |
| 3365010 | T10 | 50 | 50 | 20 |
| 3365015 | T15 | 50 | 50 | 20 |
| 3365020 | T20 | 50 | 50 | 20 |
| 3365025 | T25 | 50 | 50 | 20 |
| 3365027 | T27 | 50 | 50 | 20 |
| 3365030 | T30 | 50 | 50 | 20 |
| 3365040 | T40 | 50 | 50 | 20 |
| 3365045 | T45 | 50 | 52 | 20 |
| 3365050 | T50 | 50 | 52 | 20 |
| 3365055 | T55 | 50 | 62 | 20 |
| 3365060 | T60 | 50 | 72 | 20 |

| 334 | | | | |
|------------|-------|-----|-----|--------|
| Part no. | size | mm | g | pc/box |
| 3340501.8 | 1/8" | 50 | 42 | 20 |
| 3340505.32 | 5/32" | 50 | 42 | 20 |
| 3340503.16 | 3/16" | 50 | 43 | 20 |
| 3340507.32 | 7/32" | 50 | 43 | 20 |
| 3340501.4 | 1/4" | 50 | 45 | 20 |
| 3340505.16 | 5/16" | 50 | 47 | 20 |
| 3340503.8 | 3/8" | 50 | 57 | 20 |
| 3340507.16 | 7/16" | 50 | 62 | 20 |
| 3340501.2 | 1/2" | 50 | 66 | 20 |
| 33405504 | 4 | 55 | 48 | 10 |
| 33406005 | 5 | 60 | 50 | 10 |
| 33406506 | 6 | 65 | 52 | 10 |
| 33407007 | 7 | 70 | 62 | 10 |
| 33407508 | 8 | 75 | 64 | 10 |
| 33408510 | 10 | 85 | 86 | 10 |
| 33409012 | 12 | 90 | 108 | 10 |
| 3340555.32 | 5/32" | 55 | 48 | 10 |
| 3340603.16 | 3/16" | 60 | 50 | 10 |
| 3340657.32 | 7/32" | 65 | 52 | 10 |
| 3340701.4 | 1/4" | 70 | 62 | 10 |
| 3340805.16 | 5/16" | 80 | 80 | 10 |
| 3340803.8 | 3/8" | 80 | 86 | 10 |
| 33408004 | 4 | 80 | 56 | 10 |
| 33408005 | 5 | 80 | 58 | 10 |
| 33408006 | 6 | 80 | 58 | 10 |
| 33408007 | 7 | 80 | 66 | 10 |
| 33408008 | 8 | 80 | 66 | 10 |
| 33408009 | 9 | 80 | 86 | 10 |
| 33408010 | 10 | 80 | 80 | 10 |
| 33408012 | 12 | 80 | 104 | 10 |
| 33410008 | 8 | 100 | 75 | 10 |
| 33413010 | 10 | 130 | 120 | 10 |
| 33418005 | 5 | 180 | 75 | 10 |
| 33422006 | 6 | 220 | 93 | 10 |



3/8" Star tamperproof socket bit

| 337 | | | | |
|--------------------|-------|----|----|--------|
| Part no. | size | mm | g | pc/box |
| 3375008 | T-8H | 50 | 42 | 20 |
| 3375010 | T-10H | 50 | 42 | 20 |
| 3375015 | T-15H | 50 | 42 | 20 |
| 3375020 | T-20H | 50 | 42 | 20 |
| 3375025 | T-25H | 50 | 42 | 20 |
| 3375027 | T-27H | 50 | 42 | 20 |
| 3375030 | T-30H | 50 | 42 | 20 |
| 3375035 NEW | T-35H | 50 | 42 | 20 |
| 3375040 | T-40H | 50 | 42 | 20 |
| 3375045 | T-45H | 50 | 46 | 20 |
| 3375050 | T-50H | 50 | 47 | 20 |
| 3375055 | T-55H | 50 | 55 | 20 |
| 3375060 | T-60H | 50 | 60 | 20 |

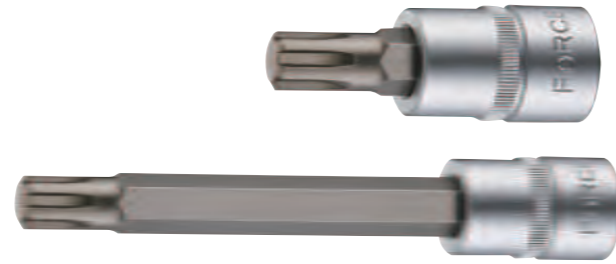

3/8" Ribe socket bit

| 339 | | | | |
|------------|------|-----|-----|--------|
| Part no. | size | mm | g | pc/box |
| 33905007 | M7 | 50 | 50 | 20 |
| 33905010 | M10 | 50 | 55 | 20 |
| 33909005 | M5 | 90 | 58 | 10 |
| 33909006 | M6 | 90 | 60 | 10 |
| 33909007 | M7 | 90 | 63 | 10 |
| 33909008 | M8 | 90 | 64 | 10 |
| 33909009 | M9 | 90 | 81 | 10 |
| 33909010 | M10 | 90 | 83 | 10 |
| 33920007 | M7 | 200 | 102 | 10 |
| 33924008 | M8 | 240 | 129 | 10 |



3/8" DR. 6pt. Flank socket

| 535 | | | | |
|---------------------|--------|----|----|--------|
| Part no. | size | mm | g | pc/box |
| 53506 | 6 | 28 | 22 | 20 |
| 53507 | 7 | 28 | 23 | 20 |
| 53508 | 8 | 28 | 24 | 20 |
| 53509 | 9 | 28 | 24 | 20 |
| 53510 | 10 | 28 | 24 | 20 |
| 53511 | 11 | 28 | 25 | 20 |
| 53512 | 12 | 28 | 25 | 20 |
| 53513 | 13 | 28 | 28 | 20 |
| 53514 | 14 | 30 | 36 | 20 |
| 53515 | 15 | 30 | 44 | 20 |
| 53516 | 16 | 30 | 44 | 20 |
| 53517 | 17 | 30 | 47 | 20 |
| 53518 | 18 | 30 | 47 | 20 |
| 53519 | 19 | 30 | 55 | 20 |
| 53520 | 20 | 30 | 66 | 20 |
| 53521 | 21 | 30 | 66 | 20 |
| 53522 | 22 | 32 | 74 | 20 |
| 53523 NEW | 23 | 32 | 74 | 20 |
| 53524 | 24 | 32 | 77 | 20 |
| 5351.4 | 1/4" | 28 | 23 | 20 |
| 5355.16 | 5/16" | 28 | 24 | 20 |
| 5353.8 | 3/8" | 28 | 25 | 20 |
| 5357.16 | 7/16" | 28 | 28 | 20 |
| 5351.2 | 1/2" | 28 | 32 | 20 |
| 5359.16 | 9/16" | 30 | 38 | 20 |
| 53519.32 | 19/32" | 30 | 44 | 20 |
| 5355.8 | 5/8" | 30 | 44 | 20 |
| 53511.16 | 11/16" | 30 | 47 | 20 |
| 5353.4 | 3/4" | 30 | 55 | 20 |
| 53525.32 | 25/32" | 30 | 71 | 20 |
| 53513.16 | 13/16" | 30 | 71 | 20 |
| 5357.8 | 7/8" | 32 | 72 | 20 |
| 53515.16 NEW | 15/16" | 32 | 72 | 20 |



3/8" DR. 6pt. Flank deep socket

| 53546 | | | | |
|--------------|------|----|----|--------|
| Part no. | size | mm | g | pc/box |
| 5354608 | 8 | 46 | 29 | 20 |
| 5354610 | 10 | 46 | 34 | 20 |
| 5354612 | 12 | 46 | 38 | 20 |
| 5354613 | 13 | 46 | 43 | 20 |
| 5354614 | 14 | 46 | 54 | 20 |

3/8" DR. 6pt. Flank deep socket

| 53563 | | | | |
|-----------------------|--------|----|-----|--------|
| Part no. | size | mm | g | pc/box |
| 5356306 | 6 | 63 | 34 | 20 |
| 5356307 | 7 | 63 | 39 | 20 |
| 5356308 | 8 | 63 | 33 | 20 |
| 5356309 | 9 | 63 | 42 | 20 |
| 5356310 | 10 | 63 | 46 | 20 |
| 5356311 | 11 | 63 | 50 | 20 |
| 5356312 | 12 | 63 | 51 | 20 |
| 5356313 | 13 | 63 | 60 | 20 |
| 5356314 | 14 | 63 | 74 | 20 |
| 5356315 | 15 | 63 | 90 | 20 |
| 5356316 | 16 | 63 | 86 | 20 |
| 5356317 | 17 | 63 | 102 | 10 |
| 5356318 | 18 | 63 | 94 | 10 |
| 5356319 | 19 | 63 | 125 | 10 |
| 5356320 | 20 | 63 | 141 | 10 |
| 5356321 | 21 | 63 | 129 | 10 |
| 5356322 | 22 | 63 | 150 | 10 |
| 5356323 NEW | 23 | 63 | 151 | 10 |
| 5356324 NEW | 24 | 63 | 152 | 10 |
| 535635.16 | 5/16" | 63 | 33 | 20 |
| 535633.8 | 3/8" | 63 | 46 | 20 |
| 535637.16 | 7/16" | 63 | 50 | 20 |
| 535631.2 | 1/2" | 63 | 51 | 20 |
| 535639.16 | 9/16" | 63 | 74 | 20 |
| 535635.8 | 5/8" | 63 | 86 | 20 |
| 5356311.16 | 11/16" | 63 | 102 | 10 |
| 535633.4 | 3/4" | 63 | 125 | 10 |
| 5356313.16 NEW | 13/16" | 63 | 129 | 10 |
| 535637.8 NEW | 7/8" | 63 | 150 | 10 |

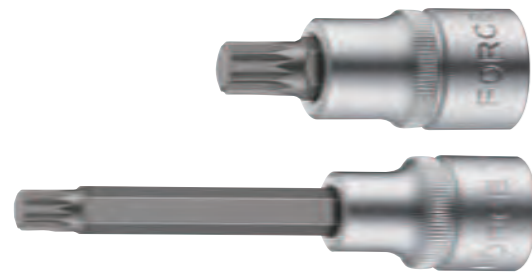

3/8" Spline socket bit

| 338 | | | | |
|------------|------|----|----|--------|
| Part no. | size | mm | g | pc/box |
| 3385005 | M5 | 50 | 50 | 20 |
| 3385006 | M6 | 50 | 50 | 20 |
| 3385008 | M8 | 50 | 52 | 20 |
| 3385009 | M9 | 50 | 54 | 20 |
| 3385010 | M10 | 50 | 54 | 20 |
| 3385012 | M12 | 50 | 56 | 20 |
| 3388808 | M8 | 88 | 68 | 10 |
| 3388909 | M9 | 89 | 86 | 10 |
| 3388910 | M10 | 89 | 86 | 10 |



3/8" Five-sided star tamperproof socket bit

| 33F | | | | |
|------------|------|----|----|--------|
| Part no. | size | mm | g | pc/box |
| 33F5045 | TS45 | 50 | 52 | 20 |
| 33F5050 | TS50 | 50 | 52 | 20 |



3/8" DR. Star socket

| 536 | | | | |
|------------|------|----|----|--------|
| Part no. | size | mm | g | pc/box |
| 53604 | E4 | 28 | 22 | 20 |
| 53605 | E5 | 28 | 23 | 20 |
| 53606 | E6 | 28 | 23 | 20 |
| 53607 | E7 | 28 | 23 | 20 |
| 53608 | E8 | 28 | 23 | 20 |
| 53610 | E10 | 28 | 24 | 20 |
| 53611 | E11 | 28 | 25 | 20 |
| 53612 | E12 | 28 | 26 | 20 |
| 53614 | E14 | 28 | 27 | 20 |
| 53616 | E16 | 28 | 30 | 20 |
| 53618 | E18 | 28 | 36 | 20 |
| 53620 | E20 | 28 | 46 | 20 |



3/8" DR. Surface drive socket

| 537 | | | | |
|------------|--------|----|----|--------|
| Part no. | size | mm | g | pc/box |
| 53706 | 6 | 28 | 22 | 20 |
| 53707 | 7 | 28 | 23 | 20 |
| 53708 | 8 | 28 | 24 | 20 |
| 53709 | 9 | 28 | 24 | 20 |
| 53710 | 10 | 28 | 24 | 20 |
| 53711 | 11 | 28 | 25 | 20 |
| 53712 | 12 | 28 | 25 | 20 |
| 53713 | 13 | 28 | 28 | 20 |
| 53714 | 14 | 30 | 36 | 20 |
| 53715 | 15 | 30 | 44 | 20 |
| 53716 | 16 | 30 | 44 | 20 |
| 53717 | 17 | 30 | 47 | 20 |
| 53718 | 18 | 30 | 47 | 20 |
| 53719 | 19 | 30 | 55 | 20 |
| 53720 | 20 | 30 | 66 | 20 |
| 53721 | 21 | 30 | 66 | 20 |
| 53722 | 22 | 32 | 74 | 20 |
| 53724 | 24 | 32 | 77 | 20 |
| 5371.4 | 1/4" | 28 | 23 | 20 |
| 5375.16 | 5/16" | 28 | 24 | 20 |
| 5373.8 | 3/8" | 28 | 25 | 20 |
| 5377.16 | 7/16" | 28 | 28 | 20 |
| 5371.2 | 1/2" | 28 | 32 | 20 |
| 5379.16 | 9/16" | 30 | 38 | 20 |
| 53719.32 | 19/32" | 30 | 44 | 20 |
| 5375.8 | 5/8" | 30 | 44 | 20 |
| 53711.16 | 11/16" | 30 | 47 | 20 |
| 5373.4 | 3/4" | 30 | 55 | 20 |
| 53725.32 | 25/32" | 30 | 71 | 20 |
| 53713.16 | 13/16" | 30 | 71 | 20 |
| 5377.8 | 7/8" | 32 | 72 | 20 |



3/8" DR. Star deep socket

| 536 | | | | |
|------------|------|----|----|--------|
| Part no. | size | mm | g | pc/box |
| 5365504 | E4 | 55 | 26 | 20 |
| 5365505 | E5 | 55 | 29 | 20 |
| 5365506 | E6 | 55 | 30 | 20 |
| 5365507 | E7 | 55 | 34 | 20 |
| 5366308 | E8 | 63 | 40 | 20 |
| 5366310 | E10 | 63 | 45 | 20 |
| 5366311 | E11 | 63 | 53 | 20 |
| 5366312 | E12 | 63 | 57 | 20 |
| 5366314 | E14 | 63 | 66 | 20 |
| 5366316 | E16 | 63 | 78 | 20 |
| 5366318 | E18 | 63 | 97 | 20 |



3/8" DR. Surface drive deep socket

| 53763 | | | | |
|----------------------------|------|----|-----|--------|
| Part no. | size | mm | g | pc/box |
| 5376306 <small>NEW</small> | 6 | 63 | 33 | 20 |
| 5376307 <small>NEW</small> | 7 | 63 | 36 | 20 |
| 5376308 | 8 | 63 | 40 | 20 |
| 5376310 | 10 | 63 | 45 | 20 |
| 5376311 | 11 | 63 | 53 | 20 |
| 5376312 | 12 | 63 | 57 | 20 |
| 5376313 | 13 | 63 | 61 | 20 |
| 5376314 | 14 | 63 | 66 | 20 |
| 5376315 | 15 | 63 | 70 | 20 |
| 5376316 <small>NEW</small> | 16 | 63 | 79 | 20 |
| 5376317 | 17 | 63 | 78 | 10 |
| 5376318 <small>NEW</small> | 18 | 63 | 94 | 10 |
| 5376319 | 19 | 63 | 97 | 10 |
| 5376320 <small>NEW</small> | 20 | 63 | 142 | 10 |
| 5376321 <small>NEW</small> | 21 | 63 | 132 | 10 |
| 5376322 <small>NEW</small> | 22 | 63 | 149 | 10 |



3/8" DR. 12pt. Flank socket

| 539 | | | | |
|--------------------------|------|----|----|--------|
| Part no. | size | mm | g | pc/box |
| 53906 | 6 | 28 | 23 | 20 |
| 53907 | 7 | 28 | 24 | 20 |
| 53908 | 8 | 28 | 24 | 20 |
| 53909 | 9 | 28 | 24 | 20 |
| 53910 | 10 | 28 | 24 | 20 |
| 53911 | 11 | 28 | 24 | 20 |
| 53912 | 12 | 28 | 24 | 20 |
| 53913 | 13 | 28 | 27 | 20 |
| 53914 | 14 | 30 | 36 | 20 |
| 53915 | 15 | 30 | 44 | 20 |
| 53916 | 16 | 30 | 44 | 20 |
| 53917 | 17 | 30 | 47 | 20 |
| 53918 | 18 | 30 | 47 | 20 |
| 53919 | 19 | 30 | 55 | 20 |
| 53920 | 20 | 30 | 66 | 20 |
| 53921 | 21 | 30 | 66 | 20 |
| 53922 | 22 | 32 | 74 | 20 |
| 53923 <small>NEW</small> | 23 | 32 | 72 | 20 |
| 53924 | 24 | 32 | 77 | 20 |

| 539 | | | | |
|------------|--------|----|----|--------|
| Part no. | size | mm | g | pc/box |
| 5391.4 | 1/4" | 28 | 23 | 20 |
| 5395.16 | 5/16" | 28 | 24 | 20 |
| 5393.8 | 3/8" | 28 | 25 | 20 |
| 5397.16 | 7/16" | 28 | 28 | 20 |
| 5391.2 | 1/2" | 28 | 32 | 20 |
| 5399.16 | 9/16" | 30 | 38 | 20 |
| 53919.32 | 19/32" | 30 | 44 | 20 |
| 5395.8 | 5/8" | 30 | 44 | 20 |
| 53911.16 | 11/16" | 30 | 47 | 20 |
| 5393.4 | 3/4" | 30 | 55 | 20 |
| 53925.32 | 25/32" | 30 | 71 | 20 |
| 53913.16 | 13/16" | 30 | 71 | 20 |
| 5397.8 | 7/8" | 32 | 72 | 20 |



3/8" DR. 12pt. Flank deep socket

| 53963 | | | | |
|-------------------------------|--------|----|-----|--------|
| Part no. | size | mm | g | pc/box |
| 5396306 | 6 | 63 | 50 | 20 |
| 5396307 | 7 | 63 | 50 | 20 |
| 5396308 | 8 | 63 | 54 | 20 |
| 5396309 | 9 | 63 | 54 | 20 |
| 5396310 | 10 | 63 | 66 | 20 |
| 5396311 | 11 | 63 | 66 | 20 |
| 5396312 | 12 | 63 | 66 | 20 |
| 5396313 | 13 | 63 | 82 | 20 |
| 5396314 | 14 | 63 | 82 | 20 |
| 5396315 | 15 | 63 | 88 | 20 |
| 5396316 | 16 | 63 | 102 | 20 |
| 5396317 | 17 | 63 | 120 | 10 |
| 5396318 | 18 | 63 | 130 | 10 |
| 5396319 | 19 | 63 | 138 | 10 |
| 5396320 | 20 | 63 | 176 | 10 |
| 5396321 | 21 | 63 | 194 | 10 |
| 5396322 | 22 | 63 | 220 | 10 |
| 539635.16 <small>NEW</small> | 5/16" | 63 | 54 | 20 |
| 539633.8 <small>NEW</small> | 3/8" | 63 | 54 | 20 |
| 539637.16 <small>NEW</small> | 7/16" | 63 | 66 | 20 |
| 539631.2 <small>NEW</small> | 1/2" | 63 | 66 | 20 |
| 539639.16 <small>NEW</small> | 9/16" | 63 | 82 | 20 |
| 539635.8 <small>NEW</small> | 5/8" | 63 | 102 | 20 |
| 5396311.16 <small>NEW</small> | 11/16" | 63 | 120 | 10 |
| 539633.4 <small>NEW</small> | 3/4" | 63 | 138 | 10 |
| 5396313.16 <small>NEW</small> | 13/16" | 63 | 194 | 10 |
| 539637.8 <small>NEW</small> | 7/8" | 63 | 197 | 10 |



3/8"DR. Spline socket

| 53Q | | | | | | | | | |
|----------|------|--------|---------|--------|--------|-----|----|-----|--------|
| Part no. | size | 6point | 12point | SAE | E-Torx | XZN | mm | g | pc/box |
| 53Q06 | 6 | . | . | | E8 | 6 | 25 | 24 | 20 |
| 53Q07 | 7 | . | . | 9/32" | | 7 | 25 | 24 | 20 |
| 53Q08 | 8 | . | . | 5/16" | E10 | 8 | 25 | 24 | 20 |
| 53Q09 | 9 | . | . | 11/32" | E11 | 9 | 25 | 24 | 20 |
| 53Q10 | 10 | . | . | 3/8" | E12 | 10 | 25 | 24 | 20 |
| 53Q11 | 11 | . | . | 7/16" | E14 | 11 | 25 | 24 | 20 |
| 53Q12 | 12 | . | . | 15/32" | | 12 | 25 | 24 | 20 |
| 53Q13 | 13 | . | . | 1/2" | E16 | | 25 | 32 | 20 |
| 53Q14 | 14 | . | . | 9/16" | E18 | 14 | 25 | 44 | 20 |
| 53Q15 | 15 | . | . | 19/32" | | | 25 | 48 | 20 |
| 53Q16 | 16 | . | . | 5/8" | E20 | 16 | 25 | 60 | 20 |
| 53Q17 | 17 | . | . | | | | 25 | 74 | 20 |
| 53Q18 | 18 | . | . | | E22 | 18 | 25 | 75 | 20 |
| 53Q19 | 19 | . | . | 3/4" | E24 | | 25 | 90 | 20 |
| 53Q20 | 20 | . | . | 25/32" | | 20 | 25 | 92 | 20 |
| 53Q21 | 21 | . | . | 13/16" | | | 25 | 95 | 20 |
| 53Q22 | 22 | . | . | 7/8" | | 22 | 25 | 100 | 20 |
| 53Q24 | 24 | . | . | 15/16" | | 24 | 25 | 105 | 20 |



3/8"DR. Spline deep socket

| 53Q63 | | | | | | | | | |
|----------|------|--------|---------|--------|--------|-----|----|-----|--------|
| Part no. | size | 6point | 12point | SAE | E-Torx | XZN | mm | g | pc/box |
| 53Q6306 | 6 | . | . | | E8 | 6 | 63 | 50 | 20 |
| 53Q6307 | 7 | . | . | 9/32" | | 7 | 63 | 50 | 20 |
| 53Q6308 | 8 | . | . | 5/16" | E10 | 8 | 63 | 54 | 20 |
| 53Q6309 | 9 | . | . | 11/32" | E11 | 9 | 63 | 54 | 20 |
| 53Q6310 | 10 | . | . | 3/8" | E12 | 10 | 63 | 66 | 20 |
| 53Q6311 | 11 | . | . | 7/16" | E14 | 11 | 63 | 66 | 20 |
| 53Q6312 | 12 | . | . | 15/32" | | 12 | 63 | 66 | 20 |
| 53Q6313 | 13 | . | . | 1/2" | E16 | | 63 | 82 | 20 |
| 53Q6314 | 14 | . | . | 9/16" | E18 | 14 | 63 | 86 | 20 |
| 53Q6315 | 15 | . | . | 19/32" | | | 63 | 88 | 20 |
| 53Q6316 | 16 | . | . | 5/8" | E20 | 16 | 63 | 105 | 20 |
| 53Q6317 | 17 | . | . | | | | 63 | 120 | 10 |
| 53Q6318 | 18 | . | . | | E22 | 18 | 63 | 130 | 10 |
| 53Q6319 | 19 | . | . | 3/4" | E24 | | 63 | 138 | 10 |
| 53Q6320 | 20 | . | . | 25/32" | | 20 | 63 | 176 | 10 |
| 53Q6321 | 21 | . | . | 13/16" | | | 63 | 194 | 10 |
| 53Q6322 | 22 | . | . | 7/8" | | 22 | 63 | 220 | 10 |



3/8"DR. Swivel handle

| 8013215 | | | |
|----------|----------|-----|--------|
| Part no. | mm | g | pc/box |
| 8013215 | 215-8.5" | 307 | 10 |

* Spare part available

NEW



3/8" Bent flex handle

| 8013200B | | | |
|----------|--------|-----|--------|
| Part no. | mm | g | pc/box |
| 8013200B | 200-8" | 307 | 10 |

* Spare part available



3/8"DR. Ratchet handle-24 teeth-Thin

| 80234 | | | |
|----------|-----|-----|--------|
| Part no. | mm | g | pc/box |
| 80234 | 175 | 306 | 1 |

* Spare part available



3/8"DR. Ratchet handle-36 teeth-RD

| 80235 | | | |
|----------|-----|-----|--------|
| Part no. | mm | g | pc/box |
| 80235 | 180 | 309 | 1 |

* Spare part available



3/8"DR. Ratchet handle-24 teeth

| 80232 | | | |
|----------|-----|-----|--------|
| Part no. | mm | g | pc/box |
| 80232 | 215 | 354 | 1 |

* Spare part available



3/8"DR. Ratchet handle-32 teeth

| 80236 | | | |
|----------|-----|-----|--------|
| Part no. | mm | g | pc/box |
| 80236 | 193 | 288 | 1 |

* Spare part available



3/8"DR. Ratchet handle-24 teeth-Thin

| 80233 | | | |
|----------|-----|-----|--------|
| Part no. | mm | g | pc/box |
| 80233 | 200 | 294 | 1 |

* Spare part available



3/8"DR. 72 teeth Ratchet handle

| 80239 | | | |
|----------|-----|-----|--------|
| Part no. | mm | g | pc/box |
| 80239 | 195 | 248 | 1 |

* Spare part available



3/8"DR. Ratchet handle-24 teeth

| Part no. | mm | g | pc/box |
|---------------|-----|-----|--------|
| 802311 | 195 | 374 | 1 |

* Spare part available



3/8"DR. Gearless ratchet handle

| Part no. | mm | g | pc/box |
|---------------|-----|-----|--------|
| 802321 | 180 | 278 | 1 |



3/8"DR. Swivel ratchet handle

| Part no. | mm | g | pc/box |
|---------------|-----|-----|--------|
| 802334 | 235 | 300 | 1 |



3/8"DR. Extension

| Part no. | mm | g | pc/box |
|--------------------|----------|-----|--------|
| 8043044 | 44-1.75" | 41 | 10 |
| 8043075 | 75-3" | 78 | 10 |
| 8043100 NEW | 100-4" | 88 | 10 |
| 8043125 NEW | 125-5" | 118 | 10 |
| 8043150 | 150-6" | 148 | 10 |
| 8043200 NEW | 200-8" | 187 | 10 |
| 8043225 | 225-9" | 220 | 10 |
| 8043250 | 250-10" | 242 | 10 |
| 8043300 | 300-12" | 291 | 10 |
| 8043450 NEW | 450-18" | 403 | 10 |



3/8"DR. Ratchet handle-30 teeth

| Part no. | mm | g | pc/box |
|---------------|-----|-----|--------|
| 802315 | 175 | 324 | 1 |

* Spare part available



3/8"DR. 72 teeth round ratchet handle

| Part no. | mm | g | pc/box |
|---------------|-----|-----|--------|
| 802322 | 210 | 300 | 1 |

* Spare part available



3/8"DR. Stubby bit ratchet

| Part no. | size | mm | g | pc/box |
|----------|---------------|-----|-----|--------|
| 802305S | for 5/16" bit | 120 | 252 | 1 |
| 802307S | for 10mm bit | 120 | 256 | 1 |

* Spare part available



3/8"DR. Extension-Thin

| Part no. | mm | g | pc/box |
|-----------------|---------|-----|--------|
| 8043...R | | | |
| 8043150R | 150-6" | 120 | 10 |
| 8043225R | 225-9" | 178 | 10 |
| 8043300R | 300-12" | 235 | 10 |



3/8"DR. Flexible ratchet handle

| Part no. | mm | g | pc/box |
|---------------|-----|-----|--------|
| 802318 | 260 | 460 | 1 |

* Spare part available



3/8"DR. 72 teeth flexible round ratchet handle

| Part no. | mm | g | pc/box |
|---------------|-----|-----|--------|
| 802323 | 225 | 404 | 1 |

* Spare part available

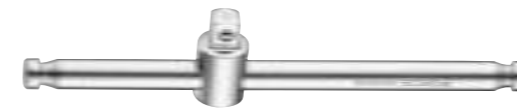

3/8"DR. Sliding T handle

| Part no. | mm | g | pc/box |
|----------------|-----|-----|--------|
| 8033165 | 165 | 182 | 10 |



3/8"DR. Wobble extension

| Part no. | mm | g | pc/box |
|---------------------|----------|-----|--------|
| 8043...W | | | |
| 8043044W | 44-1.75" | 45 | 10 |
| 8043075W | 75-3" | 67 | 10 |
| 8043150W | 150-6" | 120 | 10 |
| 8043225W NEW | 225-9" | 172 | 10 |
| 8043250W NEW | 250-10" | 220 | 10 |



3/8"DR. Stubby ratchet handle

| Part no. | mm | g | pc/box |
|---------------|-----|-----|--------|
| 802319 | 120 | 250 | 1 |

* Spare part available



3/8"DR. Quick-release 72 teeth round ratchet handle

| Part no. | mm | g | pc/box |
|---------------|-----|-----|--------|
| 802324 | 190 | 269 | 1 |

* Spare part available

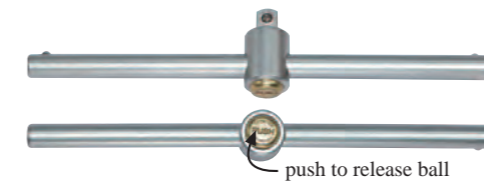

3/8"DR. Locking Sliding T handle

| Part no. | mm | g | pc/box |
|-----------------|--------|-----|--------|
| 8033200L | 200-8" | 184 | 10 |



3/8"DR. Universal joint

| Part no. | mm | g | pc/box |
|--------------|----|----|--------|
| 80531 | 46 | 61 | 10 |



3/8"DR. Universal socket

| Part no. | socket | mm | g | pc/box |
|------------|--------|----|----|--------|
| 8053510 | 10 | 42 | 64 | 10 |
| 8053511 | 11 | 42 | 66 | 10 |
| 8053512 | 12 | 42 | 67 | 10 |
| 8053513 | 13 | 42 | 67 | 10 |
| 8053514 | 14 | 42 | 70 | 10 |
| 8053515 | 15 | 42 | 77 | 10 |
| 8053516 | 16 | 42 | 78 | 10 |
| 8053517 | 17 | 42 | 82 | 10 |
| 8053518 | 18 | 42 | 92 | 10 |
| 8053519 | 19 | 42 | 92 | 10 |
| 805353.8 | 3/8" | 42 | 64 | 10 |
| 805357.16 | 7/16" | 42 | 66 | 10 |
| 805351.2 | 1/2" | 42 | 67 | 10 |
| 805359.16 | 9/16" | 42 | 67 | 10 |
| 805355.8 | 5/8" | 42 | 78 | 10 |
| 8053511.16 | 11/16" | 42 | 82 | 10 |
| 805353.4 | 3/4" | 42 | 92 | 10 |



3/8"DR. Star universal socket

| Part no. | socket | mm | g | pc/box |
|----------|--------|----|----|--------|
| 8053606 | E6 | 42 | 52 | 10 |
| 8053607 | E7 | 42 | 52 | 10 |
| 8053608 | E8 | 42 | 56 | 10 |
| 8053610 | E10 | 42 | 56 | 10 |
| 8053611 | E11 | 42 | 60 | 10 |
| 8053612 | E12 | 42 | 60 | 10 |
| 8053614 | E14 | 42 | 62 | 10 |
| 8053616 | E16 | 42 | 62 | 10 |



Adaptor for 3/8"DR. Extension

| Part no. | size | mm | g | pc/box |
|----------|-----------------|----|----|--------|
| 80633 | 3/8"(F)x3/8"(M) | 35 | 38 | 20 |
| 80643 | 1/2"(F)x3/8"(M) | 46 | 68 | 10 |



3/8"DR. Universal deep socket

| Part no. | socket | mm | g | pc/box |
|--------------|--------|----|-----|--------|
| 805358510 | 10 | 85 | 82 | 10 |
| 805358511 | 11 | 85 | 86 | 10 |
| 805358512 | 12 | 85 | 92 | 10 |
| 805358513 | 13 | 85 | 92 | 10 |
| 805358514 | 14 | 85 | 104 | 10 |
| 805358515 | 15 | 85 | 108 | 10 |
| 805358516 | 16 | 85 | 112 | 10 |
| 805358517 | 17 | 85 | 121 | 10 |
| 805358518 | 18 | 85 | 136 | 10 |
| 805358519 | 19 | 85 | 136 | 10 |
| 80535853.8 | 3/8" | 85 | 82 | 10 |
| 80535857.16 | 7/16" | 85 | 86 | 10 |
| 80535851.2 | 1/2" | 85 | 92 | 10 |
| 80535859.16 | 9/16" | 85 | 92 | 10 |
| 80535855.8 | 5/8" | 85 | 112 | 10 |
| 805358511.16 | 11/16" | 85 | 121 | 10 |
| 80535853.4 | 3/4" | 85 | 136 | 10 |



3/8"DR. Spark plug socket

| Part no. | size | mm | g | pc/box |
|----------|--------|----|-----|--------|
| 807316 | 16mm | 63 | 96 | 10 |
| 807318 | 18mm | 63 | 125 | 10 |
| 807320.6 | 20.6mm | 63 | 150 | 10 |



3/8"DR. Magnetic spark plug socket

| Part no. | size | mm | g | pc/box |
|--------------------|--------|----|-----|--------|
| 807314M NEW | 14mm | 70 | 73 | 10 |
| 807316M | 16mm | 70 | 80 | 10 |
| 807318M | 18mm | 70 | 122 | 10 |
| 807320.6M | 20.6mm | 70 | 151 | 10 |



3/8"DR. Locking extension

| Part no. | mm | g | pc/box |
|----------|---------|-----|--------|
| 808306 | 150-6" | 157 | 200 |
| 808310 | 250-10" | 249 | 100 |
| 808318 | 450-18" | 484 | 25 |

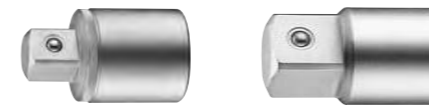

3/8" DR. Adaptor

| Part no. | size | mm | g | pc/box |
|----------|------------------|----|----|--------|
| 80932 | 3/8(F) x 1/4"(M) | 35 | 31 | 10 |
| 80934 | 3/8(F) x 1/2"(M) | 46 | 47 | 10 |

NEW



Adaptor extension

| Part no. | size(mm) | L(mm) | weight(gw) |
|----------|-------------------|-------|------------|
| 80934062 | 3/8"(F) - 1/2"(M) | 61.5 | 85 |



3/8" Bit adaptor

| Part no. | size | mm | g | pc/box |
|----------|-------------------|----|----|--------|
| 8095330 | 5/16"Hex-3/8" Sq. | 30 | 16 | 20 |



3/8" DR. Bit holder

| Part no. | size | mm | g | pc/box |
|----------|------------------|----|----|--------|
| 81032 | 3/8"(F)x1/4"(F) | 30 | 27 | 20 |
| 81035 | 3/8"(F)x5/16"(F) | 30 | 38 | 20 |
| 81037 | 3/8"(F)x10mm(F) | 30 | 38 | 20 |



3/8" DR. Plastic hanger

| Part no. | size | mm | g |
|----------|---------|----|---|
| 8163 | 3/8"DR. | 67 | 4 |



3/8" DR. Speed T handle

| Part no. | mm | g | pc/box |
|----------|-----|-----|--------|
| 8193T | 250 | 449 | 10 |



3/8" DR. Socket rail

| Part no. | PCS | L(mm) | WT(gw) |
|----------|-----|-------|--------|
| 819307 | 7 | 160 | 26 |
| 819313 | 13 | 280 | 46 |
| 819320 | 20 | 560 | 126 |



4pc Star socket bit set

| | | | |
|---------------------------------------|-------------------|--------------------|------|
| 4041 | | | |
| Part no. | Bit | 20/17.0/18.0/0.82' | 850g |
| Content: 1/2"DR. 2-Star socket bit | | | |
| 346120 40...45 | T40; T45 (120mmL) | | |
| 346140 50...55 | T50; T55 (140mmL) | | |



5pc Star socket bit set

| | | | |
|---------------------------------------|---------------------------------|-------------------|------|
| 4051 | | | |
| Part no. | Bit | 30/19.3/20.3/0.9' | 643g |
| Content: 1/2"DR. 5-Star socket bit | | | |
| 346055 40...60 | T40; T45; T50; T55; T60 (55mmL) | | |



5pc 1/2" Hex socket bit set

| | | | |
|--------------------------------------|-------------------|-----------------|------|
| 4056 | | | |
| Part no. | Bit | 20/17.0/18.0/1' | 850g |
| Content: 1/2"DR. 5-Hex socket bit | | | |
| 344055 10...12 | 10; 12 mm (55mmL) | | |
| 34406514 | 14 mm (65mmL) | | |
| 344070 17...19 | 17; 19 mm (70mmL) | | |



5pc Accessory set

| | | |
|------------------|---------------------------|-------|
| 4057 | | |
| Part no. | 6/15.0/16.0/0.9' | 2500g |
| Content: 1/2"DR. | | |
| 80249 | 1-72 teeth ratchet handle | |
| 8044 125...250 | 2-Extension bar 5"; 10" | |
| 8034250 | 1-Sliding T handle | |
| 80541 | 1-Universal joint | |



5pc Specialty set

| | | |
|------------------|---|------|
| 4059 | | |
| Part no. | 20/13.0/14.0/1.3 | 650g |
| Content: 1/2"DR. | | |
| 348140 08...12 | 3-1/2" Spline socket bit M8; M10; M12 (140mmL) | |
| 34413008 | 1-1/2" Hex socket bit 8mm (130mmL) | |
| 34410508B | 1-1/2" Bent hex socket bit 8mm (105mmL) | |



6pc Star socket bit set

| | | | |
|---|------------------------------|--------------------|------|
| 4062 | | | |
| Part no. | Bit | 25/15.8/16.8/0.64' | 632g |
| Content: 1/2"DR. 6-Star socket bit (55mmL) | | | |
| 346055 25...55 | T25; T30; T40; T45; T50; T55 | | |



4pc Star socket bit set

| | | | |
|---------------------------------------|-----------------------------|-------------------|------|
| 4042 | | | |
| Part no. | Bit | 40/20.6/21.6/1.4' | 515g |
| Content: 1/2"DR. 4-Star socket bit | | | |
| 346100 40...70 | T40; T45; T55; T70 (100mmL) | | |



6pc 1/2" Spline socket bit set

| | | | |
|------------------|--|--------------------|-------|
| 4061 | | | |
| Part no. | Bit | 20/21.0/22.0/0.82' | 1050g |
| Content: 1/2"DR. | | | |
| 348055 06...10 | 6-Spline socket bit M6; M8; M10 (55mmL) | | |
| 348100 08...12 | M8; M10; M12 (100mmL) | | |



6pc 10mm Spline bit set

| | | | |
|------------------|---|--------------------|------|
| 4066 | | | |
| Part no. | Bit | 100/13.0/14.0/3.1' | 130g |
| Content: 1/2"DR. | | | |
| 17830 05...12 | 5-10mm spline bit (30mmL) M5; M6; M8; M10; M12 | | |
| 81047 | 1-Bit holder 1/2"DR.x10mm | | |



6pc Accessory set

| | | |
|------------------|-------------------------|-------|
| 40612 | | |
| Part no. | 6/16.5/17.5/0.9' | 2750g |
| Content: 1/2"DR. | | |
| 802415 | 1-Ratchet handle | |
| 8044 125...250 | 2-Extension bar 5"; 10" | |
| 8034250 | 1-Sliding T handle | |
| 80541 | 1-Universal joint | |
| 8014380 | 1-Swivel handle 15" | |



6pc Accessory set

| | | |
|------------------|--|-------|
| 40613-23 | | |
| Part no. | 6/16.5/17.5/0.9' | 2750g |
| Content: 1/2"DR. | | |
| 802423 | 1-72 teeth flexible round ratchet handle | |
| 8044 125...250 | 2-Extension bar 5"; 10" | |
| 8034250 | 1-Sliding T handle | |
| 80541 | 1-Universal joint | |
| 8014380 | 1-Swivel handle 15" | |



7pc 10mm Spline bit set

| | | | |
|-------------------|---------------------------|-------------------|------|
| 4072 | | | |
| Part no. | Bit | 60/16.5/17.5/1.3' | 275g |
| Content: 1/2"DR. | | | |
| 6-10mm Spline bit | | | |
| 17830 06...10 | M6; M8; M10 (30mmL) | | |
| 17875 08...12 | M8; M10; M12 (75mmL) | | |
| 81047 | 1-Bit holder 1/2"DR.x10mm | | |



7pc 1/2" 6pt Flank deep socket set

| | | | |
|-------------------------|------------------------------|-----------------|-------|
| 40711 | | | |
| Part no. | Socket | 12/16.1/17.1/1' | 1340g |
| Content: 1/2"DR. | | | |
| 7-6pt Flank deep socket | | | |
| 54577 08...19 | 8; 10; 12; 13; 14; 17; 19 mm | | |

7pc 1/2" 12pt Flank deep socket set

| | | | |
|--------------------------|------------------------------|-----------------|-------|
| 40711-9 | | | |
| Part no. | Socket | 12/16.1/17.1/1' | 1340g |
| Content: 1/2"DR. | | | |
| 7-12pt Flank deep socket | | | |
| 54977 08...19 | 8; 10; 12; 13; 14; 17; 19 mm | | |



7pc 10mm Star bit set

| | | | |
|-------------------------|------------------------------|--------------------|------|
| 4074 | | | |
| Part no. | Bit | 100/14.0/15.0/3.1' | 140g |
| Content: 1/2"DR. | | | |
| 6-10mm Star bit (30mmL) | | | |
| 17630 25...55 | T25; T30; T40; T45; T50; T55 | | |
| 81047 | 1-Bit holder 1/2"DR.x10mm | | |



8pc 10mm Star bit set

| | | | |
|-------------------------|-----------------------------------|--------------------|------|
| 4081 | | | |
| Part no. | Bit | 100/19.0/20.0/1.6' | 190g |
| Content: 1/2"DR. | | | |
| 7-10mm Star bit (30mmL) | | | |
| 17630 20...55 | T20; T25; T30; T40; T45; T50; T55 | | |
| 81047 | 1-Bit holder 1/2"DR.x10mm | | |
| 4081-3 | | | |
| Part no. | Bit | 100/19.0/20.0/1.6' | 190g |
| Content: 3/8"DR. | | | |
| 81037 | 1-Bit holder 3/8"DR.x10mm | | |



7pc 10mm Hex bit set

| | | | |
|------------------------|---------------------------|--------------------|------|
| 4075 | | | |
| Part no. | Bit | 100/14.0/15.0/3.1' | 140g |
| Content: 1/2"DR. | | | |
| 6-10mm hex bit (30mmL) | | | |
| 17430 04...12 | 4; 5; 6; 8; 10; 12 mm | | |
| 81047 | 1-Bit holder 1/2"DR.x10mm | | |



6pc Accessory set

| | | |
|------------------|---------------------------|-------|
| 40613 | | |
| Part no. | 6/16.5/17.5/0.9' | 2750g |
| Content: 1/2"DR. | | |
| 802418 | 1-Flexible ratchet handle | |
| 8044 125...250 | 2-Extension bar 5"; 10" | |
| 8034250 | 1-Sliding T handle | |
| 80541 | 1-Universal joint | |
| 8014380 | 1-Swivel handle 15" | |



1/2" Star deep socket set

| | | | |
|--------------------|-------------------------------------|-----------------|-------|
| 40615 | | | |
| Part no. | Socket | 12/14.8/15.8/1' | 1240g |
| Content: 1/2"DR. | | | |
| 6-Star deep socket | | | |
| 54677 08...18 | E8; E10; E12; E14; E16; E18 (77mmL) | | |



7pc Star socket set

| | | | |
|------------------|-----------------------------------|-------------------|-------|
| 4071 | | | |
| Part no. | Socket | 20/20.0/21.0/1.1' | 1000g |
| Content: 1/2"DR. | | | |
| 7-Star socket | | | |
| 546 10...24 | E10; E12; E14; E16; E18; E20; E24 | | |



8pc 1/2" Deep socket set (MM)

| | | | |
|---------------|---|-----------------|-------|
| 4082 | | | |
| Part no. | Socket | 12/17.3/18.3/1' | 1440g |
| 54577 13...24 | Content: 1/2"DR. 8-6pt. Flank deep socket (77mmL) 13; 14; 15; 17; 19; 21; 22; 24 mm | | |

8pc 1/2" Deep socket set (SAE)

| | | | |
|-------------------|--|-----------------|-------|
| 4082S | | | |
| Part no. | Socket | 12/17.3/18.3/1' | 1440g |
| 54577 1.2...15.16 | Content: 1/2"DR. 8-6pt. Flank deep socket (77mmL) 1/2"; 9/16"; 5/8"; 11/16"; 3/4"; 13/16"; 7/8"; 15/16" | | |



8pc Star deep socket set

| | | | |
|---------------|---|-----------------|-------|
| 4083 | | | |
| Part no. | Socket | 12/13.5/14.5/1' | 1125g |
| 54677 10...24 | Content: 1/2"DR. 8-Star deep socket (77mmL) E10; E11; E12; E14; E16; E18; E20; E24 | | |



8pc 1/2" Universal deep socket set (MM)

| | | | |
|------------------|--|-----------------|-------|
| 4084 | | | |
| Part no. | Socket | 15/28.5/29.5/1' | 1900g |
| 80545108 13...24 | Content: 1/2"DR. 8-Universal deep socket 13; 14; 15; 17; 19; 21; 22; 24 mm | | |

8pc 1/2" Universal deep socket set (SAE)

| | | | |
|----------------------|---|-----------------|-------|
| 4084S | | | |
| Part no. | Socket | 15/28.5/29.5/1' | 1900g |
| 80545108 1.2...15.16 | Content: 1/2"DR. 8-Universal deep socket 1/2"; 9/16"; 5/8"; 11/16"; 3/4"; 13/16"; 7/8"; 15/16" | | |



8pc 1/2" Universal socket set (MM)

| | | | |
|---------------|---|-----------------|-------|
| 4085 | | | |
| Part no. | Socket | 15/22.5/23.5/1' | 1500g |
| 80545 13...24 | Content: 1/2"DR. 8-Universal socket 13; 14; 15; 17; 19; 21; 22; 24 mm | | |

8pc 1/2" Universal socket set (SAE)

| | | | |
|-------------------|--|-----------------|-------|
| 4085S | | | |
| Part no. | Socket | 15/22.5/23.5/1' | 1500g |
| 80545 1.2...15.16 | Content: 1/2"DR. 8-Universal socket 1/2"; 9/16"; 5/8"; 11/16"; 3/4"; 13/16"; 7/8"; 15/16" | | |



8pc 1/2" Adapter set

| | | | |
|--------------|--|-------------------|-------|
| K4087 | | | |
| Part no. | ADAPTER | 24/26.5/27.5/1.5' | 1750g |
| 809 23...86 | Content: 1/2"DR. 8-Adapter 1/4"(F)x3/8"(M); 3/8"(F)x1/4"(M); 3/8"(F)x1/2"(M); 1/2"(F)x3/8"(M); 1/2"(F)x3/4"(M); 3/4"(F)x1/2"(M); 3/4"(F)x1"(M); 1"(F)x3/4"(M) | | |

NEW



8pc 1/2"DR. Spline socket bit set

| | | | |
|----------------|--|--------------------|------|
| 40811 | | | |
| Part no. | Socket | 20/19.2/20.2/0.82' | 960g |
| 348055 05...16 | Content: 1/2"DR. 8-Spline socket bit (55mmL) M5; M6; M8; M9; M10; M12; M14; M16 | | |



8pc 1/2" Hex socket bit set (MM)

| | | | |
|----------------|---|--------------------|-------|
| 4091 | | | |
| Part no. | Bit | 20/22.5/23.5/0.82' | 1125g |
| 344055 05...12 | Content: 1/2"DR. 8-Hex socket bit 5; 6; 7; 8; 10; 12 mm (55mmL) | | |
| 34406514 | 14 mm (65mmL) | | |
| 34407017 | 17 mm (70mmL) | | |

8pc 1/2" Hex socket bit set (SAE)

| | | | |
|-------------------|--|--------------------|-------|
| 4091S | | | |
| Part no. | Bit | 20/22.5/23.5/0.82' | 1125g |
| 344055 5.32...1.2 | Content: 1/2"DR. 8-Hex socket bit 5/32"; 3/16"; 1/4"; 5/16"; 3/8"; 1/2" (55mmL) | | |
| 344065 9.16...5.8 | 9/16"; 5/8" (65mmL) | | |



8pc 1/2" Hex socket bit set (MM)

| | | | |
|----------------|--|-----------------|-------|
| 4092 | | | |
| Part no. | Bit | 10/19.8/20.8/1' | 1980g |
| 344110 05...17 | Content: 1/2"DR. 8-Hex socket bit (110mmL) 5; 6; 7; 8; 10; 12; 14; 17 mm | | |



9pc Star socket set

| | | | |
|-------------|---|-------------------|-------|
| 4093 | | | |
| Part no. | Socket | 20/24.0/25.0/1.1' | 1200g |
| 546 10...24 | Content: 1/2"DR. 9-Star socket E10; E11; E12; E14; E16; E18; E20; E22; E24 | | |



9pc Star socket set

| | | | |
|----------------------------|--|-------------------|------|
| 4095 | | | |
| Part no. | Socket | 36/23.3/24.3/1.6' | 647g |
| 536 10...14 546 16...24 | Content: 3/8" & 1/2"DR. 9-Star socket 3/8"DR.: E10; E11; E12; E14; 1/2"DR.: E16; E18; E20; E22; E24 | | |

NEW



9pc 1/2" 6pt Flank deep socket set

| | | | |
|---------------|--|-----------------|-------|
| 40911 | | | |
| Part no. | Socket | 12/17.3/18.3/1' | 1440g |
| 54577 10...24 | Content: 1/2"DR. 9-6pt Flank deep socket 10; 12; 13; 14; 17; 19; 21; 22; 24 mm | | |

9pc 1/2" 12pt Flank deep socket set

| | | | |
|----------------|---|-----------------|-------|
| 40911-9 | | | |
| Part no. | Socket | 12/17.3/18.3/1' | 1440g |
| 54977 10...24 | Content: 1/2"DR. 9-12pt Flank deep socket 10; 12; 13; 14; 17; 19; 21; 22; 24 mm | | |



9pc 1/2" Hex socket bit set (MM)

| | | | |
|--|--|-----------------|-------|
| 4101 | | | |
| Part no. | Bit | 15/20.0/21.0/1' | 1334g |
| 344055 04...12 34406514 34407017 | Content: 1/2"DR. 9-Hex socket bit 4; 5; 6; 7; 8; 10; 12 mm (55mmL) 14 mm (65mmL) 17 mm (70mmL) | | |

9pc 1/2" Hex socket bit set (SAE)

| | | | |
|--|--|-----------------|-------|
| 4101S | | | |
| Part no. | Bit | 15/20.0/21.0/1' | 1334g |
| 344055 5.32...1.2 344065 9.16...5.8 | Content: 1/2"DR. 9-Hex socket bit 5/32"; 3/16"; 7/32"; 1/4"; 5/16"; 3/8"; 1/2" (55mmL) 9/16"; 5/8" (65mmL) | | |



9pc Star socket bit set

| | | | |
|----------------|---|--------------------|-------|
| 4102 | | | |
| Part no. | Bit | 20/22.0/23.0/0.82' | 1100g |
| 346055 20...60 | Content: 1/2"DR. 9-Star socket bit T20; T25; T27; T30; T40; T45; T50; T55; T60 (55mmL) | | |



10pc 1/2" Socket set (MM)

| | | | |
|-------------|---|-------------------|------|
| 4106 | | | |
| Part no. | Socket | 20/16.0/17.0/1.3' | 800g |
| 545 11...24 | Content: 1/2"DR. 10-1/2" 6pt. Flank socket 11; 12; 13; 14; 15; 17; 19; 21; 22; 24 mm | | |

10pc 1/2" Socket set (SAE)

| | | | |
|-----------------|--|-------------------|------|
| 4106S | | | |
| Part no. | Socket | 20/16.0/17.0/1.3' | 800g |
| 545 3.8...15.16 | Content: 1/2"DR. 10-1/2" 6pt. Flank socket 3/8"; 7/16"; 1/2"; 9/16"; 5/8"; 11/16"; 3/4"; 13/16"; 7/8"; 15/16" | | |



10pc Spline deep socket set

| | | | |
|---------------|---|-------------------|-------|
| 41014Q | | | |
| Part no. | Socket | 24/36.0/37.0/1.4' | 1500g |
| 54Q77 10...24 | Content: 1/2"DR. 10-Spline deep socket (77mmL) 10; 11; 12; 13; 14; 15; 17; 19; 22; 24 mm | | |



10pc 1/2" Hex socket bit set (MM)

| | | | |
|--|---|-----------------|-------|
| 4111 | | | |
| Part no. | Bit | 15/23.4/24.4/1' | 1560g |
| 344055 04...12 34406514 344070 17...19 | Content: 1/2"DR. 10-Hex socket bit 4; 5; 6; 7; 8; 10; 12 mm (55mmL) 14 mm (65mmL) 17; 19 mm (70mmL) | | |

10pc 1/2" Hex socket bit set (SAE)

| | | | |
|---|---|-----------------|-------|
| 4111S | | | |
| Part no. | Bit | 15/23.4/24.4/1' | 1560g |
| 344055 5.32...1.2 344065 9.16...5.8 3440703.4 | Content: 1/2"DR. 10-Hex socket bit 5/32"; 3/16"; 7/32"; 1/4"; 5/16"; 3/8"; 1/2" (55mmL) 9/16"; 5/8" (65mmL) 3/4" (70mmL) | | |



11pc 10mm Spline bit set

| | | | |
|--|------------------------------|--------------------|------|
| 4112 | | | |
| Part no. | Bit | 20/10.3/11.3/0.82' | 515g |
| Content: 1/2"DR. 10-10mm Spline bit | | | |
| 17830 05...12 | M5; M6; M8; M10; M12 (30mmL) | | |
| 17875 05...12 | M5; M6; M8; M10; M12 (75mmL) | | |
| 81047 | 1-Bit holder 1/2"DR.x10mm | | |



11pc Star socket set

| | | | |
|--|-----------------------------|-------------------|------|
| 4113 | | | |
| Part no. | Socket | 36/16.5/17.5/1.6' | 458g |
| Content: 1/4" & 3/8" & 1/2"DR. 11-Star socket | | | |
| 526 05...08 | 1/4"DR.: E5; E6; E7; E8 | | |
| 536 10...14 | 3/8"DR.: E10; E11; E12; E14 | | |
| 546 16...20 | 1/2"DR.: E16; E18; E20 | | |

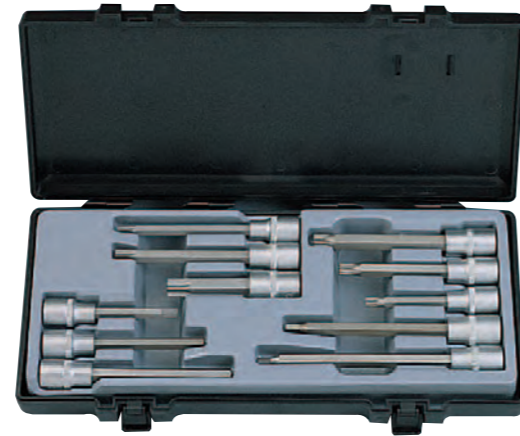

11pc Socket bit set

| | | |
|------------------|---|-------|
| 4116 | | |
| Part no. | 6/13.5/14.5/0.9' | 2250g |
| Content: 1/2"DR. | | |
| 344 | 5-Hex socket bit | |
| 18005...14010 | 5mm (180mmL); 6mm (160mmL); 7mm (100mmL); 8mm (120mmL); 10mm (140mmL) | |
| 346140 45...55 | 3-Star socket bit | |
| 34610070 | T45; T55 (140mmL) T70 (100mmL) | |
| 348100 08...10 | 3-Spline socket bit | |
| 34814012 | M8 (100mmL); M10 (120mmL) M12 (140mmL) | |



12pc Socket bit set

| | | |
|------------------|--|-------|
| 4122 | | |
| Part no. | 6/13.0/14.0/0.9' | 2160g |
| Content: 1/2"DR. | | |
| 34418005 | 4-Hex socket bit | |
| 344100 06...08 | 5mm (180mmL) 6; 7; 8 mm (100mmL) | |
| 346120 40...45 | 4-Star Socket bit | |
| 346140 55...70 | T40; T45 (120mmL) T55; T70 (140mmL) | |
| 348100 06...12 | 4-Spline socket bit | |
| | M6; M8; M10; M12 (100mmL) | |



12pc Spline socket set

| | | | |
|--------------------------------------|--|-------------------|------|
| 4124Q | | | |
| Part no. | Socket | 36/29.0/30.0/1.6' | 806g |
| Content: 1/2"DR. 12-Spline socket | | | |
| 54Q 10...24 | 10; 11; 12; 13; 14; 15; 16; 17; 19; 21; 22; 24 mm | | |



13pc Hex socket bit set

| | | | |
|------------------|--|------------------|-------|
| 4141 | | | |
| Part no. | Bit | 6/21.0/22.0/0.9' | 3500g |
| Content: 1/2"DR. | | | |
| 344055 04...12 | 9-Hex socket bit | | |
| 34406514 | 4; 5; 6; 8; 10; 12 mm (55mmL) 14 mm (65mmL) | | |
| 344070 17...19 | 17; 19 mm (70mmL) | | |
| 80243 | 1-Ratchet handle | | |
| 8044125 | 1-Extension bar 5" | | |
| 8034300 | 1-Sliding T handle 12" | | |
| 80541 | 1-Universal joint | | |



14pc 1/2" Deep socket set

| | | | |
|--|--|------------------|-------|
| 4143 | | | |
| Part no. | Socket | 6/18.6/19.6/0.9' | 3100g |
| Content: 1/2"DR. 14-6pt. Flank deep socket | | | |
| 54577 10...32 | 10; 12; 13; 14; 15; 17; 19; 21; 22; 23; 24; 27; 30; 32 mm | | |
| 4143-9 | | | |
| Part no. | Socket | 6/18.6/19.6/0.9' | 3100g |
| Content: 1/2"DR. 14-12pt. Flank deep socket | | | |
| 54977 10...32 | 10; 12; 13; 14; 15; 17; 19; 21; 22; 23; 24; 27; 30; 32 mm | | |



15pc 10mm Hex bit set

| | | | |
|------------------|--|--------------------|------|
| 4155 | | | |
| Part no. | Bit | 20/16.0/17.0/0.82' | 800g |
| Content: 1/2"DR. | | | |
| 17430 04...12 | 14-10mm Hex bit | | |
| 17475 04...12 | 4; 5; 6; 7; 8; 10; 12 mm (30mmL) 4; 5; 6; 7; 8; 10; 12 mm (75mmL) | | |
| 81047 | 1-Bit holder 1/2"DR.x10mm | | |



15pc 10mm Star bit set

| | | | |
|---------------|--|--------------------|------|
| 4156 | | | |
| Part no. | Bit | 20/16.0/17.0/0.82' | 800g |
| 17630 20...55 | Content: 1/2"DR. 7-10mm Star bit (30mmL) T20; T25; T30; T40; T45; T50; T55 | | |
| 17675 20...55 | 7-10mm Star bit (75mmL) T20; T25; T30; T40; T45; T50; T55 | | |
| 81047 | 1-Bit holder 1/2"DR.x10mm | | |



14pc Star set

| | | | |
|---------------|---|--------------------|------|
| 4157 | | | |
| Part no. | Bit | 20/18.0/19.0/0.82' | 900g |
| 546 10...20 | Content: 1/2"DR. 6-Star socket E10; E12; E14; E16; E18; E20 | | |
| 17630 25...55 | 7-10mmL Star bit (30mmL) T25; T27; T30; T40; T45; T50; T55 | | |
| 81047 | 1-Bit holder 1/2"DR.x10mm | | |



14pc Star socket set

| | | | |
|-------------|---|-----------------|------|
| 4158 | | | |
| Part no. | Socket | 20/13.0/14.0/1' | 650g |
| 526 04...08 | Content: 1/4" & 3/8" & 1/2"DR. 5-1/4"DR. Star socket E4; E5; E6; E7; E8 | | |
| 536 10...14 | 4-3/8"DR. Star socket E10; E11; E12; E14 | | |
| 546 16...24 | 5-1/2"DR. Star socket E16; E18; E20; E22; E24 | | |

NEW



15pc 1/2"DR. WW socket set

| | | | |
|-----------------|--|------------------|-------|
| 41512 | | | |
| Part no. | Socket | 6/21.6/22.6/0.8' | 3600g |
| 548W 3.16...3.4 | Content: 1/2"DR. 9-12pt. WW flank socket 3/16"; 1/4"; 5/16"; 3/8"; 7/16"; 1/2"; 9/16"; 5/8"; 3/4" | | |
| 8014250 | 1-Swivel handle 10" | | |
| 80244 | 1-Ratchet handle | | |
| 8044125W | 1-Wobble extension 5" | | |
| 8044250 | 1-Extension 10" | | |
| 80541 | 1-Universal joint | | |
| 80634 | 1-Adaptor for 1/2"DR. extension 3/8"(F) x 1/2"(M) | | |



NEW



15pc 1/2" 6pt. Deep socket set

| | | | |
|---------------|--|------------------|-------|
| K41513 | | | |
| Part no. | Socket | 6/19.4/20.4/1.5' | 3.2kg |
| 54577 10...30 | Content: 1/2"DR. 15-6pt. Deep socket 10, 12, 13, 14, 15, 16, 17, 18, 19, 21, 22, 24, 26, 27, 30mm | | |



16pc Socket set

| | | | |
|---------------|---|-------------------|-------|
| 4161 | | | |
| Part no. | Socket | 6/20.8/21.8/0.68' | 3466g |
| 545 10...27 | Content: 1/2"DR. 13-6pt. Flank socket 10; 11; 12; 13; 14; 15; 17; 19; 21; 22; 24; 26; 27 mm | | |
| 80244 | 1-Ratchet handle | | |
| 8044125 | 1-Extension bar 5" | | |
| 8014380 | 1-Swivel handle 15" | | |
| 4161-7 | | | |
| Part no. | Socket | 6/20.8/21.8/0.68' | 3466g |
| Changed Items | Content: 1/2"DR. 13-Surface drive socket 10; 11; 12; 13; 14; 15; 17; 19; 21; 22; 24; 26; 27 mm | | |

| | | | |
|---------------|---|-------------------|-------|
| 4161-9 | | | |
| Part no. | Socket | 6/20.8/21.8/0.68' | 3466g |
| Changed Items | Content: 1/2"DR. 13-12pt. Flank socket 10; 11; 12; 13; 14; 15; 17; 19; 21; 22; 24; 26; 27 mm | | |



16pc Socket set

| | | | |
|---------------|---|------------------|-------|
| 4162 | | | |
| Part no. | Socket | 6/21.0/22.0/0.7' | 3500g |
| 549 10...32 | Content: 1/2"DR. 12-12pt. Flank socket 10; 11; 12; 13; 14; 17; 19; 22; 24; 27; 30; 32 mm | | |
| 80242 | 1-Ratchet handle | | |
| 8034300 | 1-Sliding T handle 12" | | |
| 8044125 | 1-Extension bar 5" | | |
| 80541 | 1-Universal joint | | |
| 4162-5 | | | |
| Part no. | Socket | 6/21.0/22.0/0.7' | 3500g |
| Changed Items | Content: 1/2"DR. 12-6pt. Flank socket 10; 11; 12; 13; 14; 17; 19; 22; 24; 27; 30; 32 mm | | |
| 4162-7 | | | |
| Part no. | Socket | 6/21.0/22.0/0.7' | 3500g |
| Changed Items | Content: 1/2"DR. 12-Surface drive socket 10; 11; 12; 13; 14; 17; 19; 22; 24; 27; 30; 32 mm | | |



16pc Star set

| | | | |
|------------------|---|-------------------|-------|
| 4171 | | | |
| Part no. | Bit | 10/20.0/21.0/0.7' | 2000g |
| Content: 1/2"DR. | | | |
| 546 10...24 | 9-Star socket E10; E11; E12; E14; E16; E18; E20; E22; E24 | | |
| 346055 30...70 | 7-Star socket bit (55mmL) T30; T40; T45; T50; T55; T60; T70 | | |
| 4172 | | | |
| Part no. | Bit | 10/20.0/21.0/0.7' | 2000g |
| Content: 1/2"DR. | | | |
| 546 10...24 | 9-Star socket E10; E11; E12; E14; E16; E18; E20; E22; E24 | | |
| 346055 40...70 | 7-Star socket bit (55mmL) T40; T45; T47; T50; T55; T60; T70 | | |



17pc Socket set (MM)

| | | | |
|------------------|--|------------------|-------|
| 4173 | | | |
| Part no. | Socket | 6/16.0/17.0/0.7' | 2660g |
| Content: 1/2"DR. | | | |
| 547 08...26 | 13-Surface drive socket 8; 10; 11; 12; 13; 14; 15; 16; 17; 19; 21; 23; 26 mm | | |
| 80243 | 1-Ratchet handle | | |
| 807420.6 | 1-Spark plug socket 20.6mm | | |
| 8034250 | 1-Sliding T handle | | |
| 8044125 | 1-Extension bar 5" | | |
| 4173-5 | | | |
| Part no. | Socket | 6/16.0/17.0/0.7' | 2660g |
| Content: 1/2"DR. | | | |
| 545 08...26 | 13-6pt. Flank socket 8; 10; 11; 12; 13; 14; 15; 16; 17; 19; 21; 23; 26 mm | | |
| 4173-9 | | | |
| Part no. | Socket | 6/16.0/17.0/0.7' | 2660g |
| Content: 1/2"DR. | | | |
| 549 08...26 | 13-12pt. Flank socket 8; 10; 11; 12; 13; 14; 15; 16; 17; 19; 21; 23; 26 mm | | |

17pc Socket set (SAE)

| | | | |
|------------------|--|------------------|-------|
| 4173S | | | |
| Part no. | Socket | 6/16.0/17.0/0.7' | 2660g |
| Content: 1/2"DR. | | | |
| 547 5.16...1 | 13-Surface drive socket 5/16"; 3/8"; 7/16"; 15/32"; 1/2"; 9/16"; 19/32"; 5/8"; 11/16"; 3/4"; 13/16"; 7/8"; 1" | | |

| | | | |
|------------------|--|------------------|-------|
| 4173S-5 | | | |
| Part no. | Socket | 6/16.0/17.0/0.7' | 2660g |
| Content: 1/2"DR. | | | |
| 545 5.16...1 | 13-6pt. Flank socket 5/16"; 3/8"; 7/16"; 15/32"; 1/2"; 9/16"; 19/32"; 5/8"; 11/16"; 3/4"; 13/16"; 7/8"; 1" | | |
| 4173S-9 | | | |
| Part no. | Socket | 6/16.0/17.0/0.7' | 2660g |
| Content: 1/2"DR. | | | |
| 549 5.16...1 | 13-12pt. Flank socket 5/16"; 3/8"; 7/16"; 15/32"; 1/2"; 9/16"; 19/32"; 5/8"; 11/16"; 3/4"; 13/16"; 7/8"; 1" | | |



17pc Socket set

| | | | |
|------------------|---|------------------|-------|
| 4181 | | | |
| Part no. | Socket | 6/19.5/20.5/0.7' | 3250g |
| Content: 1/2"DR. | | | |
| 545 10...26 | 13-6pt. Flank socket 10; 11; 12; 13; 14; 15; 16; 17; 18; 19; 21; 23; 26 mm | | |
| 80244 | 1-Ratchet handle | | |
| 8044125 | 1-Extension bar 5" | | |
| 8034250 | 1-Sliding T handle | | |
| 807420.6 | 1-Spark plug socket 20.6mm | | |
| 4181-7 | | | |
| Part no. | Socket | 6/19.5/20.5/0.7' | 3250g |
| Content: 1/2"DR. | | | |
| 547 10...26 | 13-Surface drive socket 10; 11; 12; 13; 14; 15; 16; 17; 18; 19; 21; 23; 26 mm | | |

| | | | |
|------------------|---|------------------|-------|
| 4181-9 | | | |
| Part no. | Socket | 6/19.5/20.5/0.7' | 3250g |
| Content: 1/2"DR. | | | |
| 549 10...26 | 13-12pt. Flank socket 10; 11; 12; 13; 14; 15; 16; 17; 18; 19; 21; 23; 26 mm | | |



18pc Star set

| | | | |
|-------------------------|--|-------------------|-------|
| 4192 | | | |
| Part no. | Bit | 10/16.5/17.5/0.7' | 1650g |
| Content: 3/8" & 1/2"DR. | | | |
| 536 10...18 | 6-3/8"DR. Star socket E10; E11; E12; E14; E16; E18 | | |
| 546 20...24 | 3-1/2"DR. Star socket E20; E22; E24 | | |
| 33650 20...40 | 5-3/8"DR. Star socket bit T20; T25; T27; T30; T40 (50mmL) | | |
| 346055 45...60 | 4-1/2"DR. Star socket bit T45; T50; T55; T60 (55mmL) | | |



19pc 1/2" Socket set

| | | | |
|------------------|---|------------------|-------|
| 4194 | | | |
| Part no. | Socket | 6/14.8/15.8/0.9' | 2470g |
| 545 5.16...1.1.4 | Content: 1/2"DR. 19-6pt. Flank socket 5/16"; 3/8"; 7/16"; 15/32"; 1/2"; 9/16"; 19/32"; 5/8"; 11/16"; 3/4"; 25/32"; 13/16"; 7/8"; 15/16"; 1"; 1-1/16"; 1-1/8"; 1-3/16"; 1-1/4" | | |
| 4194-7 | | | |
| Part no. | Socket | 6/14.8/15.8/0.9' | 2470g |
| Changed Items | Content: 1/2"DR. 19-Surface drive socket 5/16"; 3/8"; 7/16"; 15/32"; 1/2"; 9/16"; 19/32"; 5/8"; 11/16"; 3/4"; 25/32"; 13/16"; 7/8"; 15/16"; 1"; 1-1/16"; 1-1/8"; 1-3/16"; 1-1/4" | | |
| 4194-9 | | | |
| Part no. | Socket | 6/14.8/15.8/0.9' | 2470g |
| Changed Items | Content: 1/2"DR. 19-12pt. Flank socket 5/16"; 3/8"; 7/16"; 15/32"; 1/2"; 9/16"; 19/32"; 5/8"; 11/16"; 3/4"; 25/32"; 13/16"; 7/8"; 15/16"; 1"; 1-1/16"; 1-1/8"; 1-3/16"; 1-1/4" | | |



20pc Star set

| | | | |
|----------------|--|-----------------|-------|
| 4211 | | | |
| Part no. | Bit | 15/15.4/16.4/1' | 1026g |
| 546 10...14 | Content: 1/4" & 1/2"DR. 3-1/2"DR. Star socket E10; E12; E14 | | |
| 346055 40...60 | 5-1/2"DR. Star socket bit T40; T45; T50; T55; T60 (55mmL) | | |
| 12630 06...09 | 4-1/4" Star bit T6; T7; T8; T9 (30mmL) | | |
| 12730 | 6-1/4" Star tamperproof bit T-10H; T-15H; T-20H; T-25H; T-27H; T-30H (30mmL) | | |
| 10G...30G | 1-1/4"DR. Spinner | | |
| 8145 | 1-Bit holder 1/4"DR.x1/4" | | |
| 81022 | | | |



21pc Socket set

| | | | |
|---------------|---|------------------|-------|
| 4212 | | | |
| Part no. | Socket | 6/16.0/17.0/0.9' | 2666g |
| 545 08...32 | Content: 1/2"DR. 21-6pt. Flank socket 8; 10; 11; 12; 13; 14; 15; 16; 17; 18; 19; 20; 21; 22; 23; 24; 26; 27; 28; 30; 32 mm | | |
| 4212-7 | | | |
| Part no. | Socket | 6/16.0/17.0/0.9' | 2666g |
| Changed Items | Content: 1/2"DR. 21-Surface drive socket 8; 10; 11; 12; 13; 14; 15; 16; 17; 18; 19; 20; 21; 22; 23; 24; 26; 27; 28; 30; 32 mm | | |
| 547 08...32 | | | |
| 4212-9 | | | |
| Part no. | Socket | 6/16.0/17.0/0.9' | 2666g |
| Changed Items | Content: 1/2"DR. 21-12pt. Flank socket 8; 10; 11; 12; 13; 14; 15; 16; 17; 18; 19; 20; 21; 22; 23; 24; 26; 27; 28; 30; 32 mm | | |
| 549 08...32 | | | |



20pc Star set

| | | | |
|----------------|--|------------------|-------|
| 4213 | | | |
| Part no. | Bit | 6/19.5/20.5/0.9' | 3167g |
| 346055 20...60 | Content: 1/2"DR. 10-20-Star socket bit T20; T25; T27; T30; T40; T45; T47; T50; T55; T60 (55mmL) | | |
| 546 08...20 | 7-Star socket E8; E10; E12; E14; E16; E18; E20 | | |
| 80243 | 1-Ratchet handle | | |
| 8044125 | 1-Extension bar 5" | | |
| 80541 | 1-Universal joint | | |



21pc Socket set

| | | | |
|----------------|---|------------------|-------|
| 4214 | | | |
| Part no. | Socket | 6/20.0/21.0/0.9' | 3330g |
| 545 08...26 | Content: 1/2"DR. 15-6pt. Flank socket 8; 10; 11; 12; 13; 14; 15; 16; 17; 18; 19; 21; 22; 23; 26 mm | | |
| 80249 | 1-72 teeth ratchet handle | | |
| 8044 125...250 | 2-Extension bar 5" & 10" | | |
| 80541 | 1-Universal joint | | |
| 80634 | 1-Adaptor for extension 3/8"(F)x1/2"(M) | | |
| 807420.6 | 1-Spark plug socket 20.6mm | | |

| | | | |
|------------------------------|--|------------------|-------|
| 4214-7 | | | |
| Part no. | Socket | 6/20.0/21.0/0.9' | 3330g |
| Changed Items 547 08...26 | Content: 1/2"DR. 15-Surface drive socket 8; 10; 11; 12; 13; 14; 15; 16; 17; 18; 19; 21; 22; 23; 26 mm | | |

| | | | |
|------------------------------|--|------------------|-------|
| 4214-9 | | | |
| Part no. | Socket | 6/20.0/21.0/0.9' | 3330g |
| Changed Items 549 08...26 | Content: 1/2"DR. 15-12pt. Flank socket 8; 10; 11; 12; 13; 14; 15; 16; 17; 18; 19; 21; 22; 23; 26 mm | | |

22pc Star tamperproof bit set

| | | | |
|---------------|---|-----------------|-------|
| 4222 | | | |
| Part no. | Bit | 15/15.5/16.5/1' | 1033g |
| 17730 10...55 | Content: 3/8" & 1/2"DR. 20-10mm star tamperproof bit T-10H; T-15H; T-20H; T-25H; T-27H; T-30H; T-40H; T-45H; T-50H; T-55H (30mmL) | | |
| 17775 10...55 | T-10H; T-15H; T-20H; T-25H; T-27H; T-30H; T-40H; T-45H; T-50H; T-55H (75mmL) | | |
| 810 37...47 | 2-Bit holder 3/8"DR.x10mm; 1/2"DR.x10mm | | |

22pc Socket bit set

| | | | |
|----------------|--|------------------|-------|
| 4223 | | | |
| Part no. | Socket | 5/19.3/20.3/1.4' | 3860g |
| 545 10...32 | Content: 1/2"DR. 15-6pt. Flank Socket 10; 11; 12; 13; 14; 15; 16; 17; 18; 19; 22; 24; 27; 30; 32 mm | | |
| 80243 | 1-Ratchet handle | | |
| 8044 125...250 | 2-Extension bar 5" ; 10" | | |
| 8074 16...20.6 | 1-Spark plug socket 16 ; 20.6 mm | | |
| 80541 | 1-Universal joint | | |
| 80634 | 1-Adaptor for extension 3/8"(F)x1/2"(M) | | |

| | | | |
|------------------------------|---|------------------|-------|
| 4223-7 | | | |
| Part no. | Socket | 5/19.3/20.3/1.4' | 3860g |
| Changed Items 547 10...32 | Content: 1/2"DR. 15-Surface drive Socket 10; 11; 12; 13; 14; 15; 16; 17; 18; 19; 22; 24; 27; 30; 32 mm | | |

| | | | |
|------------------------------|---|------------------|-------|
| 4223-9 | | | |
| Part no. | Socket | 5/19.3/20.3/1.4' | 3860g |
| Changed Items 549 10...32 | Content: 1/2"DR. 15-12pt. Flank Socket 10; 11; 12; 13; 14; 15; 16; 17; 18; 19; 22; 24; 27; 30; 32 mm | | |

22pc Ribe bit set

| | | | |
|---------------|--|-----------------|-------|
| 4225 | | | |
| Part no. | Bit | 15/18.2/19.2/1' | 1230g |
| 17930 04...14 | Content: 3/8" & 1/2"DR. 20-10mm Ribe bit M4; M5; M6; M7; M8; M9; M10; M12; M13; M14 (30mmL) | | |
| 17975 04...14 | M4; M5; M6; M7; M8; M9; M10; M12; M13; M14 (75mmL) | | |
| 810 37...47 | 2-Bit holder 3/8"DR.x10mm; 1/2"DR.x10mm | | |



24pc Socket set (MM)

| | | | |
|----------------|--|------------------|-------|
| 4243 | | | |
| Part no. | Socket | 4/22.0/23.0/0.9' | 5500g |
| 547 10...32 | Content: 1/2"DR. 18-Surface drive socket 10; 11; 12; 13; 14; 15; 16; 17; 18; 19; 20; 21; 22; 23; 24; 27; 30; 32 mm | | |
| 80243 | 1-Ratchet handle | | |
| 8014380 | 1-Swivel handle 15" | | |
| 8044 125...250 | 2-Extension bar 5" ; 10" | | |
| 8034250 | 1-Sliding T handle | | |
| 80541 | 1-Universal joint | | |
| 4243-5 | | | |
| Part no. | Socket | 4/22.0/23.0/0.9' | 5500g |
| 545 10...32 | Content: 1/2"DR. 18-6pt. Flank socket 10; 11; 12; 13; 14; 15; 16; 17; 18; 19; 20; 21; 22; 23; 24; 27; 30; 32 mm | | |
| 4243-9 | | | |
| Part no. | Socket | 4/22.0/23.0/0.9' | 5500g |
| 549 10...32 | Content: 1/2"DR. 18-12pt. Flank socket 10; 11; 12; 13; 14; 15; 16; 17; 18; 19; 20; 21; 22; 23; 24; 27; 30; 32 mm | | |

22pc Socket set (SAE)

| | | | |
|------------------|---|------------------|-------|
| 4243S | | | |
| Part no. | Socket | 4/22.0/23.0/0.9' | 5500g |
| 547 5.16...1.1.4 | Content: 1/2"DR. 18-Surface drive socket 5/16"; 3/8"; 7/16"; 1/2"; 9/16"; 19/32"; 5/8"; 11/16"; 3/4"; 25/32"; 13/16"; 7/8"; 15/16"; 1"; 1-1/16"; 1-1/8"; 1-3/16"; 1-1/4" | | |
| 4243S-5 | | | |
| Part no. | Socket | 4/22.0/23.0/0.9' | 5500g |
| 545 5.16...1.1.4 | Content: 1/2"DR. 18-6pt. Flank socket 5/16"; 3/8"; 7/16"; 1/2"; 9/16"; 19/32"; 5/8"; 11/16"; 3/4"; 25/32"; 13/16"; 7/8"; 15/16"; 1"; 1-1/16"; 1-1/8"; 1-3/16"; 1-1/4" | | |
| 4243S-9 | | | |
| Part no. | Socket | 4/22.0/23.0/0.9' | 5500g |
| 549 5.16...1.1.4 | Content: 1/2"DR. 18-12pt. Flank socket 5/16"; 3/8"; 7/16"; 1/2"; 9/16"; 19/32"; 5/8"; 11/16"; 3/4"; 25/32"; 13/16"; 7/8"; 15/16"; 1"; 1-1/16"; 1-1/8"; 1-3/16"; 1-1/4" | | |



24pc Socket set (MM)

| | | | |
|----------------|--|------------------|-------|
| 4245 | | | |
| Part no. | Socket | 4/20.7/21.7/0.9' | 5175g |
| 545 10...32 | Content: 1/2"DR. 18-6pt. Flank socket 10; 11; 12; 13; 14; 15; 16; 17; 18; 19; 20; 21; 22; 23; 24; 27; 30; 32 mm | | |
| 80244 | 1-Ratchet handle | | |
| 8034250 | 1-Sliding T handle | | |
| 8044 125...250 | 2-Extension bar 5" ; 10" | | |
| 80541 | 1-Universal joint | | |
| 8154410A | 1-Speed handle | | |
| 4245-7 | | | |
| Part no. | Socket | 4/20.7/21.7/0.9' | 5175g |
| 547 10...32 | Content: 1/2"DR. 18-Surface drive socket 10; 11; 12; 13; 14; 15; 16; 17; 18; 19; 20; 21; 22; 23; 24; 27; 30; 32 mm | | |
| 4245-9 | | | |
| Part no. | Socket | 4/20.7/21.7/0.9' | 5175g |
| 549 10...32 | Content: 1/2"DR. 18-12pt. Flank socket 10; 11; 12; 13; 14; 15; 16; 17; 18; 19; 20; 21; 22; 23; 24; 27; 30; 32 mm | | |

24pc Socket set (SAE)

| | | | |
|------------------|---|------------------|-------|
| 4245S | | | |
| Part no. | Socket | 4/20.7/21.7/0.9' | 5175g |
| 545 5.16...1.1.4 | Content: 1/2"DR. 18-6pt. Flank socket 5/16"; 3/8"; 7/16"; 1/2"; 9/16"; 19/32"; 5/8"; 11/16"; 3/4"; 25/32"; 13/16"; 7/8"; 15/16"; 1"; 1-1/16"; 1/8"; 1-3/16"; 1-1/4" | | |
| 4245S-7 | | | |
| Part no. | Socket | 4/20.7/21.7/0.9' | 5175g |
| 547 5.16...1.1.4 | Content: 1/2"DR. 18-Surface drive socket 5/16"; 3/8"; 7/16"; 1/2"; 9/16"; 19/32"; 5/8"; 11/16"; 3/4"; 25/32"; 13/16"; 7/8"; 15/16"; 1"; 1-1/16"; 1/8"; 1-3/16"; 1-1/4" | | |
| 4245S-9 | | | |
| Part no. | Socket | 4/20.7/21.7/0.9' | 5175g |
| 549 5.16...1.1.4 | Content: 1/2"DR. 18-12pt. Flank socket 5/16"; 3/8"; 7/16"; 1/2"; 9/16"; 19/32"; 5/8"; 11/16"; 3/4"; 25/32"; 13/16"; 7/8"; 15/16"; 1"; 1-1/16"; 1/8"; 1-3/16"; 1-1/4" | | |



24pc Socket set (SAE)

| | | | |
|---------------|--------|------------------|-------|
| 4245BS | | | |
| Part no. | Socket | 4/20.7/21.7/0.9' | 5175g |

Changed Items
545 5.16...1.1.4

Content: 1/2"DR.
18-6pt. Flank socket
5/16"; 3/8"; 7/16"; 1/2"; 9/16";
19/32"; 5/8"; 11/16"; 3/4"; 25/32";
13/16"; 7/8"; 15/16"; 1"; 1-1/16";
1-1/8"; 1-3/16"; 1-1/4"

| | | | |
|-----------------|--------|------------------|-------|
| 4245BS-7 | | | |
| Part no. | Socket | 4/20.7/21.7/0.9' | 5175g |

Changed Items
547 5.16...1.1.4

Content: 1/2"DR.
18-Surface drive socket
5/16"; 3/8"; 7/16"; 1/2"; 9/16";
19/32"; 5/8"; 11/16"; 3/4"; 25/32";
13/16"; 7/8"; 15/16"; 1"; 1-1/16";
1-1/8"; 1-3/16"; 1-1/4"

24pc Socket set (MM)

| | | | |
|--------------|--------|------------------|-------|
| 4245B | | | |
| Part no. | Socket | 4/20.7/21.7/0.9' | 5175g |

545 10...32

Content: 1/2"DR.
18-6pt. Flank socket
10; 11; 12; 13; 14; 15; 16; 17; 18;
19; 20; 21; 22; 23; 24; 27; 30;
32 mm

80244 1-Ratchet handle
8034250 1-Sliding T handle
8044 125...250 2-Extension bar 5" ; 10"
80541 1-Universal joint
8014380 1-Swivel handle 15"

| | | | |
|----------------|--------|------------------|-------|
| 4245B-7 | | | |
| Part no. | Socket | 4/20.7/21.7/0.9' | 5175g |

Changed Items
547 10...32

Content: 1/2"DR.
18-Surface drive socket
10; 11; 12; 13; 14; 15; 16; 17; 18;
19; 20; 21; 22; 23; 24; 27; 30;
32 mm

| | | | |
|----------------|--------|------------------|-------|
| 4245B-9 | | | |
| Part no. | Socket | 4/20.7/21.7/0.9' | 5175g |

Changed Items
549 10...32

Content: 1/2"DR.
18-12pt. Flank socket
10; 11; 12; 13; 14; 15; 16; 17; 18;
19; 20; 21; 22; 23; 24; 27; 30;
32 mm



24pc Socket set (MM)

| | | | |
|-------------|--------|------------------|-------|
| 4246 | | | |
| Part no. | Socket | 4/20.6/21.6/0.9' | 5150g |

547 10...32

Content: 1/2"DR.
18-Surface drive socket
10; 11; 12; 13; 14; 15; 16; 17; 18;
19; 20; 21; 22; 23; 24; 27; 30;
32 mm

80243 1-Ratchet handle
8034250 1-Sliding T handle
8044 125...250 2-Extension bar 5" ; 10"
80541 1-Universal joint
807420.6 1-Spark plug socket 20.6mm

| | | | |
|---------------|--------|------------------|-------|
| 4246-5 | | | |
| Part no. | Socket | 4/20.7/21.7/0.9' | 5175g |

Changed Items
545 10...32

Content: 1/2"DR.
18-6pt. Flank socket
10; 11; 12; 13; 14; 15; 16; 17; 18;
19; 20; 21; 22; 23; 24; 27; 30;
32 mm

| | | | |
|---------------|--------|------------------|-------|
| 4246-9 | | | |
| Part no. | Socket | 4/20.7/21.7/0.9' | 5175g |

Changed Items
549 10...32

Content: 1/2"DR.
18-12pt. Flank socket
10; 11; 12; 13; 14; 15; 16; 17; 18;
19; 20; 21; 22; 23; 24; 27; 30;
32 mm

24pc Socket set (SAE)

| | | | |
|--------------|--------|------------------|-------|
| 4246S | | | |
| Part no. | Socket | 4/20.6/21.6/0.9' | 5150g |

Changed Items
547 5.16...1.1.4

Content: 1/2"DR.
18-Surface drive socket
5/16"; 3/8"; 7/16"; 1/2"; 9/16";
19/32"; 5/8"; 11/16"; 3/4"; 25/32";
13/16"; 7/8"; 15/16"; 1"; 1-1/16";
1-1/8"; 1-3/16"; 1-1/4"

| | | | |
|----------------|--------|------------------|-------|
| 4246S-5 | | | |
| Part no. | Socket | 4/20.7/21.7/0.9' | 5175g |

Changed Items
545 5.16...1.1.4

Content: 1/2"DR.
18-6pt. Flank socket
5/16"; 3/8"; 7/16"; 1/2"; 9/16";
19/32"; 5/8"; 11/16"; 3/4"; 25/32";
13/16"; 7/8"; 15/16"; 1"; 1-1/16";
1-1/8"; 1-3/16"; 1-1/4"

NEW



24pc 1/2" DR. Surface drive Socket set

| | | | |
|--------------|--------|---------------|-----|
| 4246B | | | |
| Part no. | Socket | 4/16/17/0.87' | 4kg |

547 10...32

Content: 1/2"DR.
18-Surface drive socket
10; 11; 12; 13; 14; 15; 16; 17; 18;
19; 20; 21; 22; 23; 24; 27; 30; 32mm

80243 1-Ratchet handle
8034250 1-Sliding T handle
8044 125...250 2-Extension bar 5" & 10"
80541 1-Universal joint
807420.6 1-Spark plug socket 20.6 mm

24pc 1/2" DR. 6pt. Flank socket set

| 4246B-5 | | | |
|------------------|---|---------------|-----|
| Part no. | Socket | 4/16/17/0.87' | 4kg |
| Content: 1/2"DR. | | | |
| 545 10...32 | 18-6pt. Flank socket 10; 11; 12; 13; 14; 15; 16; 17; 18; 19; 20; 21; 22; 23; 24; 27; 30; 32mm | | |
| 80243 | 1-Ratchet handle | | |
| 8034250 | 1-Sliding T handle | | |
| 8044 125...250 | 2-Extension bar 5" & 10" | | |
| 80541 | 1-Universal joint | | |
| 807420.6 | 1-Spark plug socket 20.6 mm (13/16") | | |

24pc 1/2" DR. 12pt. Flank socket set

| 4246B-9 | | | |
|------------------|--|---------------|-----|
| Part no. | Socket | 4/16/17/0.87' | 4kg |
| Content: 1/2"DR. | | | |
| 549 10...32 | 18-12pt. Flank socket 10; 11; 12; 13; 14; 15; 16; 17; 18; 19; 20; 21; 22; 23; 24; 27; 30; 32mm | | |
| 80243 | 1-Ratchet handle | | |
| 8034250 | 1-Sliding T handle | | |
| 8044 125...250 | 2-Extension bar 5" & 10" | | |
| 80541 | 1-Universal joint | | |
| 807420.6 | 1-Spark plug socket 20.6 mm (13/16") | | |

24pc Socket set

| 4246SB-5 | | | |
|------------------|---|---------------|-----|
| Part no. | Socket | 4/16/17/0.87' | 4kg |
| Content: 1/2"DR. | | | |
| 545 1.4...1.1.4 | 18-6pt. Flank socket set 1/4"; 5/16; 3/8"; 7/16"; 1/2"; 9/16"; 5/8"; 11/16"; 3/4"; 25/32"; 13/16"; 7/8"; 15/16"; 1"; 1-1/16"; 1-1/8"; 1-3/16"; 1-1/4" | | |
| 80243 | 1-Ratchet handle | | |
| 8034250 | 1-Sliding T handle | | |
| 8044 125...250 | 1-Extension bar 5"; 10" | | |
| 80541 | 1-Universal joint | | |
| 807420.6 | 1-Spark plug socket 20.6mm (13/16") | | |

24pc Socket set

| 4246SB-9 | | | |
|------------------|--|---------------|-----|
| Part no. | Socket | 4/16/17/0.87' | 4kg |
| Content: 1/2"DR. | | | |
| 549 1.4...1.1.4 | 18-12pt. Flank socket set 1/4"; 5/16; 3/8"; 7/16"; 1/2"; 9/16"; 5/8"; 11/16"; 3/4"; 25/32"; 13/16"; 7/8"; 15/16"; 1"; 1-1/16"; 1-1/8"; 1-3/16"; 1-1/4" | | |
| 80243 | 1-Ratchet handle | | |
| 8034250 | 1-Sliding T handle | | |
| 8044 125...250 | 1-Extension bar 5"; 10" | | |
| 80541 | 1-Universal joint | | |
| 807420.6 | 1-Spark plug socket 20.6mm (13/16") | | |



25pc Star set

| 4252 | | | |
|------------------|---|-----------------|-------|
| Part no. | Bit | 15/18.0/19.0/1' | 1200g |
| Content: 1/2"DR. | | | |
| 32632 08...30 | 7-1/4"DR. Star socket bit (32mmL) T8; T10; T15; T20; T25; T27; T30 | | |
| 346055 40...60 | 5-1/2"DR. Star socket bit (55mmL) T40; T45; T50; T55; T60 | | |
| 10-Star socket | | | |
| 526 04...08 | 1/4"DR.: E4; E5; E6; E7; E8 | | |
| 546 10...18 | 1/2"DR.: E10; E11; E12; E14; E18 | | |
| 766 06...10 | 3-Star key T6; T8; T10 | | |

NEW



25pc Socket set

| 4255 | | | |
|------------------|---|-------------------|-------|
| Part no. | Socket | 4/22.8/23.8/0.91' | 5700g |
| Content: 1/2"DR. | | | |
| 545 10...32 | 18-6pt. Flank socket 10; 11; 12; 13; 14; 15; 16; 17; 18; 19; 20; 21; 22; 23; 24; 27; 30; 32mm | | |
| 8334300 | 1-Adjustable handle (turn-lock design) | | |
| 802433 | 1-Ratchet handle | | |
| 803A4300 | 1-Sliding T bar | | |
| 815A4315 | 1-105° L handle 315mmL | | |
| 8044 125...250 | 2-Extension bar 5" & 10" | | |
| 80541 | 1-Universal joint | | |

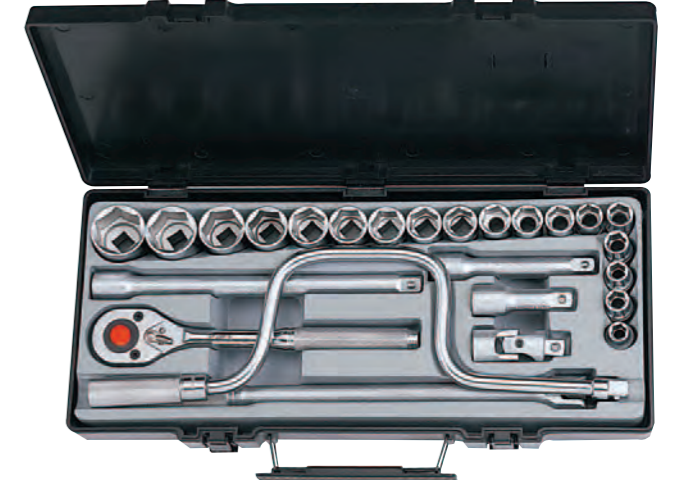

26pc Socket set

| 4262 | | | |
|------------------|--|------------------|-------|
| Part no. | Bit | 4/22.4/23.4/0.9' | 5600g |
| Content: 1/2"DR. | | | |
| 545 10...32 | 18-6pt. Flank socket 10; 11; 12; 13; 14; 15; 16; 17; 18; 19; 20; 21; 22; 23; 24; 27; 30; 32 mm | | |
| 80244 | 1-Ratchet handle | | |
| 8014380 | 1-Swivel handle 15" | | |
| 8044 075...250 | 3-Extension bar 3"; 5"; 10" | | |
| 80541 | 1-Universal joint | | |
| 8154410A | 1-Speed handle | | |
| 4262-7 | | | |
| Part no. | Bit | 4/22.4/23.4/0.9' | 5600g |
| Content: 1/2"DR. | | | |
| 547 10...32 | 18-Surface drive socket 10; 11; 12; 13; 14; 15; 16; 17; 18; 19; 20; 21; 22; 23; 24; 27; 30; 32 mm | | |
| 4262-9 | | | |
| Part no. | Bit | 4/22.4/23.4/0.9' | 5600g |
| Content: 1/2"DR. | | | |
| 549 10...32 | 18-12pt. Flank socket 10; 11; 12; 13; 14; 15; 16; 17; 18; 19; 20; 21; 22; 23; 24; 27; 30; 32 mm | | |



27pc Socket set

| | | |
|------------------------------|--|-------|
| 4281 | | |
| Part no. | 6/21.0/22.0/0.9' | 3500g |
| Content: 3/8" & 1/2"DR. | | |
| 11-1/2"DR. Hex socket bit | | |
| 344055 04...12 | 4; 5; 6; 7; 8; 10; 12 mm (55mmL) | |
| 34406514 | 14mm (65mmL) | |
| 34407017 | 17mm (70mmL) | |
| 34408008 | 8mm (80mmL) | |
| 34414010 | 10mm (140mmL) | |
| 10-1/2"DR. Spline socket bit | | |
| 348055 05...16 | M5; M6; M8; M10; M12; M14; M16 (55mmL) | |
| 348110 10...12 | M10; M12 (110mmL) | |
| 34812005 | M8 (120mmL) | |
| 6-3/8"DR. Hex socket bit | | |
| 334050 04...10 | 4; 5; 6; 7; 8; 10 mm (50mmL) | |



28pc 10mm Bit set

| | | |
|-----------------------------------|----------------------------------|-------|
| 4283 | | |
| Part no. | 15/18.0/19.0/1' | 1200g |
| Content: 3/8" & 1/2"DR. | | |
| 11-10mm Hex bit | | |
| 17430 04...12 | 4; 5; 6; 7; 8; 10; 12 mm (30mmL) | |
| 17475 05...10 | 5; 6; 8; 10 mm (75mmL) | |
| 8-10mm Spline bit | | |
| 17830 05...10 | M5; M6; M8; M10 (30mmL) | |
| 17875 06...12 | M6; M8; M10; M12 (75mmL) | |
| 17630 20...55 | 7-10mm Star bit (30mmL) | |
| T20; T25; T30; T40; T45; T50; T55 | | |
| 810 37...47 | 2-Bit holder | |
| 3/8"DR.x10mm; 1/2"DR.x10mm | | |



28pc Combination set

| | | |
|------------------|---|-------|
| 4291 | | |
| Part no. | Socket 4/19.7/20.7/0.9' | 4925g |
| Content: 1/2"DR. | | |
| 549 10...32 | 12-12pt. Flank socket | |
| | 10; 11; 12; 13; 14; 15; 17; 19; 22; 24; 30; 32 mm | |
| 54977 12...17 | 3-12pt. Flank deep socket | |
| | 12; 13; 17 mm (77mmL) | |
| 346055 20...50 | 6-Star socket bit (55mmL) | |
| | T20; T25; T30; T40; T45; T50 | |
| 8074 16...20.6 | 2-Spark plug socket 16; 20.6mm | |
| 80242 | 1-Ratchet handle | |
| 8044 125...250 | 2-Extension bar 5"; 10" | |
| 80541 | 1-Universal joint | |
| 80634 | 1-Adaptor for extension | |
| | 3/8"(F)x1/2"(M) | |

| | | |
|------------------|---|-------|
| 4291-5 | | |
| Part no. | Socket 4/19.7/20.7/0.9' | 4925g |
| Content: 1/2"DR. | | |
| 545 10...32 | 12-6pt. Flank socket | |
| | 10; 11; 12; 13; 14; 15; 17; 19; 22; 24; 30; 32 mm | |
| 54577 12...17 | 3-6pt. Flank deep socket | |
| | 12; 13; 17 mm (77mmL) | |

| | | |
|------------------|---|-------|
| 4291-7 | | |
| Part no. | Socket 4/19.7/20.7/0.9' | 4925g |
| Content: 1/2"DR. | | |
| 547 10...32 | 12-Surface drive socket | |
| | 10; 11; 12; 13; 14; 15; 17; 19; 22; 24; 30; 32 mm | |
| 54777 12...17 | 3-Surface drive deep socket | |
| | 12; 13; 17 mm (77mmL) | |

NEW



31pc 1/2"DR. 6pt. Socket & combination wrench set (S&M)

| | | |
|----------------------|--|-------|
| 4312 | | |
| Part no. | Socket 4/15.2/16.2/0.85' | 3.8kg |
| Contents: 1/2"DR. | | |
| 16-6pt. Flank socket | | |
| | 10; 12; 13; 14; 15; 16; 17; 18; 19mm | |
| | 3/8"; 7/16"; 1/2"; 9/16"; 5/8"; 11/16"; 3/4" | |
| 80244 | 1-Ratchet handle | |
| 8044 125...250 | 2-Extension 5"; 10" | |
| 80541 | 1-Universal joint | |
| 80634 | 1-Adaptor for Extension 3/8"(F) x 1/2"(M) | |
| 8074 16...20.6 | 2-Spark plug socket 16mm(5/8"); 20.6mm(13/16") | |
| 755 08...19 | 8-Combination wrench 8; 10; 11; 12; 13; 14; 17; 19mm | |



32pc Socket set

| | | | |
|-----------------|---|------------------|-------|
| 4321 | | | |
| Part no. | Socket | 4/22.2/23.2/0.9' | 5550g |
| 545 08...32 | Content: 1/2"DR. 20-6pt. Flank socket 8; 9; 10; 11; 12; 13; 14; 15; 16; 17; 18; 19; 20; 21; 22; 23; 24; 26; 27; 32 mm | | |
| 545 3.8...11.16 | 4-6pt. Flank socket 3/8"; 1/2"; 9/16"; 11/16" | | |
| 802411 | 1-Ratchet handle | | |
| 8014380 | 1-Swivel handle 15" | | |
| 8044 075...250 | 3-Extension bar 3"; 5"; 10" | | |
| 8074 16...20.6 | 2-Spark plug socket 16; 20.6 mm | | |
| 80541 | 1-Universal joint | | |

| | | | |
|-----------------|--|------------------|-------|
| 4321-7 | | | |
| Part no. | Socket | 4/22.2/23.2/0.9' | 5550g |
| Changed Items | Content: 1/2"DR. | | |
| 547 08...32 | 20-Surface drive socket 8; 9; 10; 11; 12; 13; 14; 15; 16; 17; 18; 19; 20; 21; 22; 23; 24; 26; 27; 32 mm | | |
| 547 3.8...11.16 | 4-Surface drive socket 3/8"; 1/2"; 9/16"; 11/16" | | |

NEW



32pc 1/2"DR. Socket combination & wrench set

| | | | |
|----------------|---|------------------|-------|
| 4324 | | | |
| Part no. | Socket | 4/20.7/21.7/1.3' | 5175g |
| 545 08...32 | Content: 1/2"DR. 15-6pt. Flank socket 8; 10; 12; 13; 14; 15; 16; 17; 18; 19; 22; 24; 27; 30; 32 mm | | |
| 80243 | 1-Ratchet handle | | |
| 8034250 | 1-Sliding T handle 10"(250mmL) | | |
| 8044 125...250 | 2-Extension 5"; 10" | | |
| 80541 | 1-Universal joint | | |
| 8074 16...20.6 | 2-Spark plug socket 16; 20.6mm | | |
| 755 10... 22 | 10-Combination wrench 10; 12; 13; 14; 15; 16; 17; 18; 19; 22 mm | | |

NEW



32pc 1/2"DR. 6pt. Socket & wrench combination set (SAE)

| | | | |
|------------------|--|------------------|-------|
| 4325 | | | |
| Part no. | Socket | 4/19.6/20.6/1.2' | 4900g |
| 545 5.16...1.1.4 | Content: 1/2"DR. 15-6pt. Flank socket 5/16"; 3/8"; 7/16"; 1/2"; 9/16"; 19/32"; 5/8"; 11/16"; 3/4"; 25/32"; 13/16"; 15/16"; 1-1/16"; 1-1/8"; 1-1/4" | | |
| 80243 | 1-Ratchet handle | | |
| 8034250 | 1-Sliding T handle 10" | | |
| 8044 125...250 | 2-Extension 5"; 10" | | |
| 80541 | 1-Universal joint | | |
| 8074 16...20.6 | 2-Spark plug socket 16 mm (5/8"); 20.6mm(13/16") | | |
| 755 1.4...13.16 | 10-Combination wrench 1/4"; 5/16"; 3/8"; 7/16"; 1/2"; 9/16"; 5/8"; 11/16"; 3/4"; 13/16" | | |



35pc Bit set

| | | |
|---------------|---|-------|
| 4351 | | |
| Part no. | 10/22.5/23.5/0.7' | 2500g |
| 17430 04...12 | Content: 3/8" & 1/2"DR. 14-10mm Hex bit 4; 5; 6; 7; 8; 10; 12 (30mmL) | |
| 17475 04...10 | 4; 5; 6; 7; 8; 10; 12 (75mmL) | |
| 17630 20...55 | 14-10mm Star bit T20; T25; T30; T40; T45; T50; T55 (30mmL) | |
| 17675 20...55 | T20; T25; T30; T40; T45; T50; T55 (75mmL) | |
| 19650 60...70 | 4-14mm Star bit T60; T70 (50mmL) | |
| 19675 60...70 | T60; T70 (75mmL) | |
| 810 37...414 | 3-Bit holder 3/8"DR.x10mm; 1/2"DR.x10mm; 1/2"DR.x14mm | |



35pc Star set

| Part no. | Bit | 15/21.3/22.3/1' | 1420g |
|---------------|--|-----------------|-------|
| 1263009 | 1-1/4" Star bit T9 (30mmL) | | |
| 12730 10...20 | 3-1/4" Star tamperproof bit T-10H; T-15H; T-20H (30mmL) | | |
| 17675 25...55 | 7-10mm Star bit (75mmL) T25; T27; T30; T40; T45; T50; T55 | | |
| 17730 25...50 | 6-10mm Star tamperproof bit T-25H; T-27H; T-30H; T-40H; T-45H; T-50H (30mmL) | | |
| 19675 60...70 | 2-14mm Star bit T60; T70 (75mmL) | | |
| 526 04...08 | 3-1/4"DR. Star socket E4; E5; E6; E7; E8 | | |
| 536 10...20 | 7-3/8"DR. Star socket E10; E11; E12; E14; E16; E18; E20 | | |
| 810 22...414 | 4-Bit holder 1/4"DR.x1/4"; 3/8"DR.x10mm; 1/2"DR.x10mm; 1/2"DR.x14mm | | |



40pc Bit set

| Part no. | Bit | 10/20.0/21.0/0.8' | 2000g |
|---------------|---|-------------------|-------|
| 17430 04...12 | 4; 5; 6; 7; 8; 10; 12 mm (30mmL) | | |
| 17475 04...12 | 4; 5; 6; 7; 8; 10; 12 mm (75mmL) | | |
| 17630 20...55 | 14-10mm Star bit T20; T25; T30; T40; T45; T50; T55 (30mmL) | | |
| 17675 20...55 | T20; T25; T30; T40; T45; T50; T55 (75mmL) | | |
| 17830 05...12 | 10-10mm Spline bit M5; M6; M8; M10; M12 (30mmL) | | |
| 17875 05...12 | M5; M6; M8; M10; M12 (75mmL) | | |
| 810 37...47 | 2-Bit holder 3/8"DR.x10mm; 1/2"DR.x10mm | | |
| 4401T | | | |
| Part no. | Bit | 10/20.0/21.0/0.8' | 2000g |
| 17730 20...55 | Content: 3/8" & 1/2"DR. 14-10mm Star bit T-20H; T-25H; T-30H; T-40H; T-45H; T-50H; T-55H (30mmL) | | |
| 17775 20...55 | T-20H; T-25H; T-30H; T-40H; T-45H; T-50H; T-55H (75mmL) | | |



40pc Bit set

| Part no. | Bit | 10/19.0/20.0/1' | 1900g |
|---------------|--|-----------------|-------|
| 17430 04...12 | Content: 1/2"DR. 14-10mm Hex bit 4; 5; 6; 7; 8; 10; 12 mm (30mmL) | | |
| 17475 04...12 | 4; 5; 6; 7; 8; 10; 12 mm (75mmL) | | |
| 17630 20...55 | 14-10mm Star bit T20; T25; T30; T40; T45; T50; T55 (30mmL) | | |
| 17675 20...55 | T20; T25; T30; T40; T45; T50; T55 (75mmL) | | |
| 17830 05...12 | 10-10mm Spline bit M5; M6; M8; M10; M12 (30mmL) | | |
| 17875 05...12 | M5; M6; M8; M10; M12 (75mmL) | | |
| 810 37...47 | 2-Bit holder 3/8"DR.x10mm; 1/2"DR.x10mm | | |
| 4401CT | | | |
| Part no. | Bit | 10/19.0/20.0/1' | 1900g |
| 17730 20...55 | Content: 1/2"DR. 14-10mm Star tamperproof bit T-20H; T-25H; T-30H; T-40H; T-45H; T-50H; T-55H (30mmL) | | |
| 17775 20...55 | T-20H; T-25H; T-30H; T-40H; T-45H; T-50H; T-55H (75mmL) | | |



40pc Combination set

| Part no. | Socket | 4/22.1/23.1/0.9' | 5530g |
|----------------|---|------------------|-------|
| 545 08...32 | Content: 3/8" & 1/2"DR. 19-6pt. Flank socket 8; 10; 11; 12; 13; 14; 15; 16; 17; 18; 19; 20; 21; 22; 23; 24; 27; 30; 32 mm | | |
| 54577 12...17 | 4-6pt. Flank deep socket 12; 13; 15; 17 mm | | |
| 344055 06...12 | 9-Socket bit (55mmL) Hex 6; 8; 10; 12 mm | | |
| 346055 30...55 | Star T30; T40; T45; T50; T55 | | |
| 80249 | 1-72 teeth ratchet handle | | |
| 8044 125...250 | 1-Extension bar 5"; 10" | | |
| 80541 | 1-Universal joint | | |
| 80634 | 1-Adaptor for extension 3/8"(F)x1/2"(M) | | |
| 8074 16...20.6 | 3-Spark plug socket 16mm; 18mm; 20.6mm | | |



41pc Star set

| 4411 | | | |
|--------------------------------|--|------------------|-------|
| Part no. | Bit | 6/14.8/15.8/0.9' | 2466g |
| Content: 1/4" & 3/8" & 1/2"DR. | | | |
| 766 09...70 | 13-Star L key T9; T10; T15; T20; T25; T27; T30; T40; T45; T50; T55; T60; T70 | | |
| 12630 09...20 | 4-1/4" Star bit (30mmL) T9; T10; T15; T20 | | |
| 17630 25...50 | 6-10mm Star bit (30mmL) T25; T27; T30; T40; T45; T50 | | |
| 17611555 | 1-10mm Star bit T55 (115mmL) | | |
| 19675 60...70 | 2-14mm Star bit (75mmL) T60; T70 | | |
| 526 04...08 | 5-1/4"DR. Star socket E4; E5; E6; E7; E8 | | |
| 536 10...20 | 7-3/8"DR. Star socket E10; E11; E12; E14; E16; E18; E20 | | |
| 810 22...414 | 3-Bit holder 1/4"DR.x1/4"; 3/8"DR.x10mm; 1/2"DR.x14mm | | |



41pc Socket set

| 4412 | | | |
|------------------|--|------------------|-------|
| Part no. | Socket | 4/26.6/27.6/0.9' | 6650g |
| Content: 1/2"DR. | | | |
| 549 10...32 | 33-12pt. Flank Socket 10; 11; 12; 13; 14; 15; 16; 17; 18; 19; 20; 21; 22; 23; 24; 27; 30; 32 mm | | |
| 549 3.8...1.1.4 | 3/8"; 7/16"; 1/2"; 9/16"; 5/8"; 11/16"; 3/4"; 13/16"; 7/8"; 15/16"; 1"; 1-1/16"; 1-1/8"; 1-3/16"; 1-1/4" | | |
| 80242 | 1-Ratchet handle | | |
| 8044 125...250 | 2-Extension bar 5"; 10" | | |
| 8074 16...20.6 | 2-Spark plug socket 16; 20.6 mm | | |
| 8034250 | 1-Sliding T handle | | |
| 80541 | 1-Universal joint | | |
| 8154410A | 1-Speed handle | | |
| 4412-5 | | | |
| Part no. | Socket | 4/26.6/27.6/0.9' | 6650g |
| Content: 1/2"DR. | | | |
| 545 10...32 | 33-6pt. Flank socket 10; 11; 12; 13; 14; 15; 16; 17; 18; 19; 20; 21; 22; 23; 24; 27; 30; 32 mm | | |
| 545 3.8...1.1.4 | 3/8"; 7/16"; 1/2"; 9/16"; 5/8"; 11/16"; 3/4"; 13/16"; 7/8"; 15/16"; 1"; 1-1/16"; 1-1/8"; 1-3/16"; 1-1/4" | | |



42pc Bit set

| 4421 | | |
|------------------------------|--|------------------|
| Part no. | 10/21.0/22.0/0.8' | 2100g |
| Content: 3/8" & 1/2"DR. | | |
| 14-10mm Hex bit | | |
| 17430 04...12 | 4; 5; 6; 7; 8; 10; 12 mm (30mmL) | |
| 17475 04...12 | 4; 5; 6; 7; 8; 10; 12 mm (75mmL) | |
| 16-10mm Star bit | | |
| 17630 20...60 | T20; T25; T30; T40; T45; T50; T55; T60 (30mmL) | |
| 17675 20...60 | T20; T25; T30; T40; T45; T50; T55; T60 (75mmL) | |
| 10-10mm Spline bit | | |
| 17830 05...12 | M5; M6; M8; M10; M12 (30mmL) | |
| 17875 05...12 | M5; M6; M8; M10; M12 (75mmL) | |
| 810 37...47 | 2-Bit holder 3/8"DR.x10mm; 1/2"DR.x10mm | |
| 4421T | | |
| Part no. | Socket | 4/26.6/27.6/0.8' |
| Content: 3/8" & 1/2"DR. | | |
| 16-10mm Star tamperproof bit | | |
| 17730 20...60 | T-20H; T-25H; T-30H; T-40H; T-45H; T-50H; T-55H; T-60H (30mmL) | |
| 17775 20...60 | T-20H; T-25H; T-30H; T-40H; T-45H; T-50H; T-55H; T-60H (75mmL) | |



42pc Bit set

| 4421C | | |
|------------------------------|--|-----------------|
| Part no. | 10/20.0/21.0/1' | 2000g |
| Content: 3/8" & 1/2"DR. | | |
| 14-10mm Hex bit | | |
| 17430 04...12 | 4; 5; 6; 7; 8; 10; 12 mm (30mmL) | |
| 17475 04...12 | 5; 6; 7; 8; 10; 12 mm (75mmL) | |
| 16-10mm Star bit | | |
| 17630 20...60 | T20; T25; T30; T40; T45; T50; T55; T60 (30mmL) | |
| 17675 20...60 | T20; T25; T30; T40; T45; T50; T55; T60 (75mmL) | |
| 10-10mm Spline bit | | |
| 17830 05...12 | M5; M6; M8; M10; M12 (30mmL) | |
| 17875 05...12 | M5; M6; M8; M10; M12 (75mmL) | |
| 810 37...47 | 2-Bit holder 3/8"DR.x10mm; 1/2"DR.x10mm | |
| 4421CT | | |
| Part no. | Bit | 10/20.0/21.0/1' |
| Content: 3/8" & 1/2"DR. | | |
| 16-10mm Star tamperproof bit | | |
| 17730 20...60 | T-20H; T-25H; T-30H; T-40H; T-45H; T-50H; T-55H; T-60H (30mmL) | |
| 17775 20...60 | T-20H; T-25H; T-30H; T-40H; T-45H; T-50H; T-55H; T-60H (75mmL) | |



42pc 1/2" Spline socket set

| 4422Q | | | |
|------------------|--|------------------|-------|
| Part no. | Socket | 4/19.5/20.5/0.9" | 4875g |
| Content: 1/2"DR. | | | |
| 54Q 10...32 | 17-Spline socket 10; 11; 12; 13; 14; 15; 16; 17; 18; 19; 20; 21; 22; 24; 27; 30; 32 mm | | |
| 80242 | 1-Ratchet handle | | |
| 80541 | 1-Universal Joint | | |
| 80634 | 1-Adaptor for Extension | | |
| 8044 125...250 | 2-Extension bar 125-5"; 250-10" | | |
| 81047 | 1-Bit holder | | |
| 17830 05...12 | 5-Spline bit M5; M6; M8; M10; M12 | | |
| 17430 05...12 | 6-Hex bit H5; H6; H7; H8; H10; H12 | | |
| 17630 20...55 | 8-Torx bit T20; T25; T27; T30; T40; T45; T50; T55 | | |

44pc Bit set

| 4441C | | |
|-------------------------|---|-------|
| Part no. | 10/22.5/23.5/1" | 2250g |
| Content: 3/8" & 1/2"DR. | | |
| 17430 04...12 | 14-10mm Hex bit 4; 5; 6; 7; 8; 10; 12 mm (30mmL) | |
| 17475 04...12 | 4; 5; 6; 7; 8; 10; 12 mm (75mmL) | |
| 17630 20...60 | 16-10mm Star bit T20; T25; T30; T40; T45; T50; T55; T60 (30mmL) | |
| 17675 20...60 | T20; T25; T30; T40; T45; T50; T55; T60 (75mmL) | |
| 17830 05...12 | 10-10mm Spline bit M5; M6; M8; M10; M12 (30mmL) | |
| 17875 05...12 | M5; M6; M8; M10; M12 (75mmL) | |
| 34610070 | 1-Star socket bit T70 (100mmL) | |
| 34607080 | 1-Star socket bit T80 (70mmL) | |
| 810 37...47 | 2-Bit holder 3/8"DR.x10mm; 1/2"DR.x10mm | |

4441CT

| 4441CT | | | |
|-------------------------|--|-----------------|-------|
| Part no. | Bit | 10/22.5/23.5/1" | 2250g |
| Content: 3/8" & 1/2"DR. | | | |
| 17730 20...60 | 16-10mm Star tamperproof bit T-20H; T-25H; T-30H; T-40H; T-45H; T-50H; T-55H; T-60H (30mmL) | | |
| 17775 20...60 | T-20H; T-25H; T-30H; T-40H; T-45H; T-50H; T-55H; T-60H (75mmL) | | |
| 34710070 | 1-Star tamperproof socket bit T-70H (100mmL) | | |
| 34707080 | 1-Star tamperproof socket bit T-80H (70mmL) | | |

44pc Bit set

| 4442C | | |
|-------------------------|---|-------|
| Part no. | 10/22.0/23.0/1" | 2200g |
| Content: 3/8" & 1/2"DR. | | |
| 17430 04...12 | 14-10mm Hex bit 4; 5; 6; 7; 8; 10; 12 mm (30mmL) | |
| 17475 04...12 | 4; 5; 6; 7; 8; 10; 12 mm (75mmL) | |
| 17630 20...60 | 16-10mm Star bit T20; T25; T30; T40; T45; T50; T55; T60 (30mmL) | |
| 17675 20...60 | T20; T25; T30; T40; T45; T50; T55; T60 (75mmL) | |
| 17830 05...12 | 10-10mm Spline bit M5; M6; M8; M10; M12 (30mmL) | |
| 17875 05...12 | M5; M6; M8; M10; M12 (75mmL) | |
| 34610070 | 1-Star socket bit T70 (100mmL) | |
| 34614055 | 1-Star socket bit T55 (140mmL) | |
| 810 37...47 | 2-Bit holder 3/8"DR.x10mm; 1/2"DR.x10mm | |

4442CT

| 4442CT | | | |
|-------------------------|--|-----------------|-------|
| Part no. | Bit | 10/22.0/23.0/1" | 2200g |
| Content: 3/8" & 1/2"DR. | | | |
| 17730 20...60 | 16-10mm Star tamperproof bit T-20H; T-25H; T-30H; T-40H; T-45H; T-50H; T-55H; T-60H (30mmL) | | |
| 17775 20...60 | T-20H; T-25H; T-30H; T-40H; T-45H; T-50H; T-55H; T-60H (75mmL) | | |

51pc Combination set

| 4511 | | | |
|-------------------------|--|----------------|-------|
| Part no. | Socket | 3/17.3/18.3/1" | 5760g |
| Content: 1/4" & 1/2"DR. | | | |
| 529 04...13 | 1/4"DR. Part: 11-12pt. Flank socket 4; 4.5; 5; 6; 7; 8; 9; 10; 11; 12; 13 mm | | |
| 32432 03...06 | 10-Socket bit (32mmL) Hex 3; 4; 5; 6 mm | | |
| 32332 04...07 | Slotted 4; 5.5; 7 mm | | |
| 32132 1...3 | Phillips PH.1; PH.2; PH.3 | | |
| 80222 | 1-Ratchet handle | | |
| 8042 050...100 | 2-Extension bar 2"; 4" | | |
| 8032115 | 1-Sliding T handle | | |
| 80521 | 1-Universal joint | | |
| 8143 | 1-Spinner | | |
| 549 10...30 | 1/2"DR. Part: 12-12pt. Flank socket 10; 11; 12; 13; 14; 15; 17; 19; 22; 24; 27; 30 mm | | |
| 344055 07...12 | 5-Hex socket bit 7; 8; 10; 12 mm (55mmL) | | |
| 34406514 | 14 mm (65mmL) | | |
| 343055 08...10 | 2-Slotted socket bit 1.2x8; 1.6x10 mm (55mmL) | | |
| 341554 | 1-Phillips socket bit PH.4 (55mmL) | | |
| 80242 | 1-Ratchet handle | | |
| 8044125 | 2-Extension bar 5" | | |
| 808410 | Locking extension 10" | | |
| 80541 | 1-Universal joint | | |



| | | | |
|---------------|---|----------------|-------|
| 4511-5 | | | |
| Part no. | Socket | 3/17.3/18.3/1' | 5760g |
| Changed Items | Content: 1/4" & 1/2"DR. 1/4"DR. Part: | | |
| 525 04...13 | 11-6pt. Flank socket 4; 4.5; 5; 6; 7; 8; 9; 10; 11; 12; 13 mm | | |
| 545 10...30 | 1/2"DR. Part: 12-6pt. Flank socket 10; 11; 12; 13; 14; 15; 17; 19; 22; 24; 27; 30 mm | | |

| | | | |
|---------------|--|----------------|-------|
| 4511-7 | | | |
| Part no. | Socket | 3/17.3/18.3/1' | 5760g |
| Changed Items | Content: 1/4" & 1/2"DR. 1/4"DR. Part: | | |
| 527 04...13 | 11-Surface drive socket 4; 4.5; 5; 6; 7; 8; 9; 10; 11; 12; 13 mm | | |
| 547 10...30 | 1/2"DR. Part: 12-Surface drive socket 10; 11; 12; 13; 14; 15; 17; 19; 22; 24; 27; 30 mm | | |



51pc Combination set

| | | | |
|-----------------|---|----------------|-------|
| 4512 | | | |
| Part no. | Socket | 3/16.8/17.8/1' | 5600g |
| 547 10...32 | Content: 1/2"DR. 15-Surface drive socket 10; 11; 12; 13; 14; 15; 16; 17; 18; 19; 22; 24; 27; 30; 32 mm | | |
| 80242 | 1-Ratchet handle | | |
| 8044 125...250 | 2-Extension bar 5"; 10" | | |
| 8074 16...20.6 | 2-Spark plug socket 16; 20.6 mm | | |
| 80541 | 1-Universal joint | | |
| 80634 | 1-Adaptor for extension 3/8"(F)x1/2"(M) | | |
| 755 08...22 | 9-Combination wrench 8; 10; 11; 12; 13; 14; 17; 19; 22 mm | | |
| 5102A | 10pc Hex key set 1.27; 1.5; 2; 2.5; 3; 4; 5; 6; 8; 10 mm | | |
| 764 0127A...10A | 10pc Hex extra long ball key set 1.27; 1.5; 2; 2.5; 3; 4; 5; 6; 8; 10 mm | | |

| | | | |
|---------------|--|----------------|-------|
| 4512-5 | | | |
| Part no. | Socket | 3/16.8/17.8/1' | 5600g |
| Changed Items | Content: 1/2"DR. | | |
| 545 10...32 | 15-6pt. Flank socket 10; 11; 12; 13; 14; 15; 16; 17; 18; 19; 22; 24; 27; 30; 32 mm | | |

| | | | |
|---------------|---|----------------|-------|
| 4512-9 | | | |
| Part no. | Socket | 3/16.8/17.8/1' | 5600g |
| Changed Items | Content: 1/2"DR. | | |
| 549 10...32 | 15-12pt. Flank socket 10; 11; 12; 13; 14; 15; 16; 17; 18; 19; 22; 24; 27; 30; 32 mm | | |



53pc Combination set

| | | | |
|----------------|--|------------------|-------|
| 4541 | | | |
| Part no. | Socket | 4/20.0/21.0/0.9' | 5000g |
| 529 04...11 | Content: 1/4" & 1/2"DR. 1/4"DR. Part: 9-12pt. Flank socket 4; 5; 5.5; 6; 7; 8; 9; 10; 11 mm 16-Socket bit (32mmL) Hex 3; 4; 5; 6 mm Star T10; T20; T25; T27; T30; T40 Slotted 4; 5.5; 7 mm PH.1; PH.2; PH.3 | | |
| 80222 | 1-Ratchet handle | | |
| 8042 050...150 | 2-Extension bar 2"; 6" | | |
| 80521 | 1-Universal joint | | |
| 8142 | 1-Spinner | | |
| 764 0127...025 | 4-Hex key 1.27; 1.5; 2; 2.5 mm | | |
| 549 10...32 | 1/2"DR. Part: 12-12pt. Flank socket 10; 11; 12; 13; 14; 15; 17; 20; 22; 24; 30; 32 mm | | |
| 80242 | 1-Ratchet handle | | |
| 8044 125...250 | 2-Extension bar 5"; 10" | | |
| 8074 16...20.6 | 2-Spark plug socket 16 ; 20.6mm | | |
| 80541 | 1-Universal joint | | |
| 80634 | 1-Adaptor for extension 3/8"(F)x1/2"(M) | | |

| | | | |
|---------------|---|------------------|-------|
| 4541-5 | | | |
| Part no. | Socket | 4/20.0/21.0/0.9' | 5000g |
| Changed Items | Content: 1/4" & 1/2"DR. 1/4"DR. Part: | | |
| 525 04...11 | 9-6pt. Flank socket 4; 5; 5.5; 6; 7; 8; 9; 10; 11 mm | | |
| 545 10...32 | 1/2"DR. Part: 12-6pt. Flank socket 10; 11; 12; 13; 14; 15; 17; 20; 22; 24; 30; 32 mm | | |

| | | | |
|---------------|--|------------------|-------|
| 4541-7 | | | |
| Part no. | Socket | 4/20.0/21.0/0.9' | 5000g |
| Changed Items | Content: 1/4" & 1/2"DR. 1/4"DR. Part: | | |
| 527 04...11 | 9-Surface drive socket 4; 5; 5.5; 6; 7; 8; 9; 10; 11 mm | | |
| 547 10...32 | 1/2"DR. Part: 12-Surface drive socket 10; 11; 12; 13; 14; 15; 17; 20; 22; 24; 30; 32 mm | | |

NEW



58pc 1/4" & 1/2" DR. Combination set

| | | | |
|---------------|---|------------------|-------|
| 4582 | | | |
| Part no. | Socket | 4/20.0/21.0/0.9' | 5000g |
| 12125 1...3 | Content: 1/4" DR. & 1/2" DR. 1/4" DR. part: | | |
| 12225 1...3 | 17-Bit (25mmL) Phillips PH.1; PH.2; PH.3 Pozi driv PH.1; PZ.2; PZ.3 | | |
| 12325 04...08 | Slotted 4; 5.5; 6.5; 8 mm | | |
| 12625 10...40 | Star T10; T15; T20; T25; T27; T30; T40 | | |
| 81022M | 1-Magnetic bit Holder 1/4"(F)x1/4"(F) | | |
| 8032115 | 1-Sliding T handle 115mmL | | |
| 8143 | 1-Spinner | | |
| 545 08...32 | 1/2" DR. part: 16-6pt. Flank socket 8; 10; 11; 12; 13; 14; 16; 17; 18; 19; 21; 22; 24; 27; 30; 32 mm | | |
| 802424 | 1-Quick-release 72th round ratchet handle | | |
| 8044100 | 1-Extension 100mmL | | |
| 80541 | 1-Universal joint | | |
| 755 08...19 | Other: 9-Combination wrench 8; 10; 11; 12; 13; 16; 17; 18; 19 mm | | |
| 5102 | 10-Hex short key 1.27; 1.5; 2; 2.5; 3; 4; 5; 6; 8; 10 mm | | |

| | | | |
|----------------|---|----------------|-------|
| 4582-15 | | | |
| Part no. | Socket | 3/17.0/18.0/1' | 5660g |
| 802415 | Content: 1/4" DR. & 1/2" DR. 1-Ratchet handle 36 teeth | | |



60pc Combination set

| 4601 | | | |
|----------------|--|----------------|-------|
| Part no. | Socket | 3/17.0/18.0/1' | 5660g |
| 547 10...32 | Content: 1/2"DR. 17-Surface driver socket 10; 11; 12; 13; 14; 15; 16; 17; 18; 19; 20; 21; 22; 24; 27; 30; 32 mm | | |
| 54777 10...22 | 9-Surface driver deep socket (77mmL) 26-10; 11; 12; 13; 14; 15; 17; 19; 22 mm | | |
| 15430 04...14 | 5/16" bit (30mmL) | | |
| 15630 20...55 | Hex 4; 5; 6; 8; 10; 12; 14 mm Star T20; T25; T27; T30; T40; T45; T50; T55 | | |
| 15330 08...12 | Slotted 8; 10; 12 mm | | |
| 15130 1...4 | Phillips PH.1; PH.2; PH.3; PH.4 | | |
| 15230 1...4 | Pozidriv PZ.1; PZ.2; PZ.3; PZ.4 | | |
| 80242 | 1-Ratchet handle | | |
| 8074 16...20.6 | 2-Spark plug socket 16; 20.6 mm | | |
| 8044 125...250 | 2-Extension bar 5"; 10" | | |
| 80541 | 1-Universal joint | | |
| 81045 | 1-Bit holder 1/2"DR.x5/16" | | |
| 80634 | 1-Adaptor for extension 3/8"(F)x1/2"(M) | | |

| 4601-5 | | | |
|---------------|---|----------------|-------|
| Part no. | Socket | 3/17.0/18.0/1' | 5660g |
| 545 10...32 | Content: 1/2"DR. 17-6pt. Flank socket 10; 11; 12; 13; 14; 15; 16; 17; 18; 19; 20; 21; 22; 24; 27; 30; 32 mm | | |
| 54577 10...22 | 9-6pt. Flank deep socket (77mmL) 10; 11; 12; 13; 14; 15; 17; 19; 22 mm | | |
| 4601-9 | | | |
| Part no. | Socket | 3/17.0/18.0/1' | 5660g |
| 54910...32 | Content: 1/2"DR. 17-12pt. Flank socket 10; 11; 12; 13; 14; 15; 16; 17; 18; 19; 20; 21; 22; 24; 27; 30; 32 mm | | |
| 54977 10...22 | 9-12pt. Flank deep socket (77mmL) 10; 11; 12; 13; 14; 15; 17; 19; 22 mm | | |

NEW



60pc Combination set

| 4602 | | | |
|----------------|---|------------------|-------|
| Part no. | Socket | 3/17.0/18.0/1.7' | 5666g |
| 525 04...10 | Content: 1/4"DR. & 1/2"DR. 1/4"DR. 7-6pt. Flank socket 4; 5; 6; 7; 8; 9; 10 mm | | |
| 8143 | 1-Spinner | | |
| 80222 | 1-Ratchet handle 24th | | |
| 81022 | 1-Bit holder 1/4"(F)x1/4"inhex | | |
| 12330 04...065 | 3-Slotted bit 4; 5.5; 6.5 mm | | |
| 12630 10...40 | 7-Star bit T10; T15; T20; T25; T27; T30; T40 | | |
| 12130 1...3 | 3-Phillips bit PH.1; PH.2; PH.3 | | |
| 12430 03...06 | 4-Hex bit 3; 4; 5; 6 mm | | |
| 545 10...27 | 1/2"DR. 11-6pt. Flank socket 10; 11; 12; 13; 14; 15; 17; 19; 22; 24; 27 mm | | |
| 8044125 | 1-Extension bar 5" | | |
| 80541 | 1-Universal joint | | |
| 80243 | 1-24 teeth Ratchet handle | | |
| 8074 16...20.6 | 2-Spark plug socket 16; 20.6 mm | | |
| 755 11...17 | Others: 6-Combination wrench 11; 12; 13; 14; 15; 17 mm | | |
| 613B250 | 1-Waterpump pliers 10" | | |
| 611B175 | 1-Combination pliers 7" | | |
| 764 015...025 | 3-Hex key 1.5; 2; 2.5 mm | | |
| 616300 | 1-Engineer hammer 300g | | |
| 7112S | 1-Stubby Phillips screwdriver PH.2(25mmL) | | |
| 713065S | 1-Stubby slotted screwdriver 6.5mm(25mmL) | | |
| 711 1...2 | 2-Phillips screwdriver PH.1x80mmL; PH.2x100mmL | | |
| 713065 | 1-Slotted screwdriver 6.5mmx150mmL | | |



60pc Combination set

| 4611-72 | | | |
|----------------|--|----------------|-------|
| Part no. | Socket | 3/20.3/21.3/1' | 6760g |
| 529 04...10 | Content: 1/4" & 1/2"DR. 1/4"DR. Part: 8-12pt. Flank Socket 4; 5; 5.5; 6; 7; 8; 9; 10 mm | | |
| 52950 08...10 | 2-12pt. Flank deep socket 8; 10 mm (50mmL) | | |
| 32432 04...06 | 11-Socket bit (32mmL) Hex 4; 5; 6 mm | | |
| 32632 10...30 | Star T10; T20; T25; T30 | | |
| 32132 1...2 | Phillips PH.1; PH.2 | | |
| 32332 04...055 | Slotted 4; 5.5 mm | | |
| 80229 | 1-72 teeth ratchet handle | | |
| 8042 050...150 | 2-Extension bar 2"; 6" | | |
| 80521 | 1-Universal joint | | |
| 8142 | 1-Spinner | | |
| 764 0127...025 | 4-Hex key 1.27; 1.5; 2; 2.5 mm | | |
| 549 10...32 | 1/2"DR. Part: 12-12pt. Flank Socket 10; 11; 12; 13; 14; 15; 17; 19; 22; 24; 30; 32 mm | | |
| 54977 12...17 | 3-12pt. Flank deep socket 12; 13; 17 mm (77mmL) | | |
| 344100 07...10 | 3-Hex socket bit 7; 8; 10 mm (100mmL) | | |
| 346055 40...50 | 3-Star socket bit T40; T45; T50 | | |
| 341553 | 1-Phillips socket bit PH.3 | | |
| 34305508 | 1-Slotted socket bit 8 mm | | |
| 80249 | 1-72 teeth ratchet handle | | |
| 8074 16...20.6 | 2-Spark plug socket 16; 20.6 mm | | |
| 8044125 | 1-Extension bar 5" | | |
| 808410 | 1-Locking extension 10" | | |
| 8034250 | 1-Sliding T handle | | |
| 80541 | 1-Universal joint | | |



60pc Combination set

| 4611 | Socket | 3/20.3/21.3/1' | 6760g |
|-------------------------|--------------------------------|---|-------|
| Part no. | Socket | 3/20.3/21.3/1' | 6760g |
| Content: 1/4" & 1/2"DR. | | | |
| 1/4"DR. Part: | | | |
| 529 04...10 | 8-12pt. Flank Socket | 4; 5; 5.5; 6; 7; 8; 9; 10 mm | |
| 52950 08...10 | 2-12pt. Flank deep socket | 8; 10 mm (50mmL) | |
| 11-Socket bit (32mmL) | | | |
| 32432 04...06 | Hex 4; 5; 6 mm | | |
| 32632 10...30 | Star T10; T20; T25; T30 | | |
| 32132 1...2 | Phillips PH.1; PH.2 | | |
| 32332 04...055 | Slotted 4; 5.5 mm | | |
| 80222 | 1-Ratchet handle | | |
| 8042 050...150 | 2-Extension bar 2"; 6" | | |
| 80521 | 1-Universal joint | | |
| 8142 | 1-Spinner | | |
| 764 0127...025 | 4-Hex key 1.27; 1.5; 2; 2.5 mm | | |
| 1/2"DR. Part: | | | |
| 549 10...32 | 12-12pt. Flank Socket | 10; 11; 12; 13; 14; 15; 17; 19; 22; 24; 30; 32 mm | |
| 54977 12...17 | 3-12pt. Flank deep socket | 12; 13; 17 mm (77mmL) | |
| 344100 07...10 | 3-Hex socket bit | 7; 8; 10 mm (100mmL) | |

| 4611 | Socket | 3/20.3/21.3/1' | 6760g |
|----------------|---------------------------------|----------------|-------|
| Part no. | Socket | 3/20.3/21.3/1' | 6760g |
| 346055 40...50 | 3-Star socket bit T40; T45; T50 | | |
| 341553 | 1-Phillips socket bit PH.3 | | |
| 34305508 | 1-Slotted socket bit 8 mm | | |
| 80242 | 1-Ratchet handle | | |
| 8074 16...20.6 | 2-Spark plug socket 16; 20.6mm | | |
| 8044125 | 1-Extension bar 5" | | |
| 808410 | 1-Locking extension 10" | | |
| 8034250 | 1-Sliding T handle | | |
| 80541 | 1-Universal joint | | |

| 4611-5 | Socket | 3/20.3/21.3/1' | 6760g |
|-------------------------|--------------------------|---|-------|
| Part no. | Socket | 3/20.3/21.3/1' | 6760g |
| Changed Items | | | |
| Content: 1/4" & 1/2"DR. | | | |
| 1/4"DR. Part: | | | |
| 525 04...10 | 8-6pt. Flank Socket | 4; 5; 5.5; 6; 7; 8; 9; 10 mm | |
| 52550 08...10 | 2-6pt. Flank deep socket | 8; 10 mm (50mmL) | |
| 1/2"DR. Part: | | | |
| 545 10...32 | 12-6pt. Flank Socket | 10; 11; 12; 13; 14; 15; 17; 19; 22; 24; 30; 32 mm | |
| 54577 12...17 | 3-6pt. Flank deep socket | 12; 13; 17 mm (77mmL) | |

| 4611-7 | Socket | 3/20.3/21.3/1' | 6760g |
|-------------------------|-----------------------------|---|-------|
| Part no. | Socket | 3/20.3/21.3/1' | 6760g |
| Changed Items | | | |
| Content: 1/4" & 1/2"DR. | | | |
| 1/4"DR. Part: | | | |
| 527 04...10 | 8-Surface drive Socket | 4; 5; 5.5; 6; 7; 8; 9; 10 mm | |
| 52750 08...10 | 2-Surface drive deep socket | 8; 10 mm (50mmL) | |
| 1/2"DR. Part: | | | |
| 547 10...32 | 12-Surface drive Socket | 10; 11; 12; 13; 14; 15; 17; 19; 22; 24; 30; 32 mm | |
| 54777 12...17 | 3-Surface drive deep socket | 12; 13; 17 mm (77mmL) | |



64pc Socket set

| 4641 | Socket | 2/22.0/23.0/0.77' | 11kg |
|--------------------------|--------------------------------|--|------|
| Part no. | Socket | 2/22.0/23.0/0.77' | 11kg |
| Content: 3/8" & 1/2" DR. | | | |
| 3/8"DR. Part: | | | |
| 535 13...19 | 7-6pt. Flank socket (MM) | 13; 14; 15; 16; 17; 18; 19 mm | |
| 535 3.8...11.16 | 4-6pt. Flank socket (SAE) | 3/8"; 1/2"; 9/16"; 11/16" | |
| 53563 08...19 | 11-6pt. Flank deep socket (MM) | 8; 10; 11; 12; 13; 14; 15; 16; 17; 18; 19 mm | |
| 53563 | 4-6pt. Flank deep socket (SAE) | 3/8"; 1/2"; 9/16"; 11/16" | |
| 8073 16...20.6 | 3-Spark plug socket | 16; 18; 20.6 mm | |
| 802311 | 1-Ratchet handle | | |
| 8043 075...250 | 2-Extension bar 3"; 10" | | |
| 80643 | 1-Adaptor for extension | 1/2"(F) to 3/8"(M) | |
| 8033165 | 1-Sliding T handle | | |
| 80531 | 1-Universal joint | | |
| 1/2"DR. Part: | | | |
| 545 20...32 | 11-6pt. Flank socket (MM) | 20; 21; 22; 23; 24; 25; 26; 27; 28; 30; 32 mm | |
| 54577 13.16...1.1.8 | 3-6pt. Flank deep socket (SAE) | 13/16"; 1"; 1-1/8" | |
| 548W 3.16...3.4 | 9-12pt. WW socket | 3/16"; 1/4"; 5/16"; 3/8"; 7/16"; 1/2"; 9/16"; 5/8"; 3/4" | |
| 802411 | 1-Ratchet handle | | |
| 8044 125...250 | 2-Extension bar 5"; 10" | | |
| 8014380 | 1-Swivel handle 15" | | |
| 8154410A | 1-Speed handle | | |
| 80541 | 1-Universal joint | | |



64pc Star set

| 4651 | Bit | 3/20.3/21.3/1' | 6766g |
|---------------------------------|--------------------------------------|--|-------|
| Part no. | Bit | 3/20.3/21.3/1' | 6766g |
| Content: 1/4" & 3/8" & 1/2" DR. | | | |
| 11-Star socket | | | |
| 526 04...10 | 1/4": E4; E5; E6; E8; E10 | | |
| 546 10...24 | 1/2": E10; E12; E14; E18; E20; E24 | | |
| 11-Impact star socket | | | |
| 426 04...10 | 1/4": E4; E5; E6; E8; E10 | | |
| 446 10...24 | 1/2": E10; E12; E14; E18; E20; E24 | | |
| 346055 40...60 | 5-Star socket bit | T40; T45; T50; T55; T60 (55mmL) | |
| 246 30...60 | 5-Impact star socket bit (one-piece) | T30; T40; T50; T55; T60 (40mmL) | |
| 716 06...30 | 7-Star screwdriver | T6; T8; T10; T15; T20; T25; T30 | |
| 766 08...60 | 11-Star key | T8; T10; T15; T20; T25; T27; T30; T45; T50; T55; T60 | |
| 756 0608...2024 | 4-Star wrench | E6xE8; E10xE12; E14xE18; E20xE24 | |
| 12625 08...30 | 7-1/4" Star bit (25mmL) | T8; T9; T10; T15; T20; T25; T30 | |
| 15635 40...50 | 3-5/16" Star bit (35mmL) | T40; T45; T50 | |



NEW



65pc Socket set

| 4652 | | |
|--|---|--------|
| Part no. | 2/28.5/29.5/0.77" | 14.2kg |
| Content: 1/4" & 1/2" & 3/4" DR. 1/4"DR. Part: | | |
| 12-6pt. Flank socket | | |
| 525 04...12 | 4; 5.5; 6; 7; 8; 9; 10; 11; 12 mm | |
| 525 3.16...3.8 | 3/16"; 1/4"; 3/8" | |
| 80222 | 1-Ratchet handle | |
| 8012140 | 1-1/4" Swivel handle | |
| 8032115 | 1-Sliding T handle | |
| 8143 | 1-Spinner handle | |
| 8042 050...150 | 2-Extension bar 50; 150 mm | |
| 80521 | 1-Universal joint | |
| 8032115A | 1-Cross bar 115 mm | |
| 1/2"DR. Part: | | |
| 26-6pt. Flank socket | | |
| 545 08...32 | 8; 9; 10; 11; 12; 13; 14; 15; 16; 17; 19; 20; 21; 22; 23; 24; 26; 27; 29; 30; 32 mm | |
| 545 3.8...1 | 3/8"; 1/2"; 9/16"; 11/16"; 1" | |
| 80242 | 1-Ratchet handle | |
| 8014380 | 1-Swivel handle 15" | |
| 8034250 | 1-Sliding T handle | |
| 8044 075...250 | 3-Extension bar 75; 125; 250 mm | |
| 80541 | 1-Universal joint | |
| 8034150A | 1-Cross bar 150mmL | |
| 3/4"DR. Part: | | |
| 9-12pt. Flank socket | | |
| 569 26...41 | 26; 27; 29; 30; 32; 35; 36; 38; 41 mm | |
| 8026500 | 1-Ratchet handle 500 mmL | |
| 8046200 | 1-Extension bar 200 mmL | |



65pc Combination set

| 4653 | | |
|--|--|-------|
| Part no. | 5/24.0/25.0/1.4' | 4800g |
| Content: 1/4" & 1/2"DR. 1/4"DR. Part: | | |
| 10-6pt. Flank socket | | |
| 525 055...14 | 5.5; 6; 7; 8; 9; 10; 11; 12; 13; 14 mm | |
| 80222 | 1-Ratchet handle | |
| 8032115 | 1-Sliding T handle | |
| 8042 050...100 | 2-Extension bar 2" & 4" | |
| 80521 | 1-Universal joint | |
| 8143 | 1-Spinner | |
| 1/2"DR. Part: | | |
| 13-Surface drive socket | | |
| 547 08...32 | 8; 10; 12; 13; 14; 15; 17; 19; 22; 24; 27; 30; 32 mm | |
| 8014380 | 1-Swivel handle 15"(380mmL) | |
| 802415 | 1-Ratchet handle | |
| 8034300 | 1-Sliding T handle 12"(300mmL) | |
| 8044 125...250 | 2-Extension bar 5"; 10" | |
| 80541 | 1-Universal joint | |
| 8074 16...20.6 | 2-Spark plug socket 16; 20.6mm | |
| Others: | | |
| 611175 | 1-Combination pliers 7" | |
| 612140 | 1-Mini diagonal pliers 110mmL | |
| 613250 | 1-Waterpump pliers 10" | |
| 616500 | 1-Engineer hammer 500gw | |
| 711 1...2 | 2-Phillips screwdriver PH.1x80mmL; PH.2x100mmL | |

| 4653 | | | |
|-----------------|---|------------------|-------|
| Part no. | Socket | 5/24.0/25.0/1.4' | 4800g |
| 7112S | 1-Stubby Phillips screwdriver PH.2x25mmL | | |
| 713 | 2-Slotted screwdriver 5.5x125mmL; 6.5x150mmL | | |
| 055...065 | 1-Stubby slotted screwdriver 5.5mm(25mmL) | | |
| 713055S | 4-Hinged socket wrench 8x10; 12x13; 14x15; 17x19 mm | | |
| 752 0810...1719 | 10-Combination wrench 6; 8; 10; 12; 13; 14; 15; 17; 19; 22 mm | | |
| 755 06... 22 | 4-Hex key 6; 8; 10;12 mm | | |
| 764 06...12 | | | |

NEW



67pc 1/4" & 1/2" DR. Socket combination set

| 4671 | | | |
|--|--|------------------|--------|
| Part no. | Socket | 2/20.4/21.4/1.1' | 10.2Kg |
| Content: 1/4"DR. & 1/2"DR. 1/4" DR. part: | | | |
| 12-Double-sized bit (165mmL) | | | |
| 121D 12...34 | Phillips PH.1 x PH.2; PH.3 x PH. 4 | | |
| 122D 12...34 | Pozidriv PZ.1 x PZ.2; PZ.3 x PZ. 4 | | |
| 123D 0304...05507 | Slotted 3x4mm; 5.5x7mm | | |
| 124D 0304...0506 | Hex 3x4mm; 5x6mm | | |
| 126D 0810...3040 | Star T8xT10; T15xT20; T25xT27; T30xT40 | | |
| 525 04...13 | 12-6pt. Flank Socket 4; 4.5; 5; 5.5; 6; 7; 8; 9; 10; 11; 12; 13 mm | | |

| 4671 | | | |
|----------------------|---|------------------|--------|
| Part no. | Socket | 2/20.4/21.4/1.1' | 10.2Kg |
| 802234 | 1-Swivel ratchet handle | | |
| 8152R | 1-Ratchet bit driver handle | | |
| 80922 | 1-Adapter 1/4"inhex*1/4"(M) | | |
| 8042075 | 1-Extension 3" | | |
| 1/2" DR. part: | | | |
| 25-6pt. Flank Socket | | | |
| 545 11...36 | 11; 12; 13; 14; 15; 16; 17; 18; 19; 20; 21; 22; 23; 24; 25; 26; 27; 28; 29; 30; 32; 33; 34; 35; 36 mm | | |
| 802434 | 1-Adjustable swivel ratchet handle | | |
| 8044125 | 1-Extension 5" | | |
| 807416...20.6 | 3-Spark plug socket 16; 18; 20.6mm | | |
| Others: | | | |
| 610200 | 1-Waterpump pliers 8" | | |
| 611215 | 1-Combination pliers 8.5" | | |
| 614250 | 1-Locking pliers 10" | | |
| 616300 | 1-Engineer hammer 300gw | | |
| 649250 | 1-Adjustable gauged wrench (250mmL) | | |
| 764 08...14 | 4-Hex key 8; 10; 12; 14 mm | | |



68pc Combination set

| Part no. | Socket | 5/24.0/25.0/1.4' | 4800g |
|-------------------------|---------------------------------------|---|-------|
| 4682 | | | |
| Content: 1/4" & 1/2"DR. | | | |
| 1/4"DR. Part: | | | |
| 527 04...14 | 13-Surface drive socket | 4; 4.5; 5; 5.5; 6; 7; 8; 9; 10; 11; 12; 13; 14 mm | |
| | 22-Socket bit (32mmL) | | |
| 32332 04...07 | Slotted 4; 5.5; 7 mm | | |
| 32432 03...08 | Hex 3; 4; 5; 6; 7; 8 mm | | |
| 32132 1...3 | Phillips PH.1; PH.2; PH.3 | | |
| 32232 1...3 | Pozidriv PZ.1; PZ.2; PZ.3 | | |
| 32632 08...30 | Star T8; T10; T15; T20; T25; T27; T30 | | |
| 80222 | 1-Ratchet handle | | |
| 8042 050...100 | 2-Extension bar 2"; 4" | | |
| 8032115 | 1-Sliding T handle | | |
| 8111 | 1-Flexible extension | | |
| 80521 | 1-Universal joint | | |
| 8143 | 1-Spinner 6" | | |
| 764 0127...025 | 4-Hex key 1.27; 1.5; 2; 2.5 mm | | |
| 1/2"DR. Part: | | | |
| 547 10...32 | 15-Surface drive socket | 10; 11; 12; 13; 14; 15; 16; 17; 18; 19; 22; 24; 27; 30; 32 mm | |
| 80242 | 1-Ratchet handle | | |
| 8044 125...250 | 2-Extension bar 5"; 10" | | |
| 8074 16...20.6 | 2-Spark plug socket 16; 20.6 mm | | |
| 80541 | 1-Universal joint | | |
| 80634 | 1-Adaptor for extension | 3/8"(F)x1/2"(M) | |

| Part no. | Socket | 5/24.0/25.0/1.4' | 4800g |
|-------------------------|-----------------------|---|-------|
| 4682-5 | | | |
| Content: 1/4" & 1/2"DR. | | | |
| 1/4"DR. Part: | | | |
| 525 04...14 | 13-6pt. Flank socket | 4; 4.5; 5; 5.5; 6; 7; 8; 9; 10; 11; 12; 13; 14 mm | |
| 1/2"DR. Part: | | | |
| 545 10...32 | 15-6pt. Flank socket | 10; 11; 12; 13; 14; 15; 16; 17; 18; 19; 22; 24; 27; 30; 32 mm | |
| 4682-9 | | | |
| Content: 1/4" & 1/2"DR. | | | |
| 1/4"DR. Part: | | | |
| 529 04...14 | 13-12pt. Flank socket | 4; 4.5; 5; 5.5; 6; 7; 8; 9; 10; 11; 12; 13; 14 mm | |
| 1/2"DR. Part: | | | |
| 549 10...32 | 15-12pt. Flank socket | 10; 11; 12; 13; 14; 15; 16; 17; 18; 19; 22; 24; 27; 30; 32 mm | |



68pc Combination set

| Part no. | Socket | 3/17.6/18.6/1' | 5850g |
|-------------------------|--|---|-------|
| 4683 | | | |
| Content: 1/4" & 1/2"DR. | | | |
| 1/4"DR. Part: | | | |
| 525 04...13 | 12-6pt. Flank socket | 4; 4.5; 5; 5.5; 6; 7; 8; 9; 10; 11; 12; 13 mm | |
| | 20-Socket bit (32mmL) | | |
| 32132 1...2 | Phillips PH.1; PH.2 | | |
| 32232 1...2 | Pozidriv PZ.1; PZ.2 | | |
| 32332 04...065 | Slotted 4; 5.5; 6.5 mm | | |
| 32432 03...08 | Hex 3; 4; 5; 6; 8 mm | | |
| 32632 08...40 | Star T8; T10; T15; T20; T25; T27; T30; T40 | | |
| 80229 | 1-72 teeth ratchet handle | | |
| 8032115 | 1-Sliding T handle | | |
| 8042 050...100 | 2-Extension bar 2"; 4" | | |
| 80521 | 1-Universal joint | | |
| 8143 | 1-Spinner 6" | | |
| 764 0127...025 | 4-Hex key 1.27; 1.5; 2; 2.5 mm | | |
| 1/2"DR. Part: | | | |
| 545 10...32 | 18-6pt. Flank socket | 10; 11; 12; 13; 14; 15; 16; 17; 18; 19; 20; 21; 22; 23; 24; 27; 30; 32 mm | |
| 80249 | 1-72 teeth ratchet handle | | |
| 8044 075...250 | 3-Extension bar 3"; 5"; 10" | | |
| 80541 | 1-Universal joint | | |
| 80634 | 1-Adaptor for extension | 3/8"(F)x1/2"(M) | |
| 8074 16...20.6 | 2-Spark plug socket 16; 20.6mm | | |



73pc Star set

| Part no. | Bit | 3/13.5/14.5/1' | 4500g |
|-------------------------|-----------------------------------|--|-------|
| 4731 | | | |
| Content: 1/4" & 1/2"DR. | | | |
| 766 08...70 | 13-Star key | T8; T10; T15; T20; T25; T27; T30; T40; T45; T50; T55; T60; T70 | |
| 756 0608...2024 | 4-Star wrench | E6xE8; E10xE12; E14xE18; E20xE24 | |
| 546 12...24 | 7-1/2"DR. Star socket | E12; E14; E16; E18; E20; E22; E24 | |
| 526 04...11 | 7-1/4"DR. Star socket | E4; E5; E6; E7; E8; E10; E11 | |
| 346055 30...60 | 6-1/2"DR. Star socket bit (55mmL) | T30; T40; T45; T50; T55; T60 | |
| 32632 08...27 | 6-1/4"DR. Star socket bit (32mmL) | T8; T10; T15; T20; T25; T27 | |
| 17730 10...55 | 10-10mm Star tamperproof bit | T-10H; T-15H; T-20H; T-25H; T-27H; T-30H; T-40H; T-45H; T-50H; T-55H (30mmL) | |
| 17675 10...55 | 10-10mm Star bit | T10; T15; T20; T25; T27; T30; T40; T45; T50; T55 (75mmL) | |
| 81047 | 1-Bit holder 1/2"DR.x10mm | | |
| 717 06...40 | 9-Star tamperproof screwdriver | T-6H; T-8H; T-10H; T-15H; T-20H; T-25H; T-27H; T-30H; T-40H | |



76pc Combination set

| 4761 | Socket | 3/20.7/21.7/1.7' | 6900g |
|-------------------------|---|------------------|-------|
| Part no. | Socket | 3/20.7/21.7/1.7' | 6900g |
| Content: 1/4" & 1/2"DR. | | | |
| 527 04...14 | 1/4"DR. Part: 13-Surface driver socket 4; 4.5; 5; 5.5; 6; 7; 8; 9; 10; 11; 12; 13; 14 mm | | |
| 80222 | 1-Ratchet handle | | |
| 8042 050...100 | 2-Extension bar 2"; 4" | | |
| 8032115 | 1-Sliding T handle | | |
| 80521 | 1-Universal joint | | |
| 8143 | 1-Spinner 6" | | |
| 764 015...025 | 3-Hex key 1.5; 2; 2.5 mm | | |
| 1/2"DR. Part: | | | |
| 547 08...32 | 18-Surface drive socket 8; 10; 11; 12; 13; 14; 15; 16; 17; 18; 19; 20; 21; 22; 24; 27; 30; 32 mm | | |
| 80242 | 1-Ratchet handle | | |
| 8074 16...20.6 | 2-Spark plug socket 16; 20.6mm | | |
| 8044 125...250 | 2-Extension bar 5"; 10" | | |
| 80541 | 1-Universal joint | | |
| 80634 | 1-Adaptor for extension 3/8"DR.x1/2"(M) | | |
| 755 08...22 | 9-Combination wrench 8; 10; 11; 12; 13; 14; 17; 19; 22 mm | | |
| 5102A | 10pc Hex short key set | | |
| 764 0127A...10A | 1.27; 1.5; 2; 2.5; 3; 4; 5; 6; 8; 10 mm | | |
| 5102XLBA | 10pc Hex extra long ball key set | | |
| 7650127XLA...10XLA | 1.27; 1.5; 2; 2.5; 3; 4; 5; 6; 8; 10 mm | | |

| 4761-5 | Socket | 3/20.7/21.7/1.7' | 6900g |
|-------------------------|--|------------------|-------|
| Part no. | Socket | 3/20.7/21.7/1.7' | 6900g |
| Content: 1/4" & 1/2"DR. | | | |
| 525 04...14 | 1/4"DR. Part: 13-6pt. Flank socket 4; 4.5; 5; 5.5; 6; 7; 8; 9; 10; 11; 12; 13; 14 mm | | |
| 545 08...32 | 1/2"DR. Part: 18-6pt. Flank socket 8; 10; 11; 12; 13; 14; 15; 16; 17; 18; 19; 20; 21; 22; 24; 27; 30; 32 mm | | |

| 4761-9 | Socket | 3/20.7/21.7/1.7' | 6900g |
|-------------------------|---|------------------|-------|
| Part no. | Socket | 3/20.7/21.7/1.7' | 6900g |
| Content: 1/4" & 1/2"DR. | | | |
| 529 04...14 | 1/4"DR. Part: 13-12pt. Flank socket 4; 4.5; 5; 5.5; 6; 7; 8; 9; 10; 11; 12; 13; 14 mm | | |
| 549 08...32 | 1/2"DR. Part: 18-12pt. Flank socket 8; 10; 11; 12; 13; 14; 15; 16; 17; 18; 19; 20; 21; 22; 24; 27; 30; 32 mm | | |



77pc Combination Set

| 4771 | Socket | 3/22.1/23.1/1.7' | 7380g |
|-------------------------|--|------------------|-------|
| Part no. | Socket | 3/22.1/23.1/1.7' | 7380g |
| Content: 1/4" & 1/2"DR. | | | |
| 525 04...12 | 1/4"DR. Part: 11-6pt. Flank socket 4; 4.5; 5; 5.5; 6; 7; 8; 9; 10; 11; 12 mm | | |
| 81022 | 1-Bit holder | | |
| 81225 | 1-Magnetic socket pick-up | | |
| 8143 | 1-Spinner 6" | | |
| 8042 050...100 | 2-Extension bar 2" & 4" | | |
| 80521 | 1-Universal joint | | |
| 802223 | 1-72 teeth flexible ratchet | | |
| 21111 | 11pc bit set Phillips PH.0; PH.1; PH.2; PH.3 Pozidriv PZ.0; PZ.1; PZ.2; PZ.3 Slotted 5.5; 6.5 mm Magnetic quick-release bit holder | | |
| 1/2"DR. Part: | | | |
| 545 10...24 | 12-6pt. Flank socket 10; 11; 12; 13; 14; 15; 16; 17; 18; 19; 22; 24 mm | | |
| 80242 | 1-24 teeth Ratchet | | |
| 80541 | 1-Universal joint | | |
| 8044 125...250 | 2-Extension bar 5" & 10" | | |
| 80634 | 1-Adaptor for Extension 3/8"(F) x 1/2"(M) | | |
| 8074 16...20.6 | 2-Spark plug socket 16 & 20.6mm | | |
| Others : | | | |
| 66302 | 1-Mini hacksaw | | |
| 5055P3 | 2pc Saw blade | | |
| 616300 | 1-Engineer hammer 300g | | |

| 4771 | Socket | 3/22.1/23.1/1.7' | 7380g |
|-------------|---|------------------|-------|
| Part no. | Socket | 3/22.1/23.1/1.7' | 7380g |
| 68601 | 1-LED white light, clip-type (360" rotation) | | |
| 755 08...19 | 9-Combination wrench 8; 10; 11; 12; 13; 14; 15; 17; 19 mm | | |
| 611B160 | 1-Combination pliers | | |
| 610B160 | 1-Long nose pliers | | |
| 613B250 | 1-Waterpump pliers | | |
| 5055P4 | 1-Utility Knife (incl. 2pc blades) | | |
| 2125P1 | 1-Induction circuit tester | | |
| 5102LB | 10pc Hex ball point long key set 1.27; 1.5; 2; 2.5; 3; 4; 5; 6; 8; 10 mm | | |



NEW



77pc 1/4" & 1/2" Combination set

| 4772 | | | |
|-------------|--------|----------------|-------|
| Part no. | Socket | 3/17.0/18.0/1' | 5666g |

Content: 1/4" & 1/2" DR.

1/4" Part :

525 04...12 9-6pt. Flank socket
4; 5; 6; 7; 8; 9; 10; 11; 12 mm

80222 1-Ratchet handle 24th

81022 1-Bit holder 1/4"(F)x1/4"inhex

80521 1-Universal joint

8042100 1-Extension 4"

8032115 1-Sliding T handle 115mmL

12630 08...30 6-Star bit
T8; T10; T15; T20; T25; T30

12430 02...06 5-Hex bit
2; 3; 4; 5; 6 mm

12330 03...065 4-Slotted bit
3; 4; 5.5; 6.5 mm

12130 0...3 4-Phillips bit
PH.0; PH.1; PH.2; PH.3

12230 1...3 3-Pozidriv bit
PZ.1; PZ.2; PZ.3

8092230 1-Bit adaptor 1/4"Hex-1/4"Sq.

1/2" Part :

545 10...32 13-6pt. Flank socket
10; 11; 12; 13; 14; 15; 17; 19;
22; 24; 27; 30; 32 mm

80243 1-24 teeth Ratchet handle

8044 125...250 2-Extension 5"; 10"

80541 1-Universal joint

807420.6 1-Spark plug socket 20.6 mm(13/16")

Others:

752 0809...1415 4-Hinged socket wrench
8x9; 10x11; 12x13; 14x15 mm

764 025...10 7-Hex key 2.5; 3; 4; 5; 6; 8; 10 mm

755 07...19 11-Combination wrench
7; 8; 9; 10; 11; 12; 13; 14;
15; 17; 19 mm



82pc Combination set

| 4821 | | | |
|-------------|--------|----------------|-------|
| Part no. | Socket | 3/18.0/19.0/1' | 6000g |

Content: 1/4" & 1/2"DR.

1/4"DR. Part:

527 04...14 13-Surface driver socket
4; 4.5; 5; 5.5; 6; 7; 8; 9; 10; 11;
12; 13; 14 mm

32432 03...06 17-Socket bit (32mmL)
Hex 3; 4; 5; 6 mm

32632 08...30 Star T8; T10; T15; T20; T25; T30

32332 04...065 Slotted 4; 5.5; 6.5 mm

32132 1...2 Phillips PH.1; PH.2

32232 1...2 Pozidriv PZ.1; PZ.2

80222 1-Ratchet handle

8032115 1-Sliding T handle

8042 050...100 2-Extension bar 2"; 4"

80521 1-Universal joint

8111 1-Flexible extension

8143 1-Spinner 6"

8092225 1-Bit adaptor 25mmL

1/2"DR. Part:

547 14...32 12-Surface driver socket
14; 15; 16; 17; 18; 19; 20; 22; 24;
27; 30; 32 mm

15430 08...14 15-5/16" bit (30mmL)
Hex 8; 10; 12; 14 mm

15630 40...55 Star T40; T45; T50; T55

15330 08...12 Slotted 8; 10; 12 mm

NEW



83pc Combination set

| 4832 | | | |
|-------------|--------|-------------------|-------|
| Part no. | Socket | 2/18.8/19.8/1.54' | 9392g |

Content: 1/4" & 1/2" DR.

1/4"DR.

525 04...13 10-6pt. Flank socket
4; 5; 6; 7; 8; 9; 10; 11; 12; 13 mm

52550 05...10 5-6pt. Flank deep socket (50mmL)
5; 6; 7; 8; 10 mm

80222 1-Ratchet handle 24th

8042100 1-Extension 4"

8143 1-Spinner 6"

80521 1-Universal joint

81022 1-Bit holder 1/4"(F)x1/4"inhex

12630 08...40 8-Star bit
T8; T10; T15; T20; T25; T27; T30; T40

12430 03...06 4-Hex bit
3; 4; 5; 6 mm

12330 04...065 3-Slotted bit
4; 5.5; 6.5 mm

12130 1...3 3-Phillips bit
PH.1; PH.2; PH.3

12230 1...3 3-Pozidriv bit
PZ.1; PZ.2; PZ.3

8092230 1-Bit adaptor 1/4"Hex-1/4"Sq.
1/2"DR.

545 10...32 13-6pt. Flank socket
10; 11; 12; 13; 14; 15; 17; 19;
22; 24; 27; 30; 32 mm

8334300 1-Adjustable handle (turn-lock design)

802433 1-Ratchet handle

803A4300 1-Sliding T bar (300mmL)

815A4315 1-105° L handle 315mmL

8044125 1-Extension bar 5"

80541 1-Universal joint

8074 16...20.6 2-Spark plug socket 16; 20.6 mm

| 4821 | | | |
|----------------|--|----------------|-------|
| Part no. | Socket | 3/18.0/19.0/1' | 6000g |
| 15130 3...4 | Phillips PH.3; PH.4 | | |
| 15230 3...4 | Pozidriv PZ.3; PZ.4 | | |
| 80243 | 1-Ratchet handle | | |
| 80541 | 1-Universal joint | | |
| 8044 125...250 | 2-Extension bar 5"; 10" | | |
| 8074 16...20.6 | 2-Spark plug socket 16; 20.6 mm | | |
| 81045 | 1-Bit holder 1/2"DR.x5/16" | | |
| 80634 | 1-Adaptor for extension 3/8"(F)x1/2"(M) | | |
| 755 08...22 | 9-Combination wrench 8; 10; 11; 12; 13; 14; 17; 19; 22 mm | | |

| 4821-5 | | | |
|----------------------|--|----------------|-------|
| Part no. | Socket | 3/18.0/19.0/1' | 6000g |
| Changed Items | Content: 1/4" & 1/2"DR. | | |
| 525 04...14 | 1/4"DR. Part: 13-6pt. Flank socket 4; 4.5; 5; 5.5; 6; 7; 8; 9; 10; 11; 12; 13; 14 mm | | |
| 545 14...32 | 1/2"DR. Part: 12-6pt. Flank socket 14; 15; 16; 17; 18; 19; 20; 22; 24; 27; 30; 32 mm | | |

| 4821-9 | | | |
|----------------------|---|----------------|-------|
| Part no. | Socket | 3/18.0/19.0/1' | 6000g |
| Changed Items | Content: 1/4" & 1/2"DR. | | |
| 529 04...14 | 1/4"DR. Part: 13-12pt. Flank socket 4; 4.5; 5; 5.5; 6; 7; 8; 9; 10; 11; 12; 13; 14 mm | | |
| 549 14...32 | 1/2"DR. Part: 12-12pt. Flank socket 14; 15; 16; 17; 18; 19; 20; 22; 24; 27; 30; 32 mm | | |



| 4832 | | | |
|---------------|---|-------------------|-------|
| Part no. | Socket | 2/18.8/19.8/1.54' | 9392g |
| Others: | | | |
| 755 10...19 | 8-Combination wrench 10; 11; 12; 13; 14; 15; 17; 19 mm | | |
| 614250 | 1-Locking pliers 10" | | |
| 613B250 | 1-Waterpump pliers 10" | | |
| 611B200 | 1-Combination pliers 8" | | |
| 764 015...025 | 3-Hex key 1.5; 2; 2.5 mm | | |
| 616300 | 1-Engineer hammer 300g | | |
| 7112S | 1-Stubby Phillips screwdriver PH.2x25mmL | | |
| 713065S | 1-Stubby slotted screwdriver 6.5mmx25mmL | | |
| 711 1...2 | 2-Phillips screwdriver PH.1x80mmL; PH.2x100mmL | | |
| 713065 | 1-Slotted screwdriver 6.5mmx150mmL | | |



91pc Combination Set

| 4911 | | | |
|--|--|-------------------|--------|
| Part no. | Socket | 2/20.0/21.0/1.54' | 10000g |
| Content: 1/4" & 1/2"DR. 1/4"DR. Part: | | | |
| 24-1/4"Bit (30mmL) | | | |
| 12130 0...3 | Phillips PH.0; PH.1; PH.2; PH.3 | | |
| 12230 1...3 | Pozidriv PZ.1; PZ.2; PZ.3 | | |
| 12330 055...07 | Slotted 5.5; 7 mm | | |
| 12430 02...10 | Hex 2; 3; 4; 5; 6; 7; 8; 10 mm | | |
| 12730 10...40 | Star tamperproof T-10H; T15H; T-20H; T-25H; T-27H; T-30H; T-40H | | |
| 12-6pt. Flank socket | | | |
| 525 04...13 | 4; 4.5; 5; 5.5; 6; 7; 8; 9; 10; 11; 12; 13 mm | | |
| 80222 | 1-24 teeth ratchet | | |
| 8032115 | 1-Sliding T handle | | |
| 8042 050...100 | 2-Extension bar 2"; 4" | | |
| 80521 | 1-Universal joint | | |
| 81022 | 1-Bit holder | | |
| 8111 | 1-Flexible extension | | |
| 81225 | 1-Magnetic socket pick-up | | |
| 8143 | 1-Spinner 6" | | |
| 1/2"DR. Part: | | | |
| 12-6pt. Flank socket | | | |
| 545 08...21 | 8; 10; 12; 13; 14; 15; 16; 17; 18; 19; 20; 21 mm | | |
| 5-6pt. Flank deep socket | | | |
| 54577 22...32 | 22; 24; 27; 30; 32 mm | | |

| 4911 | | | |
|--|--|-------------------|--------|
| Part no. | Socket | 2/20.0/21.0/1.54' | 10000g |
| 8014380 | 1-Swivel handle (380mmL) | | |
| 80243 | 1-24 teeth Ratchet - thin | | |
| 8044 050W... 125W | 2-Wobble extension 2"; 5" | | |
| 8044250 | 1-Extension bar 10" | | |
| 80541 | 1-Universal joint | | |
| 80634 | 1-Adaptor for Extension 3/8"(F) x 1/2"(M) | | |
| 8074 16...20.6 | 2-Spark plug socket 16 & 20.6 mm | | |
| Others: | | | |
| 755 06...22 | 10-Combination wrench 6; 8; 10; 12; 13; 14; 15; 17; 19; 22 mm | | |
| 616300 | 1-Engineering hammer 300gw | | |
| 610B200 | 1-Long nose pliers 8" | | |
| 611B175 | 1-Combination pliers 7" | | |
| 613B250 | 1-Waterpump pliers 10" | | |
| 6046210 | 1-Pin punch 6 (210mmL) | | |
| 60215180 | 1-Chisel 15 (180mmL) | | |
| 7111S | 1-Stubby phillips screwdriver PH.1 | | |
| 7112 | 1-Phillips screwdriver PH.2 | | |
| 713055S | 1-Stubby slotted screwdriver 5.5mm x25mmL | | |
| 713065 | 1-Slotted screwdriver 6.5mm x 150mmL | | |
| 4911-9 | | | |
| Part no. | Socket | 2/20.0/21.0/1.54' | 10000g |
| Changed Items | | | |
| Content: 1/4" & 1/2"DR. 1/4"DR. Part: | | | |
| 12-12pt. Flank socket | | | |
| 529 04...13 | 4; 4.5; 5; 5.5; 6; 7; 8; 9; 10; 11; 12; 13 mm | | |
| 1/2"DR. Part: | | | |
| 12-12pt. Flank socket | | | |
| 549 08...21 | 8; 10; 12; 13; 14; 15; 16; 17; 18; 19; 20; 21 mm | | |
| 54977 22...32 | 5-12pt. Flank deep socket 22; 24; 27; 30; 32 mm | | |



91pc Combination Set

| 4921 | | | |
|-------------------------|---|-------------------|-------|
| Part no. | Bit | 2/11.7/12.7/0.77' | 5850g |
| Content: 1/4" & 1/2"DR. | | | |
| 756 | 6-Offset star wrench | | |
| 0608A...2024A | E6xE8; E7xE11; E10xE12; E14xE18; E16xE22;E20xE24 | | |
| 766 06...55 | 14-Star key T6; T7; T8; T9; T10; T15; T20; T25; T27; T30; T40;T45; T50; T55 | | |
| 71606 | 1-Star screwdriver T6 | | |
| 717 07...40 | 10-Star tamperproof screwdriver T-7H; T-8H; T-9H; T-10H; T-15H; T-20H; T-25H;T-27H; T-30H; T-40H; | | |
| 14-Star socket | | | |
| 526 04...11 | 1/4": E4; E5; E6; E7; E8; E10; E11 | | |
| 546 12...24 | 1/2": E12; E14; E16; E18; E20; E22; E24 | | |
| 4-1/2" Star socket bit | | | |
| 34614055 | T55 (140mmL) | | |
| 34605560 | T60 (55mmL) | | |
| 34610070 | T70 (100mmL) | | |
| 34607080 | T80 (70mmL) | | |
| 3-1/4" Star bit | | | |
| 12625 06...07 | T6; T7 (25mmL) | | |
| 1266525 | T25 (65mmL) | | |
| 12725 08...40 | 10-1/4" Star tamperproof bit (25mmL) T-8H; T-9H; T-10H; T-15H; T-20H; T-25H; T-27H;T-30H; T-35H; T-40H | | |
| 8-10mm Star bit | | | |
| 1763047 | T47 (30mmL) | | |
| 17675 40...50 | T40; T45; T50 (75mmL) | | |
| 17730 40...55 | T-40H; T45H; T-50H; T-55H (30mmL) | | |
| 2-Bit holder | | | |
| 810 22...47 | 1/4"DR.x1/4"(F); 1/2"DR.x10mm | | |
| 5201 | 20-Plastic star gauge | | |



94pc Combination set

| 4941 | | | |
|-------------------------|---------------------------------------|--|-------|
| Part no. | Socket | 3/21.0/22.0/1' | 7000g |
| Content: 1/4" & 1/2"DR. | | | |
| 1/4"DR. Part: | | | |
| 527 04...14 | 13-Surface driver socket | 4; 4.5; 5; 5.5; 6; 7; 8; 9; 10; 11; 12; 13; 14 mm | |
| 52750 06...13 | 8-Surface driver deep socket | 6; 7; 8; 9; 10; 11; 12; 13; (50mmL) | |
| 18-Socket bit (32mmL) | | | |
| 32432 03...06 | Hex 3; 4; 5; 6 mm | | |
| 32632 08...30 | Star T8; T10; T15; T20; T25; T27; T30 | | |
| 32332 04...065 | Slotted 4; 5.5; 6.5 mm | | |
| 32132 1...2 | Phillips PH.1; PH.2 | | |
| 32232 1...2 | Pozidriv PZ.1; PZ.2 | | |
| 80222 | 1-Ratchet handle | | |
| 8042 050...100 | 2-Extension bar 2"; 4" | | |
| 8032115 | 1-Sliding T handle | | |
| 80521 | 1-Universal joint | | |
| 8143 | 1-Spinner 6" | | |
| 764 015...025 | 3-Hex key 1.5; 2; 2.5 mm | | |
| 1/2"DR. Part: | | | |
| 547 10...32 | 17-Surface drive socket | 10; 11; 12; 13; 14; 15; 16; 17; 18; 19; 20; 21; 22; 24;27; 30; 32 mm | |
| 54777 14...22 | 5-Surface drive deep socket | 14; 15; 17; 19; 22; (77mmL) | |
| 16-5/16" bit (30mmL) | | | |
| 15430 07...14 | Hex 7; 8; 10; 12; 14 mm | | |
| 15630 40...55 | Star T40; T45; T50; T55 | | |

| 4941 | | | |
|----------------|---|----------------|-------|
| Part no. | Socket | 3/21.0/22.0/1' | 7000g |
| 15330 08...12 | Slotted 8; 10; 12 mm | | |
| 15130 3...4 | Phillips PH.3; PH.4 | | |
| 15230 3...4 | Pozidriv PZ.3; PZ.4 | | |
| 80242 | 1-Ratchet handle | | |
| 8074 16...20.6 | 2-Spark plug socket 16; 20.6mm | | |
| 8044 125...250 | 2-Extension bar 5"; 10" | | |
| 80541 | 1-Universal joint | | |
| 81045 | 1-Bit holder 1/2"DR.x5/16" | | |
| 80634 | 1-Adaptor for extension 3/8"DR.x1/2"(M) | | |

| 4941-5 | | | |
|-------------------------|--------------------------|--|-------|
| Part no. | Socket | 3/21.0/22.0/1' | 7000g |
| Changed Items | | | |
| Content: 1/4" & 1/2"DR. | | | |
| 1/4"DR. Part: | | | |
| 525 04...14 | 13-6pt. Flank socket | 4; 4.5; 5; 5.5; 6; 7; 8; 9; 10; 11; 12; 13; 14 mm | |
| 52550 06...13 | 8-6pt. Flank deep socket | 6; 7; 8; 9; 10; 11; 12; 13; (50mmL) | |
| 1/2"DR. Part: | | | |
| 545 10...32 | 17-6pt. Flank socket | 10; 11; 12; 13; 14; 15; 16; 17; 18; 19; 20; 21; 22; 24;27; 30; 32 mm | |
| 54577 14...22 | 5-6pt. Flank deep socket | 14; 15; 17; 19; 22; (77mmL) | |

| 4941-9 | | | |
|-------------------------|---------------------------|--|-------|
| Part no. | Socket | 3/21.0/22.0/1' | 7000g |
| Changed Items | | | |
| Content: 1/4" & 1/2"DR. | | | |
| 1/4"DR. Part: | | | |
| 529 04...14 | 13-12pt. Flank socket | 4; 4.5; 5; 5.5; 6; 7; 8; 9; 10; 11; 12; 13; 14 mm | |
| 52950 06...13 | 8-12pt. Flank deep socket | 6; 7; 8; 9; 10; 11; 12; 13; (50mmL) | |
| 1/2"DR. Part: | | | |
| 549 10...32 | 17-12pt. Flank socket | 10; 11; 12; 13; 14; 15; 16; 17; 18; 19; 20; 21; 22; 24;27; 30; 32 mm | |
| 54977 14...22 | 5-12pt. Flank deep socket | 14; 15; 17; 19; 22; (77mmL) | |



102pc Combination Set

| 41021 | | | |
|-------------------------|------------------------------|--|-------|
| Part no. | Socket | 2/19.5/20.5/1.54' | 9750g |
| Content: 1/4" & 1/2"DR. | | | |
| 1/4"DR. Part: | | | |
| 12725 06...40 | 11-Star tamperproof bit | T-6H; T- 7H; T- 8H; T- 9H; T- 10H; T-15H; T-20H; T-25H; T-27H; T-30H; T-40H | |
| 12425 02...10 | 10-Hex bit | 2; 2.5; 3; 4; 5;5.5; 6; 7; 8; 10 mm | |
| 525 04...10 | 9-6pt Flank socket | 4; 4.5; 5; 5.5; 6; 7; 8; 9; 10 mm | |
| 526 04...10 | 6-Star socket | E4; E5; E6; E7; E8; E10 | |
| 80222 | 1-24 teeth ratchet handle | | |
| 8032115 | 1-Sliding T handle 115mmL | | |
| 8042 100...150 | 2-Extension bar | 4"(100mmL); 6"(150mmL) | |
| 8111 | 1-Flexible extension 145mmL | | |
| 8143 | 1-Spinner 6"(150mmL) | | |
| 80521 | 1-Universal joint | | |
| 81022 | 1-Bit holder 1/4"(F)x1/4"(F) | | |
| 1/2"DR. Part: | | | |
| 545 08...32 | 20-6pt. Flank socket | 8; 9; 10; 11; 12; 13; 14; 15; 16; 17;18; 19; 20; 21; 22; 23; 24; 27; 30; 32 mm | |
| 546 10...18 | 5-Star socket | E10; E12; E14; E16; E18 | |

| 41021 | | | |
|-----------------|--|--|-------|
| Part no. | Socket | 2/19.5/20.5/1.54' | 9750g |
| 8034250 | 1-Sliding T handle 10"(250mmL) | | |
| 80243 | 1-24 teeth Thin ratchet handle | | |
| 8044250 | 1-Extension bar 10"(250mmL) | | |
| 8044050W | 1-Wobble extension | | |
| 8074 16...20.6 | 2-Spark plug socket 16; 20.6 mm | | |
| 80541 | 1-Universal joint | | |
| 8044125 | 1-Extension bar 5"(125mmL) | | |
| Others: | | | |
| 617 | 1-Multi-function magnetic pick-up | | |
| 711 1M...2M | 2-Hammer phillips screwdriver PH.1; PH.2 | | |
| 713 055M... | 2-Hammer slotted screwdriver | | |
| 065M | 5.5; 6.5 mm | | |
| 751 0810...1719 | 4-Flare nut wrench | 8x10; 11x13; 12x14; 17x19 mm | |
| 755 08...24 | 14-Combination wrench | 8; 10; 11; 12; 13; 14; 15; 16; 17; 18; 19; 21; 22; 24 mm | |
| 611B175 | 1-Combination pliers | | |
| 649200A | 1-Adjustable gauged wrench 8" (200mmL) | | |

| 41021-9 | | | |
|-------------------------|-----------------------|--|-------|
| Part no. | Socket | 2/19.5/20.5/1.54' | 9750g |
| Changed Items | | | |
| Content: 1/4" & 1/2"DR. | | | |
| 1/4"DR. Part: | | | |
| 529 04...10 | 9-12pt. Flank socket | 4; 4.5; 5; 5.5; 6; 7; 8; 9; 10 mm | |
| 1/2"DR. Part: | | | |
| 549 08...32 | 20-12pt. Flank socket | 8; 9; 10; 11; 12; 13; 14; 15; 16; 17;18; 19; 20; 21; 22; 23; 24; 27; 30; 32 mm | |



108pc Combination set

| Part no. | Socket | 3/22.8/23.8/1.7' | 7600g |
|-------------------------|---------------------------------------|---|-------|
| 41082 | | | |
| Content: 1/4" & 1/2"DR. | | | |
| 1/4"DR. Part: | | | |
| 527 04...14 | 13-Surface driver socket | 4; 4.5; 5; 5.5; 6; 7; 8; 9; 10; 11; 12; 13; 14 mm | |
| 52750 06...13 | 8- Surface driver deep socket | 6; 7; 8; 9; 10; 11; 12; 13 (50mmL) | |
| 526 04...08 | 5- 1/4" Torx socket | E4; E5; E6; E7; E8 | |
| 18-Socket bit (32mmL) | | | |
| 32432 03...06 | Hex 3; 4; 5; 6 | | |
| 32632 08...30 | Star T8; T10; T15; T20; T25; T27; T30 | | |
| 32332 04...065 | Slotted 4; 5.5; 6.5 | | |
| 32132 1...2 | Phillips PH.1; PH.2 | | |
| 32232 1...2 | Pozidriv PZ.1; PZ.2 | | |
| 80222 | 1- Ratchet handle | | |
| 8042 050...100 | 2- Extension bar 2"; 4" | | |
| 8032115 | 1- Sliding T handle | | |
| 80521 | 1- Universal joint | | |
| 8143 | 1- Spinner 6" | | |
| 764 015...025 | 3- Hex key 1.5; 2; 2.5 | | |
| 1/2"DR. Part: | | | |
| 547 10...32 | 17-Surface drive socket | 10; 11; 12; 13; 14; 15; 16; 17; 18; 19; 20; 21; 22; 24; 27; 30; 32 mm | |
| 54777 14...22 | 5- Surface drive deep socket | 14; 15; 17; 19; 22 (77mmL) | |

| Part no. | Socket | 3/22.8/23.8/1.7' | 7600g |
|----------------------|--|--|-------|
| 41082 | | | |
| 546 10...24 | 8- 1/2" Torx socket | E10; E11; E12; E14; E16; E18; E20; E24 | |
| 17-5/16" bit (30mmL) | | | |
| 15430 07...14 | Hex 7; 8; 10; 12; 14 | | |
| 15630 40...60 | Star T40; T45; T50; T55; T60 | | |
| 15330 08...12 | Slotted 8; 10; 12 | | |
| 15130 3...4 | Phillips PH.3; PH.4 | | |
| 15230 3...4 | Pozidriv PZ.3; PZ.4 | | |
| 80242 | 1- Ratchet handle | | |
| 8074 16...20.6 | 2- Spark plug socket 16; 20.6mm | | |
| 8044125W | 1- Wobble extension 5" | | |
| 8044250 | 1- Extension bar 10" | | |
| 80541 | 1- Universal joint | | |
| 81045 | 1- Bit holder 1/2"DR.x5/16" | | |
| 80634 | 1- Adaptor for extension 3/8"DR.x1/2"(M) | | |

| Part no. | Socket | 3/22.8/23.8/1.7' | 7600g |
|-------------------------|---------------------------|---|-------|
| 41082-9 | | | |
| Content: 1/4" & 1/2"DR. | | | |
| 1/4"DR. Part: | | | |
| 529 04...14 | 13-12pt. Flank socket | 4; 4.5; 5; 5.5; 6; 7; 8; 9; 10; 11; 12; 13; 14 mm | |
| 52950 06...13 | 8-12pt. Flank deep socket | 6; 7; 8; 9; 10; 11; 12; 13 (50mmL) | |
| 1/2"DR. Part: | | | |
| 549 10...32 | 17-12pt. Flank socket | 10; 11; 12; 13; 14; 15; 16; 17; 18; 19; 20; 21; 22; 24; 27; 30; 32 mm | |
| 54977 14...22 | 5-12pt. Flank deep socket | 14; 15; 17; 19; 22 (77mmL) | |

NEW



110pc Combination set

| Part no. | Socket | 2/20.6/21.6/1.54' | 10.3kg |
|--------------------------|--------------------------------|-------------------------------------|--------|
| 41101 | | | |
| Content: 1/4" & 1/2" DR. | | | |
| 1/4"DR. | | | |
| 525 04...13 | 10-6pt. Flank socket | 4; 5; 6; 7; 8; 9; 10; 11; 12; 13 mm | |
| 80222 | 1-Ratchet handle 24th | | |
| 8042 050...100 | 2-Extension 2"; 4" | | |
| 80521 | 1-Universal joint | | |
| 8111 | 1-Flexible extension 145mmL | | |
| 8143 | 1-Spinner 6" | | |
| 81022 | 1-Bit holder 1/4"(F)x1/4"inhex | | |
| 12330 03...065 | 4-Slotted bit | 3; 4; 5.5; 6.5 mm | |
| 12630 08...30 | 7-Star bit | T8; T10; T15; T20; T25; T27; T30 | |
| 12130 0...2 | 3-Phillips bit | PH.0; PH.1; PH.2 | |
| 12430 03...06 | 4-Hex bit | 3; 4; 5; 6 mm | |
| 12230 1...2 | 2-Pozidriv bit | PZ.1; PZ.2 | |

| Part no. | Socket | 2/20.6/21.6/1.54' | 10.3kg |
|----------------|-------------------------------------|---|--------|
| 41101 | | | |
| 1/2"DR. | | | |
| 545 10...32 | 18-6pt. Flank socket | 10; 11; 12; 13; 14; 15; 16; 17; 18; 19; 20; 21; 22; 23; 24; 27; 30; 32 mm | |
| 546 10...24 | 8-Star socket | E10; E11; E12; E14; E16; E18; E20; E24 | |
| 80243 | 1-24 teeth Ratchet handle | | |
| 8044 075...250 | 2-Extension 3"; 10" | | |
| 8014380 | 1-Swivel handle 15" | | |
| 80541 | 1-Universal joint | | |
| 8074 16...20.6 | 2-Spark plug socket 16; 20.6 mm | | |
| 81045 | 1-Bit holder 1/2"(F)x5/16"(F) | | |
| 15470 07...14 | 5-Hex bit | 7; 8; 10; 12; 14 mm | |
| 15330 08...12 | 3-Slotted bit | 8; 10; 12 mm | |
| 15130 3...4 | 2-Phillips bit | PH.3; PH.4 | |
| 15230 3...4 | 2-Pozidriv bit | PZ.3; PZ.4 | |
| 15630 40...55 | 4-Star bit | T40; T45; T50; T55 | |
| Other: | | | |
| 755 06...27 | 16-Combination wrench | 6; 7; 8; 9; 10; 11; 12; 13; 14; 15; 16; 17; 19; 22; 24; 27 mm | |
| 613B250 | 1-Waterpump pliers 10" | | |
| 611B175 | 1-Combination pliers 7" | | |
| 616300 | 1-Engineer hammer 300g | | |
| 7112S | 1-Stubby phillips screwdriver | PH.2(25mmL) | |
| 713065S | 1-Stubby slotted screwdriver | 6.5mm(25mmL) | |
| 7112 | 1-Phillips screwdriver PH.2(100mmL) | | |
| 713065 | 1-Slotted screwdriver 6.5mm(150mmL) | | |

NEW



139pc Combination set

| 41391 | Socket | 2/22.6/23.6/1.54' | 11.3kg |
|--------------------------|--------------------------------|---|--------|
| Part no. | Socket | 2/22.6/23.6/1.54' | 11.3kg |
| Content: 1/4" & 1/2" DR. | | | |
| 1/4"DR. | | | |
| 525 04...13 | 10-6pt. Flank socket | 4; 5; 6; 7; 8; 9; 10; 11; 12; 13 mm | |
| 80222 | 1-Ratchet handle 24th | | |
| 8042 050...100 | 2-Extension 2"; 4" | | |
| 80521 | 1-Universal joint | | |
| 8111 | 1-Flexible extension | | |
| 8143 | 1-Spinner 6" | | |
| 81022 | 1-Bit holder 1/4"(F)x1/4"inhex | | |
| 8032115 | 1-Sliding T handle 115mmL | | |
| 12330 04...065 | 3-Slotted bit | 4; 5.5; 6.5 mm | |
| 12630 08...30 | 7-Star bit | T8; T10; T15; T20; T25; T27; T30 | |
| 12130 0...2 | 3-Phillips bit | PH.0; PH.1; PH.2 | |
| 12430 03...08 | 5-Hex bit | 3; 4; 5; 6; 8 mm | |
| 12230 1...2 | 2-Pozidriv bit | PZ.1; PZ.2 | |
| 1/2"DR. | | | |
| 545 10...32 | 18-6pt. Flank socket | 10; 11; 12; 13; 14; 15; 16; 17; 18; 19; 20; 21; 22; 23; 24; 27; 30; 32 mm | |
| 80243 | 1-24 teeth Ratchet handle | | |
| 8044 075...250 | 2-Extension 3"; 10" | | |
| 8014380 | 1-Swivel handle 15" | | |
| 80541 | 1-Universal joint | | |

| 41391 | Socket | 2/22.6/23.6/1.54' | 11.3kg |
|-----------------|-------------------------------------|---|--------|
| Part no. | Socket | 2/22.6/23.6/1.54' | 11.3kg |
| 8074 16...20.6 | 2-Spark plug socket 16; 20.6 mm | | |
| 81045 | 1-Bit holder 1/2"(F)x5/16"(F) | | |
| 15470 04...12 | 7-Hex bit (70mmL) | 4; 5; 6; 7; 8; 10; 12 mm | |
| 15330 08...12 | 3-Slotted bit | 8; 10; 12 mm | |
| 15130 3...4 | 2-Phillips bit | PH.3; PH.4 | |
| 15230 3...4 | 2-Pozidriv bit | PZ.3; PZ.4 | |
| 15630 40...55 | 4-Star bit | T40; T45; T50; T55 | |
| Others: | | | |
| 755 06...27 | 16-Combination wrench | 6; 7; 8; 9; 10; 11; 12; 13; 14; 15; 16; 17; 19; 22; 24; 27 mm | |
| 6806 | 1-Multi-purpose crimping tool | | |
| 680T26 | 26pc Terminal pack | | |
| 613B250 | 1-Waterpump pliers 10" | | |
| 611B175 | 1-Combination pliers 7" | | |
| 60219200 | 1-Chisel 19(200mmL) | | |
| 60225220 | 1-Chisel 25(220mmL) | | |
| 6074185 | 1-Center punch 4(185mmL) | | |
| 604 2140...5200 | 4-Pin punch | 2(140mmL); 3(150mmL); 4(190mmL); 5(200mmL) | |
| 616300 | 1-Engineer hammer 300g | | |
| 7112S | 1-Stubby Phillips screwdriver | PH.2(25mmL) | |
| 713065S | 1-Stubby slotted screwdriver | 6.5mm(25mmL) | |
| 7112 | 1-Phillips screwdriver PH.2(100mmL) | | |
| 713065 | 1-Slotted screwdriver 6.5mm(150mmL) | | |



142pc Combination Set

| 41421 | Socket | 2/26.0/27.0/1.54' | 13kg |
|--------------------------------|---|---|------|
| Part no. | Socket | 2/26.0/27.0/1.54' | 13kg |
| Content: 1/4" & 3/8" & 1/2"DR. | | | |
| 1/4"DR. Part: | | | |
| 26-1/4" bit (30mmL) | | | |
| 12130 0...3 | Phillips PH.0; PH.1; PH.2; PH.3 | | |
| 12230 0...3 | Pozidriv PZ.0; PZ.1; PZ.2; PZ.3 | | |
| 12330 04...07 | Slotted 4; 5.5; 7 mm | | |
| 12430 02...10 | Hex 2; 3; 4; 5; 6; 7; 8; 10 mm | | |
| 12730 10...40 | Star tamperproof T-10H; T15H; T-20H; T-25H; T-27H; T-30H; T-40H | | |
| 525 04...10 | 9-6pt. Flank socket | 4; 4.5; 5; 5.5; 6; 7; 8; 9; 10 mm | |
| 526 04...08 | 5-Star socket | E4; E5; E6; E7; E8 mm | |
| 80222 | 1-24 teeth ratchet | | |
| 8042 050...150 | 3-Extension bar 2"; 4"; 6" | | |
| 80521 | 1-Universal joint | | |
| 80632 | 1- Adaptor for Extension | 3/8"(F) x 1/4"(M) | |
| 81022 | 1-Bit holder | | |
| 8111 | 1-Flexible extension | | |
| 8143 | 1-Spinner 6" | | |
| 3/8"DR. Part: | | | |
| 539 06...22 | 15-12pt. Flank socket | 6; 7; 8; 9; 10; 11; 12; 13; 14; 15; 17; 18; 19; 21; 22 mm | |
| 802318 | 1-Flexible ratchet | | |
| 8043 075...150 | 2-Extension bar 3"; 6" | | |
| 80531 | 1-Universal joint | | |

| 41421 | Socket | 2/26.0/27.0/1.54' | 13kg |
|--------------------------------|------------------------------------|--|------|
| Part no. | Socket | 2/26.0/27.0/1.54' | 13kg |
| 1/2"DR. Part: | | | |
| 545 08...32 | 19-6pt. Flank socket | 8; 10; 12; 13; 14; 15; 16; 17; 18; 19; 20; 21; 22; 23; 24; 25; 27; 30; 32 mm | |
| 546 10...20 | 5-Star socket | E10; E12; E14; E16; E20 mm | |
| 8014430 | 1-Swivel handle 17" (430mmL) | | |
| 80243 | 1-24 teeth thin ratchet | | |
| 8044 075...250 | 2-Extension bar 3" ; 10" | | |
| 80541 | 1-Universal joint | | |
| 80634 | 1-Adaptor for Extension | 3/8"(F) x 1/2"(M) | |
| 8074 16...20.6 | 2-Spark plug socket 16 ; 20.6 mm | | |
| 8154260 | 1-L handle 260mmL | | |
| Others: | | | |
| 755 06...24 | 17-Combination wrench | 6; 7; 8; 9; 10; 11; 12; 13; 14; 15; 16; 17; 18; 19; 21; 22; 24 mm | |
| 751 0810...1719 | 5-Flare nut wrench | 8x10; 10x12; 11x13; 12x14; 17x19 mm | |
| 764 025...14 | 10-Hex key | 2.5; 3; 4; 5; 6; 7; 8; 10; 12; 14 mm | |
| 616300 | 1-Engineering hammer 300gw | | |
| 611B175 | 1-Combination pliers 7" | | |
| 614250 | 1-Locking pliers 10" | | |
| 7111S | 1-Stubby phillips screwdriver PH.1 | | |
| 7112 | 1-Phillips screwdriver PH.2 | | |
| 7112M | 1-Hammer phillips screwdriver PH.2 | | |
| 713055S | 1-Stubby slotted screwdriver | 5.5mm x 25mmL | |
| 713065 | 1-Slotted screwdriver | 6.5mm x 150mmL | |
| 713065M | 1-Hammer slotted screwdriver | 6.5mm x 150mmL | |
| 41421-9 | | | |
| Part no. | Socket | 2/26.0/27.0/1.54' | 13kg |
| Changed Items | | | |
| Content: 1/4" & 3/8" & 1/2"DR. | | | |
| 1/4"DR. Part: | | | |
| 529 04...10 | 9-12pt. Flank socket | 4; 4.5; 5; 5.5; 6; 7; 8; 9; 10 mm | |
| 1/2"DR. Part: | | | |
| 549 08...32 | 19-12pt. Flank socket | 8; 10; 12; 13; 14; 15; 16; 17; 18; 19; 20; 21; 22; 23; 24; 25; 27; 30; 32 mm | |



163pc Socket set

| | | | |
|---------------|--------|-------------------------------------|--------|
| 41631S | | | |
| Part no. | Socket | 1/13.5/14.5/0.4' 1/6.0/8.0/1.25' | 19.5kg |

| | |
|-----------------------|---|
| 50141S 545 10...32 | 1-Short socket storage 163-6pt. Flank socket Each 13pcs - 10; 11; 12; 13; 14 mm Each 12pcs - 16; 17 mm Each 10pcs - 19; 21 mm Each 9pcs - 22; 23 mm Each 8pcs - 24; 26 mm Each 7pcs - 27; 30 mm Each 6pcs - 32 mm |
|-----------------------|---|

| | | | |
|-----------------|--------|-------------------------------------|--------|
| 41631S-7 | | | |
| Part no. | Socket | 1/13.5/14.5/0.4' 1/6.0/8.0/1.25' | 19.5kg |

| | |
|-----------------------|--|
| 50141S 547 10...32 | 1-Short socket storage 163-Surface drive socket Each 13pcs - 10; 11; 12; 13; 14 mm Each 12pcs - 16; 17 mm Each 10pcs - 19; 21 mm Each 9pcs - 22; 23 mm Each 8pcs - 24; 26 mm Each 7pcs - 27; 30 mm Each 6pcs - 32 mm |
|-----------------------|--|

| | | | |
|-----------------|--------|-------------------------------------|--------|
| 41631S-9 | | | |
| Part no. | Socket | 1/13.5/14.5/0.4' 1/6.0/8.0/1.25' | 19.5kg |

| | |
|-----------------------|--|
| 50141S 549 10...32 | 1-Short socket storage 163-12pt. Flank socket Each 13pcs - 10; 11; 12; 13; 14 mm Each 12pcs - 16; 17 mm Each 10pcs - 19; 21 mm Each 9pcs - 22; 23 mm Each 8pcs - 24; 26 mm Each 7pcs - 27; 30 mm Each 6pcs - 32 mm |
|-----------------------|--|

163pc Deep socket set

| | | | |
|---------------|--------|-------------------------------------|--------|
| 41631D | | | |
| Part no. | Socket | 1/36.0/37.0/1.2' 1/6.3/7.3/1.17' | 42.3kg |

| | |
|-------------------------|--|
| 50141D 54577 10...32 | 1-Deep socket storage 163-6pt. Flank socket Each 13pcs - 10; 11; 12; 13; 14 mm Each 12pcs - 16; 17 mm Each 10pcs - 19; 21 mm Each 9pcs - 22; 23 mm Each 8pcs - 24; 26 mm Each 7pcs - 27; 30 mm Each 6pcs - 32 mm |
|-------------------------|--|

| | | | |
|-----------------|--------|-------------------------------------|--------|
| 41631D-7 | | | |
| Part no. | Socket | 1/36.0/37.0/1.2' 1/6.3/7.3/1.17' | 42.3kg |

| | |
|-------------------------|---|
| 50141D 54777 10...32 | 1-Deep socket storage 163-Surface drive socket Each 13pcs - 10; 11; 12; 13; 14 mm Each 12pcs - 16; 17 mm Each 10pcs - 19; 21 mm Each 9pcs - 22; 23 mm Each 8pcs - 24; 26 mm Each 7pcs - 27; 30 mm Each 6pcs - 32 mm |
|-------------------------|---|

| | | | |
|-----------------|--------|-------------------------------------|--------|
| 41631D-9 | | | |
| Part no. | Socket | 1/36.0/37.0/1.2' 1/6.3/7.3/1.17' | 42.3kg |

| | |
|-------------------------|---|
| 50141D 54977 10...32 | 1-Deep socket storage 163-12pt. Flank socket Each 13pcs - 10; 11; 12; 13; 14 mm Each 12pcs - 16; 17 mm Each 10pcs - 19; 21 mm Each 9pcs - 22; 23 mm Each 8pcs - 24; 26 mm Each 7pcs - 27; 30 mm Each 6pcs - 32 mm |
|-------------------------|---|

3-Layer socket display shelf

| | | |
|--------------|----------------|--------|
| 50121 | | |
| Part no. | 1/12.4/13.4/2' | 12.4kg |

With 20pcs short partitions
With 20pcs medium partitions
With 15pcs long partitions

3-layer socket display shelf with 429pc tools

| | |
|-------------------|--|
| 50121A-429 | |
|-------------------|--|

| | |
|-------------|---|
| 50121 | Content: 1-3-layer socket display shelf |
| 525 04...14 | 1/4"DR. Part: 130-6pt. Flank socket Each 10pcs - 4; 4.5; 5; 5.5; 6; 7; 8; 9; 10; 11; 12; 13; 14 mm |
| 535 08...19 | 3/8"DR. Part: 68-6pt. Flank socket Each 10pcs - 8; 10; 12; 13; 14 mm Each 9pcs - 17; 19 mm |
| 545 08...32 | 1/2"DR. Part: 231-6pt. Flank socket 20pcs - 21 mm Each 10pcs - 8; 9; 10; 11; 12; 13; 14; 15; 16; 17; 18; 19; 20; 22; 23; 24 mm Each 9pcs - 25; 26; 27 mm Each 8pcs - 28; 30; 32 mm |



3-layer socket display shelf with 460pc tools

50121B-460

| | |
|----------------|--|
| 50121 | Content: 1-3-layer socket display shelf 1/4"DR. Part: |
| 32432 03...08 | 60-Hex socket bit Each 10pcs - 3; 4; 5; 6; 7; 8 mm |
| 32632 08...40 | 80-Star socket bit Each 10pcs - T8; T10; T15; T20; T25; T27; T30; T40 1/2"DR. Part: |
| 344055 07...12 | 109-Hex socket bit Each 10pcs - 7; 8; 10; 12 mm |
| 34406514 | 10pcs -14 mm (65mmL) |
| 344070 17...19 | Each 10pcs - 17; 19 mm (70mmL) |
| 344100 06...12 | Each 10pcs - 6; 8; 10 mm (100mmL) Each 9pcs - 12 mm (100mmL) |
| 346055 45...70 | 88-Star socket bit Each 10pcs- T45; T50; T55; T60; T70 |
| 34607080 | 10pcs - T80 (70mmL) |
| 346100 40...70 | Each 10pcs - T40 (100mmL) Each 9pcs - T60; T70 (100mmL) |
| 348055 06...14 | 123-Spline socket bit Each 10pcs - M6; M8; M10; M12; M14 |
| 34805516T | 10pcs - M16 |
| 348100 08...18 | Each 10pcs - M8; M9; M10 (100mmL) Each 9pcs - M12; M14 (100mmL) Each 7pcs - M18 (100mmL) |
| 34810016T | Each 8pcs - M16 (100mmL) |

3-layer socket display shelf with 408pc tools (SAE)

50121C-408

| | |
|-----------------|--|
| 50121 | Content: 1-3-layer socket display shelf 1/4"DR. Part: |
| 525 5.32...9.16 | 130-6pt. Flank socket Each 10pcs - 5/32"; 3/16"; 7/32"; 1/4"; 9/32"; 5/16"; 11/32; 3/8"; 13/32"; 7/16"; 15/32"; 1/2"; 9/16" |
| 545 1.4...1.1.4 | 1/2"DR. Part: 192-6pt. Flank socket Each 10pcs - 1/4"; 5/16"; 3/8"; 7/16"; 15/32"; 1/2"; 9/16"; 19/32"; 5/8"; 11/16"; 3/4"; 25/32"; 13/16"; 7/8"; 15/16"; |
| 54577 3.8...1.0 | Each 9pcs - 1"; 1-1/16" Each 8pcs - 1-1/8"; 1-3/16"; 1-1/4" 86-6pt. Flank deep socket Each 10pcs - 3/8"; 1/2"; 9/16"; 5/8" Each 9pcs - 11/16" Each 8pcs- 3/4"; 13/16" Each 7pcs - 7/8"; 15/16"; 1" |



23pc CabinBox Main set

| | | | |
|----------------|--|------------------|-------|
| 4234A | | | |
| Part no. | Socket | 4/16.5/17.5/0.9' | 4125g |
| 545 10...32 | Content: 1/2"DR. 18-6pt. Flank socket 10; 11; 12; 13; 14; 15; 16; 17; 18; 19; 20; 21; 22; 23; 24; 27; 30; 32 mm | | |
| 80249 | 1-72 teeth ratchet handle | | |
| 8044 125...250 | 2-Extension bar 5"; 10" | | |
| 80541 | 1-Universal joint | | |
| 80634 | 1-Adaptor for extension 3/8"(F)x1/2"(M) | | |



4234A+2421 CabinBox set

| | | | |
|-------------------|---|------------------|-------|
| 4234A+2421 | | | |
| Part no. | Socket | 4/20.1/21.1/0.9' | 5025g |
| 545 10...32 | 4234A Content: 1/2"DR. 18-6pt. Flank socket 10; 11; 12; 13; 14; 15; 16; 17; 18; 19; 20; 21; 22; 23; 24; 27; 30; 32 mm | | |
| 80249 | 1-72 teeth ratchet handle | | |
| 8044 125...250 | 2-Extension bar 5"; 10" | | |
| 80541 | 1-Universal joint | | |
| 80634 | 1-Adaptor for extension 3/8"(F)x1/2"(M) | | |
| 525 032...14 | 2421 Content: 1/4"DR. 14-6pt. Flank socket 3.2; 4; 4.5; 5; 5.5; 6; 7; 8; 9; 10; 11; 12; 13; 14 mm 20-1/4" Bit 25mmL | | |
| 12425 03...08 | Hex 3, 4, 5, 6, 8 mm | | |
| 12625 10...40 | Star T10, T15, T20, T25, T30, T40 | | |
| 12325 04...065 | Slotted 4, 5.5, 6.5 mm | | |
| 12125 1...3 | Phillips PH.1, PH.2, PH.3 | | |
| 12225 1...3 | Pozidriv PZ.1, PZ.2, PZ.3 | | |
| 80229 | 1-72 teeth ratchet handle | | |
| 8042 050...150 | 2-Extension bar 2"; 6" | | |
| 80521 | 1-Universal joint | | |
| 81022 | 1-Bit holder 1/4"(F)x1/4"(F) | | |
| 8143 | 1-Spinner 6" | | |
| 80632 | 1-Adaptor for extension 3/8"(F)x1/4"(M) | | |
| 81225 | 1-Magnetic socket pick up | | |



4234A+4102 23pc CabinBox Main set

| Part no. | Socket | 4/20.1/21.1/0.9' | 5225g |
|----------------|--|------------------|-------|
| 545 10...32 | 4234A Content: 1/2"DR. 18-6pt. Flank socket 10; 11; 12; 13; 14; 15; 16; 17; 18; 19; 20; 21; 22; 23; 24; 27; 30; 32 mm | | |
| 80249 | 1-72 teeth ratchet handle | | |
| 8044 125...250 | 2-Extension bar 5"; 10" | | |
| 80541 | 1-Universal joint | | |
| 80634 | 1-Adaptor for extension 3/8"(F)x1/2"(M) | | |
| 346055 20...60 | 4102 Content: 1/2"DR. 9-Star socket bit T20; T25; T27; T30; T40; T45; T50; T55; T60 (55mmL) | | |



23pc CabinBox Main set

| Part no. | Socket | 3/13.5/14.5/1' | 4500g |
|----------------|--|----------------|-------|
| 545 10...32 | Content: 1/2"DR. 18-6pt. Flank socket 10; 11; 12; 13; 14; 15; 16; 17; 18; 19; 20; 21; 22; 23; 24; 27; 30; 32 mm | | |
| 80249 | 1-72 teeth ratchet handle | | |
| 8044 125...250 | 2-Extension bar 5"; 10" | | |
| 80541 | 1-Universal joint | | |
| 80634 | 1-Adaptor for extension 3/8"(F)x1/2"(M) | | |



4234B+2641 CabinBox set

| Part no. | Socket | 3/19.0/20.0/1' | 7000g |
|----------------|--|----------------|-------|
| 545 10...32 | 4234B Content: 1/2"DR. 18-6pt. Flank socket 10; 11; 12; 13; 14; 15; 16; 17; 18; 19; 20; 21; 22; 23; 24; 27; 30; 32 mm | | |
| 80249 | 1-72 teeth ratchet handle | | |
| 8044 125...250 | 2-Extension bar 5"; 10" | | |
| 80541 | 1-Universal joint | | |
| 80634 | 1-Adaptor for extension 3/8"(F)x1/2"(M) | | |
| 525 032...14 | 2641 Content: 1/4"DR. 14-6pt. Flank socket 3.2; 4; 4.5; 5; 5.5; 6; 7; 8; 9; 10; 11; 12; 13; 14 mm | | |
| 52550 05...13 | 9-6pt. Flank deep socket 5; 6; 7; 8; 9; 10; 11; 12; 13 mm | | |
| 32432 03...10 | 24-Socket bit(32mmL) Hex 3; 4; 5; 6; 7; 8; 10 mm | | |
| 32132 1...3 | Phillips PH.1; PH.2; PH.3 | | |
| 32232 1...3 | Pozidriv PZ.1; PZ.2; PZ.3 | | |
| 32332 04...065 | Slotted 4; 5.5; 6.5 mm | | |
| 32632 08...40 | Star T8; T10; T15; T20; T25; T27; T30; T40 | | |
| 80229 | 1-72 teeth Ratchet handle | | |
| 8042 050...150 | 3-Extension bar 2"; 4"; 6" | | |
| 8032115 | 1-Sliding T handle | | |
| 80521 | 1-Universal joint | | |
| 8143 | 1-Spinner 6" | | |
| 81225 | 1-Magnetic socket pick-up | | |
| 5102XLB | 10-Hex ball point extra long key 1.27; 1.5; 2; 2.5; 3; 4; 5; 6; 8; 10 mm | | |
| 7650127XL... | | | |
| 10XL | | | |



4234B+3251-5 CabinBox set

| Part no. | Socket | 3/21.0/22.0/1' | 7000g |
|----------------|--|----------------|-------|
| 545 10...32 | 4234B Content: 1/2"DR. 18-6pt. Flank socket 10; 11; 12; 13; 14; 15; 16; 17; 18; 19; 20; 21; 22; 23; 24; 27; 30; 32 mm | | |
| 80249 | 1-72 teeth ratchet handle | | |
| 8044 125...250 | 2-Extension bar 5"; 10" | | |
| 80541 | 1-Universal joint | | |
| 80634 | 1-Adaptor for extension 3/8"(F)x1/2"(M) | | |
| 535 06...22 | 3251-5 Content: 3/8" DR. 17-6pt. Flank socket 6; 7; 8; 9; 10; 11; 12; 13; 14; 15; 16; 17; 18; 19; 20; 21; 22 mm | | |
| 80232 | 1-Ratchet handle | | |
| 8043 075...150 | 2-Extension bar 3"; 6" | | |
| 80531 | 1-Universal joint | | |
| 8033165 | 1-Sliding T handle | | |
| 8073 16...20.6 | 2-Spark plug socket 16mm; 20.6mm | | |



4234B+3361 CabinBox set

| Part no. | Socket | 3/23.8/24.8/1' | 7910g |
|----------------|--|----------------|-------|
| 545 10...32 | 4234B Content: 1/2"DR. 18-6pt. Flank socket 10; 11; 12; 13; 14; 15; 16; 17; 18; 19; 20; 21; 22; 23; 24; 27; 30; 32 mm | | |
| 80249 | 1-72 teeth ratchet handle | | |
| 8044 125...250 | 2-Extension bar 5"; 10" | | |
| 80541 | 1-Universal joint | | |
| 80634 | 1-Adaptor for extension 3/8"(F)x1/2"(M) | | |



4234B+4411 CabinBox set

| Part no. | Socket | 3/21.5/22.5/1' | 6966g |
|----------------|--|----------------|-------|
| 545 10...32 | 4234B Content: 1/2"DR. 18-6pt. Flank socket 10; 11; 12; 13; 14; 15; 16; 17; 18; 19; 20; 21; 22; 23; 24; 27; 30; 32 mm | | |
| 80249 | 1-72 teeth ratchet handle | | |
| 8044 125...250 | 2-Extension bar 5"; 10" | | |
| 80541 | 1-Universal joint | | |
| 80634 | 1-Adaptor for extension 3/8"(F)x1/2"(M) | | |



4234B+5161 CabinBox set

| Part no. | Socket | 3/20.5/21.5/1' | 6833g |
|----------------|--|----------------|-------|
| 545 10...32 | 4234B Content: 1/2"DR. 18-6pt. Flank socket 10; 11; 12; 13; 14; 15; 16; 17; 18; 19; 20; 21; 22; 23; 24; 27; 30; 32 mm | | |
| 80249 | 1-72 teeth ratchet handle | | |
| 8044 125...250 | 2-Extension bar 5"; 10" | | |
| 80541 | 1-Universal joint | | |
| 80634 | 1-Adaptor for extension 3/8"(F)x1/2"(M) | | |



24pc CabinBox Main set

| Part no. | Socket | 3/15.5/16.5/1' | 5230g |
|----------------|--|----------------|-------|
| 545 10...32 | Content: 1/2"DR. 18-6pt. Flank socket 10; 11; 12; 13; 14; 15; 16; 17; 18; 19; 20; 21; 22; 23; 24; 27; 30; 32 mm | | |
| 80249 | 1-72 teeth ratchet handle | | |
| 8014380 | 1-Swivel handle 15" | | |
| 8044 125...250 | 2-Extension bar 5"; 10" | | |
| 80541 | 1-Universal joint | | |
| 80634 | 1-Adaptor for extension 3/8"(F)x1/2"(M) | | |

| | | | |
|----------------|--|--|--|
| 535 06...22 | 3361 Content: 3/8" DR. 17-6pt. Flank socket 6; 7; 8; 9; 10; 11; 12; 13; 14; 15; 16; 17; 18; 19; 20; 21; 22 mm | | |
| 80239 | 1-72 teeth ratchet handle | | |
| 8043 075...225 | 3-Extension bar 3"; 6"; 9" | | |
| 8073 16...20.6 | 2-Spark plug socket 16; 20.6 mm | | |
| 80531 | 1-Universal joint | | |
| 80643 | 3-Adaptor for extension 1/2"(F)x3/8"(M) | | |
| 755 07...17 | 11-Combination wrench 7, 8, 9, 10, 11, 12, 13, 14, 15, 16, 17 mm | | |

| | | | |
|---------------|--|--|--|
| 766 09...70 | 4411 Content: 1/4" & 3/8" & 1/2" DR. 19-Star L key T9; T10; T15; T20; T25; T27; T30; T40; T45; T50; T55; T60; T70 | | |
| 12630 09...20 | 4-1/4" star bit (30mmL) T9; T10; T15; T20 | | |
| 17630 25...50 | 6-10mm star bit (30mmL) T25; T27; T30; T40; T45; T50 | | |
| 17611555 | 1-10mm star bit T55 (115mmL) | | |
| 19675 60...70 | 2-14mm star bit (75mmL) T60; T70 | | |
| 526 04...08 | 5-1/4"DR. star socket E4; E5; E6; E7; E8 | | |
| 536 10...20 | 7-3/8"DR. star socket E10; E11; E12; E14; E16; E18; E20 | | |
| 810 22...414 | 3-Bit holder 1/4"DR.x1/4"; 3/8"DR.x10mm; 1/2"DR.x14mm | | |

| | | | |
|-------------|--|--|--|
| 755 06...24 | 5161 Content: 16-Combination wrench 6; 7; 8; 9; 10; 11; 12; 13; 14; 15; 16; 17; 18; 19; 22; 24 mm | | |
|-------------|--|--|--|



4243B+2203-72-5 CabinBox set

| 4243B+ 2203-72-5 | | | |
|-----------------------------|--|----------------|-------|
| Part no. | Socket | 3/18.8/19.8/1' | 6290g |
| 545 10...32 | 4243B Content: 1/2"DR. 18-6pt. Flank socket 10; 11; 12; 13; 14; 15; 16; 17; 18; 19; 20; 21; 22; 23; 24; 27; 30; 32 mm | | |
| 80249 | 1-72 teeth ratchet handle | | |
| 8014380 | 1-Swivel handle 15" | | |
| 8044 125...250 | 2-Extension bar 5"; 10" | | |
| 80541 | 1-Universal joint | | |
| 80634 | 1-Adaptor for extension 3/8"(F)x1/2"(M) | | |
| 525 04...14 | 2203-72-5 Content: 1/4"DR. 13-6pt. Flank socket 4; 4.5; 5; 5.5; 6; 7; 8; 9; 10; 11; 12; 13; 14 mm | | |
| 80229 | 1-72 teeth ratchet handle | | |
| 8042 050...150 | 2-Extension bar 2"; 6" | | |
| 80521 | 1-Universal joint | | |
| 8032115 | 1-Sliding T handle | | |
| 8145 | 1-Spinner | | |

4243B+2253-72 CabinBox set

| 4243B+ 2253-72 | | | |
|---------------------------|--|----------------|-------|
| Part no. | Socket | 3/20.0/21.0/1' | 6660g |
| 545 10...32 | 4243B Content: 1/2"DR. 18-6pt. Flank socket 10; 11; 12; 13; 14; 15; 16; 17; 18; 19; 20; 21; 22; 23; 24; 27; 30; 32 mm | | |
| 80249 | 1-72 teeth ratchet handle | | |
| 8014380 | 1-Swivel handle 15" | | |
| 8044 125...250 | 2-Extension bar 5"; 10" | | |
| 80541 | 1-Universal joint | | |
| 80634 | 1-Adaptor for extension 3/8"(F)x1/2"(M) | | |
| 525 04...13 | 2253-72 Content: 1/4"DR. 11-6pt. Flank socket 4; 5; 5.5; 6; 7; 8; 9; 10; 11; 12; 13 mm | | |
| 52550 05...13 | 9-6pt. Flank deep socket 5; 6; 7; 8; 9; 10; 11; 12; 13 mm | | |
| 80229 | 1-72 teeth ratchet handle | | |
| 8042 050...150 | 2-Extension bar 2"; 6" | | |
| 8143 | 1-Spinner 6" | | |

4243B+2281-72-5 CabinBox set

| 4243B+ 2281-72-5 | | | |
|-----------------------------|--|----------------|-------|
| Part no. | Socket | 3/19.6/20.6/1' | 6530g |
| 545 10...32 | 4243B Content: 1/2"DR. 18-6pt. Flank socket 10; 11; 12; 13; 14; 15; 16; 17; 18; 19; 20; 21; 22; 23; 24; 27; 30; 32 mm | | |
| 80249 | 1-72 teeth ratchet handle | | |
| 8014380 | 1-Swivel handle 15" | | |
| 8044 125...250 | 2-Extension bar 5"; 10" | | |
| 80541 | 1-Universal joint | | |
| 80634 | 1-Adaptor for extension 3/8"(F)x1/2"(M) | | |
| 525 04...14 | 2281-72-5 Content: 1/4"DR. 11-6pt. Flank socket 4; 5; 6; 7; 8; 9; 10; 11; 12; 13; 14 mm | | |
| 32432 03...06 | Hex 3; 4; 5; 6 mm | | |
| 32332 04...07 | Slotted 4; 5.5; 7 mm | | |
| 32132 1...3 | Phillips PH.1; PH.2; PH.3 | | |
| 80229 | 1-72 teeth ratchet handle | | |
| 8042 050...150 | 2-Extension bar 2"; 6" | | |
| 8032115 | 1-Sliding T handle | | |
| 80521 | 1-Universal joint | | |
| 8143 | 1-Spinner 6" | | |

4243B+2571 CabinBox set

| 4243B+ 2571 | | | |
|------------------------|--|-------------------|-------|
| Part no. | Socket | 3/19.9/20.9/0.95' | 6630g |
| 545 10...32 | 4243B Content: 1/2"DR. 18-6pt. Flank socket 10; 11; 12; 13; 14; 15; 16; 17; 18; 19; 20; 21; 22; 23; 24; 27; 30; 32 mm | | |
| 80249 | 1-72 teeth ratchet handle | | |
| 8014380 | 1-Swivel handle 15" | | |
| 8044 125...250 | 2-Extension bar 5"; 10" | | |
| 80541 | 1-Universal joint | | |
| 80634 | 1-Adaptor for extension 3/8"(F)x1/2"(M) | | |
| 525 04...14 | 2571 Content: 1/4"DR. 13-6pt. Flank socket 4; 4.5; 5; 5.5; 6; 7; 8; 9; 10; 11; 12; 13; 14 mm | | |
| 52550 06...10 | 4-6pt. Flank deep socket 6; 7; 8; 10 mm | | |
| 32132 1...3 | 24-Socket bit(32mmL) Phillips PH.1; PH.2; PH.3 | | |
| 32232 1...3 | Pozidriv PZ.1; PZ.2; PZ.3 | | |
| 32332 04...065 | Slotted 4; 5.5; 6.5 mm | | |
| 32432 03...10 | Hex 3; 4; 5; 6; 7; 8; 10 mm | | |
| 32632 08...40 | Star T8; T10; T15; T20; T25; T27; T30; T40 | | |
| 526 04...10 | 6-Star socket E4; E5; E6; E7; E8; E10 | | |
| 80229 | 1-72 teeth ratchet handle | | |
| 8032115 | 2-Sliding T handle | | |
| 8042 050...100 | 1-Extension bar 2"; 4" | | |
| 80521 | 1-Universal joint | | |
| 8143 | 1-Spinner 6" | | |
| 764 0127...025 | 4-Hex key 1.27; 1.5; 2; 2.5 mm | | |



10mm Hex bit

| 174 | | l | | |
|---------------------|------|----------|----|--------|
| Part no. | size | mm | g | pc/box |
| 1743004 | 4 | 30 | 13 | 10 |
| 1743005 | 5 | 30 | 14 | 10 |
| 1743006 | 6 | 30 | 14 | 10 |
| 1743007 | 7 | 30 | 16 | 10 |
| 1743008 | 8 | 30 | 17 | 10 |
| 1743009 NEW | 9 | 30 | 18 | 10 |
| 1743010 | 10 | 30 | 20 | 10 |
| 1743012 | 12 | 30 | 25 | 10 |
| 1743014 NEW | 14 | 30 | 27 | 10 |
| 1747504 | 4 | 75 | 43 | 10 |
| 1747505 | 5 | 75 | 43 | 10 |
| 1747506 | 6 | 75 | 44 | 10 |
| 1747507 | 7 | 75 | 45 | 10 |
| 1747508 | 8 | 75 | 47 | 10 |
| 1747509 NEW | 9 | 75 | 48 | 10 |
| 1747510 | 10 | 75 | 50 | 10 |
| 1747512 | 12 | 75 | 67 | 10 |
| 17412008 NEW | 8 | 120 | 80 | 10 |
| 17412010 NEW | 10 | 120 | 82 | 10 |

10mm Star bit

| 176 | | l | | |
|---------------------|------|----------|----|--------|
| Part no. | size | mm | g | pc/box |
| 1763050 | T50 | 30 | 16 | 10 |
| 1763055 | T55 | 30 | 18 | 10 |
| 1763060 | T60 | 30 | 22 | 10 |
| 1767510 | T10 | 75 | 41 | 10 |
| 1767515 | T15 | 75 | 41 | 10 |
| 1767520 | T20 | 75 | 42 | 10 |
| 1767525 | T25 | 75 | 42 | 10 |
| 1767527 | T27 | 75 | 42 | 10 |
| 1767530 | T30 | 75 | 43 | 10 |
| 1767535 NEW | T35 | 75 | 44 | 10 |
| 1767540 | T40 | 75 | 44 | 10 |
| 1767545 | T45 | 75 | 45 | 10 |
| 1767550 | T50 | 75 | 45 | 10 |
| 1767555 | T55 | 75 | 48 | 10 |
| 1767560 | T60 | 75 | 64 | 10 |
| 17611555 NEW | T55 | 115 | 70 | 10 |
| 17612040 NEW | T40 | 120 | 72 | 10 |
| 17612045 NEW | T45 | 120 | 72 | 10 |
| 17612050 NEW | T50 | 120 | 74 | 10 |
| 17612055 NEW | T55 | 120 | 74 | 10 |



10mm Star tamperproof bit

| 177 | | l | | |
|------------|-------|----------|----|--------|
| Part no. | size | mm | g | pc/box |
| 1773010 | T-10H | 30 | 14 | 10 |
| 1773015 | T-15H | 30 | 14 | 10 |
| 1773020 | T-20H | 30 | 14 | 10 |
| 1773025 | T-25H | 30 | 14 | 10 |
| 1773027 | T-27H | 30 | 14 | 10 |
| 1773030 | T-30H | 30 | 14 | 10 |
| 1773040 | T-40H | 30 | 14 | 10 |
| 1773045 | T-45H | 30 | 16 | 10 |
| 1773050 | T-50H | 30 | 16 | 10 |
| 1773055 | T-55H | 30 | 18 | 10 |
| 1773060 | T-60H | 30 | 22 | 10 |
| 1777510 | T-10H | 75 | 42 | 10 |
| 1777515 | T-15H | 75 | 42 | 10 |
| 1777520 | T-20H | 75 | 42 | 10 |
| 1777525 | T-25H | 75 | 42 | 10 |
| 1777527 | T-27H | 75 | 42 | 10 |
| 1777530 | T-30H | 75 | 42 | 10 |
| 1777540 | T-40H | 75 | 44 | 10 |
| 1777545 | T-45H | 75 | 44 | 10 |
| 1777550 | T-50H | 75 | 46 | 10 |
| 1777555 | T-55H | 75 | 48 | 10 |
| 1777560 | T-60H | 75 | 66 | 10 |

10mm Spline bit

| 178 | | l | | |
|--------------------|------|----------|-----|--------|
| Part no. | size | mm | g | pc/box |
| 1783005 | M5 | 30 | 13 | 10 |
| 1783006 | M6 | 30 | 14 | 10 |
| 1783007 NEW | M7 | 30 | 14 | 10 |
| 1783008 | M8 | 30 | 15 | 10 |
| 1783009 NEW | M9 | 30 | 16 | 10 |
| 1783010 | M10 | 30 | 17 | 10 |
| 1783012 | M12 | 30 | 20 | 10 |
| 1783014 NEW | M14 | 30 | 25 | 10 |
| 1787504 NEW | M4 | 75 | 43 | 10 |
| 1787505 | M5 | 75 | 43 | 10 |
| 1787506 | M6 | 75 | 43 | 10 |
| 1787507 NEW | M7 | 75 | 43 | 10 |
| 1787508 | M8 | 75 | 44 | 10 |
| 1787509 NEW | M9 | 75 | 46 | 10 |
| 1787510 | M10 | 75 | 47 | 10 |
| 1787512 | M12 | 75 | 58 | 10 |
| 1787514 | M14 | 75 | 80 | 10 |
| 17812008 | M8 | 120 | 74 | 10 |
| 17812010 | M10 | 120 | 77 | 10 |
| 17812012 | M12 | 120 | 106 | 10 |



10mm Star bit

| 176 | | l | | |
|--------------------|------|----------|----|--------|
| Part no. | size | mm | g | pc/box |
| 1763010 | T10 | 30 | 12 | 10 |
| 1763015 | T15 | 30 | 12 | 10 |
| 1763020 | T20 | 30 | 13 | 10 |
| 1763025 | T25 | 30 | 13 | 10 |
| 1763027 | T27 | 30 | 14 | 10 |
| 1763030 | T30 | 30 | 14 | 10 |
| 1763035 NEW | T35 | 30 | 14 | 10 |
| 1763040 | T40 | 30 | 15 | 10 |
| 1763045 | T45 | 30 | 16 | 10 |
| 1763047 | T47 | 30 | 20 | 10 |

14mm Star bit

| 196 | | l | | |
|------------|------|----------|----|--------|
| Part no. | size | mm | g | pc/box |
| 1965060 | T60 | 50 | 56 | 10 |
| 1965070 | T70 | 50 | 60 | 10 |
| 1967560 | T60 | 75 | 88 | 10 |
| 1967570 | T70 | 75 | 93 | 10 |



10mm Ribbe bit

| 179 | | | | |
|----------|------|----|----|--------|
| Part no. | size | mm | g | pc/box |
| 1793004 | M4 | 30 | 14 | 10 |
| 1793005 | M5 | 30 | 14 | 10 |
| 1793006 | M6 | 30 | 14 | 10 |
| 1793007 | M7 | 30 | 14 | 10 |
| 1793008 | M8 | 30 | 14 | 10 |
| 1793009 | M9 | 30 | 18 | 10 |
| 1793012 | M12 | 30 | 20 | 10 |
| 1793013 | M13 | 30 | 22 | 10 |
| 1793014 | M14 | 30 | 24 | 10 |
| 1797504 | M4 | 75 | 42 | 10 |
| 1797505 | M5 | 75 | 42 | 10 |
| 1797506 | M6 | 75 | 42 | 10 |
| 1797507 | M7 | 75 | 42 | 10 |
| 1797508 | M8 | 75 | 44 | 10 |
| 1797509 | M9 | 75 | 46 | 10 |
| 1797510 | M10 | 75 | 47 | 10 |
| 1797512 | M12 | 75 | 63 | 10 |
| 1797513 | M13 | 75 | 78 | 10 |
| 1797514 | M14 | 75 | 79 | 10 |



1/2" Pozidriv socket bit

| 342 | | | | |
|----------|------|----|----|--------|
| Part no. | size | mm | g | pc/box |
| 342552 | PZ.2 | 55 | 65 | 10 |
| 342553 | PZ.3 | 55 | 65 | 10 |
| 342554 | PZ.4 | 55 | 70 | 10 |



1/2" Slotted socket bit (one-piece)

| 343 | | | | |
|----------|------|----|----|--------|
| Part no. | size | mm | g | pc/box |
| 34313 | 13 | 38 | 77 | 10 |
| 34319 | 19 | 38 | 84 | 10 |
| 34324 | 24 | 38 | 86 | 10 |



1/2" Phillips socket bit

| 341 | | | | |
|----------|------|----|----|--------|
| Part no. | size | mm | g | pc/box |
| 341552 | PH.2 | 55 | 63 | 10 |
| 341553 | PH.3 | 55 | 65 | 10 |
| 341554 | PH.4 | 55 | 70 | 10 |



1/2" Slotted socket bit

| 343 | | | | |
|----------|----------|----|-----|--------|
| Part no. | size | mm | g | pc/box |
| 3435508 | 1.2 x 8 | 55 | 70 | 10 |
| 3435509 | 1.6 x 9 | 55 | 70 | 10 |
| 3435510 | 1.6 x 10 | 55 | 70 | 10 |
| 3435511 | 1.8 x 11 | 55 | 92 | 10 |
| 3435512 | 2.0 x 12 | 55 | 102 | 10 |
| 3435514 | 2.5 x 14 | 55 | 112 | 10 |
| 3435516 | 2.5 x 16 | 55 | 112 | 10 |



1/2" Hex socket bit (one-piece)

| 344 | | | | |
|----------|------|----|-----|--------|
| Part no. | size | mm | g | pc/box |
| 34404 | 4 | 38 | 56 | 10 |
| 34405 | 5 | 38 | 56 | 10 |
| 34406 | 6 | 38 | 58 | 10 |
| 34407 | 7 | 38 | 59 | 10 |
| 34408 | 8 | 38 | 71 | 10 |
| 34410 | 10 | 40 | 76 | 10 |
| 34412 | 12 | 40 | 83 | 10 |
| 34414 | 14 | 40 | 91 | 10 |
| 34417 | 17 | 42 | 103 | 10 |
| 34419 | 19 | 42 | 112 | 10 |



1/2" Hex socket bit

| 344 | | | | |
|------------|-------|----|-----|--------|
| Part no. | size | mm | g | pc/box |
| 34405504 | 4 | 55 | 62 | 10 |
| 34405505 | 5 | 55 | 64 | 10 |
| 34405506 | 6 | 55 | 65 | 10 |
| 34405507 | 7 | 55 | 68 | 10 |
| 34405508 | 8 | 55 | 69 | 10 |
| 34405509 | 9 | 55 | 79 | 10 |
| 34405510 | 10 | 55 | 80 | 10 |
| 34405512 | 12 | 55 | 103 | 10 |
| 34406514 | 14 | 65 | 149 | 10 |
| 34407017 | 17 | 70 | 196 | 10 |
| 34407019 | 19 | 70 | 235 | 10 |
| 3440555.32 | 5/32" | 55 | 63 | 10 |
| 3440553.16 | 3/16" | 55 | 63 | 10 |
| 3440557.32 | 7/32" | 55 | 63 | 10 |
| 3440551.4 | 1/4" | 55 | 63 | 10 |
| 3440555.16 | 5/16" | 55 | 69 | 10 |
| 3440553.8 | 3/8" | 55 | 79 | 10 |
| 3440557.16 | 7/16" | 55 | 102 | 10 |
| 3440551.2 | 1/2" | 55 | 112 | 10 |
| 3440659.16 | 9/16" | 65 | 150 | 10 |
| 3440655.8 | 5/8" | 65 | 154 | 10 |
| 3440703.4 | 3/4" | 70 | 242 | 10 |

| 344 | | | | |
|-------------------------|------|-----|-----|--------|
| Part no. | size | mm | g | pc/box |
| 34407006 | 6 | 70 | 70 | 10 |
| 34408006 | 6 | 80 | 75 | 10 |
| 34408008 | 8 | 80 | 80 | 10 |
| 34410004 ^{NEW} | 4 | 100 | 69 | 10 |
| 34410005 | 5 | 100 | 78 | 10 |
| 34410006 | 6 | 100 | 78 | 10 |
| 34410007 | 7 | 100 | 87 | 10 |
| 34410008 | 8 | 100 | 88 | 10 |
| 34410009 ^{NEW} | 9 | 100 | 104 | 10 |
| 34410010 | 10 | 100 | 108 | 10 |
| 34410011 | 11 | 100 | 144 | 10 |
| 34410012 | 12 | 100 | 145 | 10 |
| 34410013 | 13 | 100 | 148 | 10 |
| 34410014 | 14 | 100 | 197 | 10 |
| 34411005 | 5 | 110 | 85 | 10 |
| 34411006 | 6 | 110 | 85 | 10 |
| 34411007 | 7 | 110 | 91 | 101 |
| 34411008 | 8 | 110 | 93 | 0 |
| 34411010 | 10 | 110 | 117 | 10 |
| 34411012 | 12 | 110 | 162 | 10 |
| 34411014 | 14 | 110 | 207 | 10 |
| 34411017 | 17 | 110 | 274 | 10 |
| 34411019 | 19 | 110 | 331 | 10 |
| 34412008 | 8 | 120 | 100 | 10 |
| 34413008 | 8 | 130 | 105 | 10 |
| 34414006 | 6 | 140 | 89 | 10 |
| 34414008 | 8 | 140 | 104 | 10 |
| 34414010 | 10 | 140 | 139 | 10 |
| 34414012 | 12 | 140 | 186 | 10 |
| 34414014 | 14 | 140 | 245 | 10 |
| 34415007 ^{NEW} | 7 | 150 | 103 | 10 |
| 34416006 | 6 | 160 | 95 | 10 |
| 34418005 | 5 | 180 | 120 | 10 |
| 34419008 | 8 | 190 | 130 | 10 |
| 34422006 | 6 | 220 | 115 | 10 |
| 34424806 | 6 | 248 | 125 | 10 |

* 34410011: for VW-Audi, Seat, Skoda petrol engines. to remove and replace the plastic insert for injector valves.

* 34410013: for VW-Audi, Seat, Skoda 4 Cylinder TDI PD engines. To loosen and fasten of the central retaining bolt of Fuel Cooling Unit, example to replace the Fuel filter.

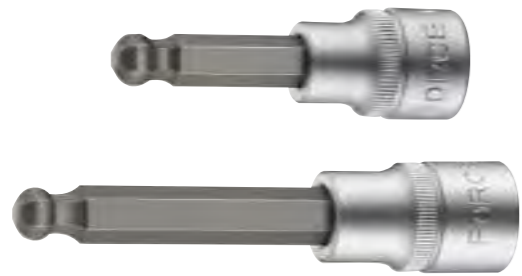

1/2" Hex ball point socket bit

| 345 | | <i>l</i> | | |
|------------|------|----------|-----|--------|
| Part no. | size | mm | g | pc/box |
| 34510005 | 5 | 100 | 76 | 10 |
| 34510006 | 6 | 100 | 80 | 10 |
| 34510008 | 8 | 100 | 88 | 10 |
| 34510010 | 10 | 100 | 108 | 10 |
| 34524005 | 5 | 240 | 125 | 10 |
| 34524008 | 8 | 240 | 130 | 10 |



1/2" Star socket bit (one-piece)

| 346 | | <i>l</i> | | |
|------------|------|----------|----|--------|
| Part no. | size | mm | g | pc/box |
| 34620 | T20 | 37 | 63 | 10 |
| 34625 | T25 | 37 | 63 | 10 |
| 34627 | T27 | 37 | 68 | 10 |
| 34630 | T30 | 37 | 68 | 10 |
| 34640 | T40 | 37 | 68 | 10 |
| 34645 | T45 | 37 | 70 | 10 |
| 34647 | T47 | 37 | 71 | 10 |
| 34650 | T50 | 40 | 72 | 10 |
| 34655 | T55 | 40 | 75 | 10 |
| 34660 | T60 | 40 | 77 | 10 |

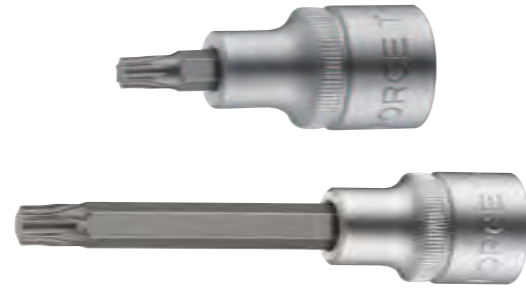

1/2" Star socket bit

| 346 | | <i>l</i> | | |
|------------|----------------|----------|-----|--------|
| Part no. | size | mm | g | pc/box |
| 34605520 | T20 | 55 | 62 | 10 |
| 34605525 | T25 | 55 | 63 | 10 |
| 34605527 | T27 | 55 | 63 | 10 |
| 34605530 | T30 | 55 | 63 | 10 |
| 34605535 | NEW T35 | 55 | 63 | 10 |
| 34605540 | T40 | 55 | 64 | 10 |
| 34605545 | T45 | 55 | 67 | 10 |
| 34605547 | T47 | 55 | 67 | 10 |
| 34605550 | T50 | 55 | 68 | 10 |
| 34605555 | T55 | 55 | 79 | 10 |
| 34605560 | T60 | 55 | 101 | 10 |
| 34605570 | T70 | 55 | 132 | 10 |
| 34607080 | T80 | 70 | 185 | 10 |
| 34610020 | T20 | 100 | 74 | 10 |
| 34610025 | T25 | 100 | 74 | 10 |
| 34610027 | T27 | 100 | 75 | 10 |
| 34610030 | T30 | 100 | 76 | 10 |
| 34610040 | T40 | 100 | 76 | 10 |
| 34610045 | T45 | 100 | 86 | 10 |
| 34610050 | T50 | 100 | 87 | 10 |
| 34610055 | T55 | 100 | 108 | 10 |
| 34610060 | T60 | 100 | 146 | 10 |
| 34610070 | T70 | 100 | 191 | 10 |
| 34610080 | T80 | 100 | 246 | 10 |
| 34610090 | T90 | 100 | 299 | 5 |
| 346100100 | T100 | 100 | 350 | 5 |
| 34611050R | T50 | 110 | 121 | 10 |
| 34612040 | T40 | 120 | 90 | 10 |
| 34612045 | T45 | 120 | 100 | 10 |
| 34612070 | T70 | 120 | 211 | 10 |
| 34614045 | T45 | 140 | 103 | 10 |
| 34614050 | T50 | 140 | 104 | 10 |

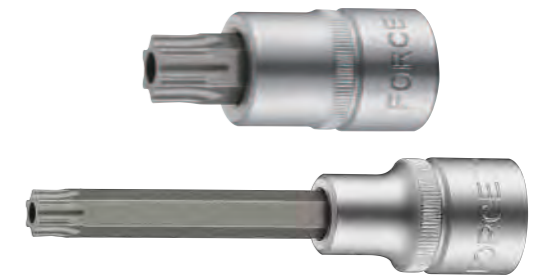

1/2" Star tamperproof socket bit

| 347 | | <i>l</i> | | |
|------------|--------|----------|-----|--------|
| Part no. | size | mm | g | pc/box |
| 34705520 | T-20H | 55 | 62 | 10 |
| 34705525 | T-25H | 55 | 62 | 10 |
| 34705527 | T-27H | 55 | 62 | 10 |
| 34705530 | T-30H | 55 | 62 | 10 |
| 34705540 | T-40H | 55 | 64 | 10 |
| 34705545 | T-45H | 55 | 68 | 10 |
| 34705550 | T-50H | 55 | 68 | 10 |
| 34705555 | T-55H | 55 | 78 | 10 |
| 34705560 | T-60H | 55 | 104 | 10 |
| 34705570 | T-70H | 55 | 131 | 10 |
| 34707080 | T-80H | 70 | 139 | 10 |
| 34710020 | T-20H | 100 | 76 | 10 |
| 34710025 | T-25H | 100 | 76 | 10 |
| 34710027 | T-27H | 100 | 76 | 10 |
| 34710030 | T-30H | 100 | 76 | 10 |
| 34710040 | T-40H | 100 | 76 | 10 |
| 34710045 | T-45H | 100 | 85 | 10 |
| 34710050 | T-50H | 100 | 87 | 10 |
| 34710055 | T-55H | 100 | 108 | 10 |
| 34710060 | T-60H | 100 | 143 | 10 |
| 34710070 | T-70H | 100 | 189 | 10 |
| 34710080 | T-80H | 100 | 238 | 10 |
| 34710090 | T-90H | 100 | 296 | 5 |
| 347100100 | T-100H | 100 | 346 | 5 |
| 34710570 | T-70H | 105 | 168 | 10 |
| 34712070 | T-70H | 120 | 212 | 10 |
| 34713030 | T-30H | 130 | 85 | 10 |
| 34714055 | T-55H | 140 | 137 | 10 |
| 34714090 | T-90H | 140 | 392 | 5 |
| 347140100 | T-100H | 140 | 461 | 5 |

| 346 | | <i>l</i> | | |
|------------|------|----------|-----|--------|
| Part no. | size | mm | g | pc/box |
| 34614055 | T55 | 140 | 138 | 10 |
| 34614060 | T60 | 140 | 184 | 10 |
| 34614070 | T70 | 140 | 198 | 10 |
| 34614090 | T90 | 140 | 233 | 5 |
| 346140100 | T100 | 140 | 241 | 5 |
| 34620030 | T30 | 200 | 110 | 10 |
| 34620040 | T40 | 200 | 110 | 10 |
| 34620045 | T45 | 200 | 135 | 10 |
| 34620050 | T50 | 200 | 138 | 10 |

* 34611050R bit is made by 10mm round steel, be applied in alternator of vehicle.(see no.678)

* 34707080 : For removal and replacement of the wind screen wiper arm and adjusting the pressure on BMW E31, E38 AND E39.

* 34713030 T-30H 130mmL
To remove and replace the screws on airbag of BMW, Mercedes, VW, Audi.

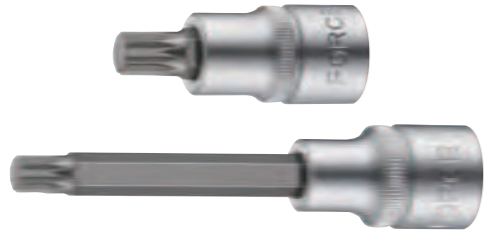

1/2" Spline socket bit

| 348 | | | | |
|---------------------|------|-----|-----|--------|
| Part no. | size | mm | g | pc/box |
| 34805505 | M5 | 55 | 67 | 10 |
| 34805506 | M6 | 55 | 67 | 10 |
| 34805508 | M8 | 55 | 67 | 10 |
| 34805509 | M9 | 55 | 77 | 10 |
| 34805510 | M10 | 55 | 78 | 10 |
| 34805512 | M12 | 55 | 100 | 10 |
| 34805514 | M14 | 55 | 131 | 10 |
| 34805516 | M16 | 55 | 162 | 10 |
| | | | | |
| 34810005 | M5 | 100 | 80 | 10 |
| 34810006 | M6 | 100 | 85 | 10 |
| 34810008 | M8 | 100 | 87 | 10 |
| 34810009 | M9 | 100 | 95 | 10 |
| 34810010 | M10 | 100 | 108 | 10 |
| 34810012 | M12 | 100 | 151 | 10 |
| 34810014 | M14 | 100 | 187 | 10 |
| 34810016 | M16 | 100 | 242 | 10 |
| 34810018 NEW | M18 | 100 | 305 | 10 |
| | | | | |
| 34811010 NEW | M10 | 110 | 113 | 10 |
| 34811012 NEW | M12 | 110 | 160 | 10 |
| 34811014 NEW | M14 | 110 | 205 | 10 |
| 34811016 NEW | M16 | 110 | 234 | 10 |
| | | | | |
| 34811010R | M10 | 110 | 121 | 10 |
| | | | | |
| 34812008 | M8 | 120 | 95 | 10 |
| 34812009 | M9 | 120 | 121 | 10 |
| 34812010 | M10 | 120 | 121 | 10 |
| | | | | |
| 34814008 | M8 | 140 | 110 | 10 |
| 34814009 | M9 | 140 | 140 | 10 |
| 34814010 | M10 | 140 | 140 | 10 |
| 34814012 | M12 | 140 | 152 | 10 |
| 34814014 | M14 | 140 | 256 | 10 |
| | | | | |
| 34880008 | M8 | 800 | 610 | 10 |
| 34880010 | M10 | 800 | 616 | 10 |

* 34880008, 34880010
Special 800mm length provides access to Axle Shafts for removal & replacement on AUDI/VW vehicles
* 34811010R bit is made by 10mm round steel, be applied in alternator of vehicle.(see no.674)

1/2" DR. Spline Security socket bit

| 348..T | | | | |
|----------------------|------|-----|-----|--------|
| Part no. | size | mm | g | pc/box |
| 34805514T NEW | M14 | 55 | 130 | 10 |
| 34805516T | M16 | 55 | 142 | 10 |
| 34810016T | M16 | 100 | 270 | 10 |

* For removal and replacement of the gear box drain plug Audi A3,A4,A6;VW Golf IV,LT.

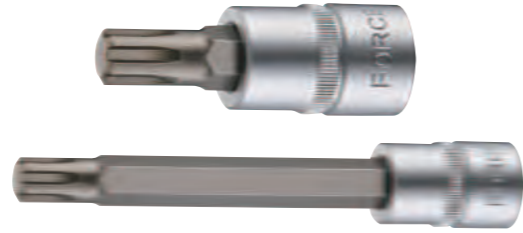

1/2" Ribe socket bit

| 349 | | | | |
|---------------------|------|-----|-----|--------|
| Part no. | size | mm | g | pc/box |
| 34905506 | M6 | 55 | 70 | 10 |
| 34906306 NEW | M6 | 63 | 68 | 10 |
| 34910005 | M5 | 100 | 82 | 10 |
| 34910006 | M6 | 100 | 82 | 10 |
| 34910007 | M7 | 100 | 82 | 10 |
| 34910008 | M8 | 100 | 82 | 10 |
| 34910009 | M9 | 100 | 106 | 10 |
| 34910010 | M10 | 100 | 122 | 10 |
| 34910012 | M12 | 100 | 150 | 10 |
| 34910013 | M13 | 100 | 185 | 10 |
| 34910014 | M14 | 100 | 187 | 10 |
| 34910016 | M16 | 100 | 237 | 10 |
| | | | | |
| 34912009 | M9 | 120 | 148 | 10 |
| | | | | |
| 34914008 | M8 | 140 | 102 | 10 |
| 34914009 NEW | M9 | 140 | 134 | 10 |
| 34914010 | M10 | 140 | 136 | 10 |
| 34914012 | M12 | 140 | 178 | 10 |
| 34914014 | M14 | 140 | 286 | 10 |
| 34914010V | M10 | 140 | 134 | 10 |
| | | | | |
| 34924806 | M6 | 248 | 125 | 10 |
| 34924807 | M7 | 248 | 149 | 10 |
| 34924808 | M8 | 248 | 150 | 10 |

Ribe socket bit :
* To remove and fasten cylinder-head retaining bolts on FIAT engines.
* 34914010V
Special for Audi engines, and VW-Passat cylinder head screws.

NEW

1/2" Ribe tamperproof socket bit

| 349..T | | | | |
|---------------|------|----|-----|--------|
| Part no. | size | mm | g | pc/box |
| 34906305T | M5 | 63 | 66 | 10 |
| 34906306T | M6 | 63 | 68 | 10 |
| 34906307T | M7 | 63 | 68 | 10 |
| 34906308T | M8 | 63 | 68 | 10 |
| 34906309T | M9 | 63 | 81 | 10 |
| 34906310T | M10 | 63 | 81 | 10 |
| 34906312T | M12 | 63 | 113 | 10 |
| 34906314T | M14 | 63 | 140 | 10 |
| 34906316T | M16 | 63 | 177 | 10 |



1/2" DR. 6pt. Flank socket

| 545 | | | | |
|-------------------|--------|----|-----|--------|
| Part no. | Socket | mm | g | pc/box |
| 54505 NEW | 5 | 38 | 53 | 10 |
| 505055 NEW | 5.5 | 38 | 53 | 10 |
| 54506 NEW | 6 | 38 | 52 | 10 |
| 54507 NEW | 7 | 38 | 52 | 10 |
| 54508 | 8 | 38 | 50 | 10 |
| 54509 | 9 | 38 | 50 | 10 |
| 54510 | 10 | 38 | 52 | 10 |
| 54511 | 11 | 38 | 52 | 10 |
| 54512 | 12 | 38 | 53 | 10 |
| 54513 | 13 | 38 | 53 | 10 |
| 54514 | 14 | 38 | 55 | 10 |
| 54515 | 15 | 38 | 55 | 10 |
| 54516 | 16 | 38 | 59 | 10 |
| 54517 | 17 | 38 | 65 | 10 |
| 54518 | 18 | 38 | 78 | 10 |
| 54519 | 19 | 38 | 79 | 10 |
| 54520 | 20 | 38 | 81 | 10 |
| 54521 | 21 | 38 | 95 | 10 |
| 54522 | 22 | 38 | 96 | 10 |
| 54523 | 23 | 40 | 116 | 10 |
| 54524 | 24 | 40 | 117 | 10 |
| 54525 | 25 | 43 | 119 | 10 |

| 545 | | | | |
|-------------------|---------|----|-----|--------|
| Part no. | Socket | mm | g | pc/box |
| 54526 | 26 | 43 | 138 | 10 |
| 54527 | 27 | 43 | 144 | 10 |
| 54528 | 28 | 43 | 162 | 10 |
| 54529 | 29 | 43 | 162 | 10 |
| 54530 | 30 | 45 | 173 | 10 |
| 54531 | 31 | 45 | 174 | 10 |
| 54532 | 32 | 45 | 176 | 10 |
| 54533 NEW | 33 | 47 | 265 | 10 |
| 54534 NEW | 34 | 47 | 267 | 10 |
| 54535 NEW | 35 | 48 | 267 | 10 |
| 54536 NEW | 36 | 48 | 266 | 10 |
| | | | | |
| 5451.4 NEW | 1/4" | 38 | 45 | 10 |
| 5455.16 | 5/16" | 38 | 50 | 10 |
| 5453.8 | 3/8" | 38 | 53 | 10 |
| 5457.16 | 7/16" | 38 | 53 | 10 |
| 54515.32 | 15/32" | 38 | 53 | 10 |
| 5451.2 | 1/2" | 38 | 54 | 10 |
| 5459.16 | 9/16" | 38 | 55 | 10 |
| 54519.32 | 19/32" | 38 | 55 | 10 |
| 5455.8 | 5/8" | 38 | 60 | 10 |
| 54511.16 | 11/16" | 38 | 63 | 10 |
| 5453.4 | 3/4" | 38 | 70 | 10 |
| 54525.32 | 25/32" | 38 | 79 | 10 |
| 54513.16 | 13/16" | 38 | 79 | 10 |
| 5457.8 | 7/8" | 38 | 96 | 10 |
| 54515.16 | 15/16" | 40 | 109 | 10 |
| 5451.0 | 1" | 43 | 140 | 10 |
| 5451.1.16 | 1-1/16" | 43 | 144 | 10 |
| 5451.1.8 | 1-1/8" | 45 | 147 | 10 |
| 5451.3.16 | 1-3/16" | 45 | 168 | 10 |
| 5451.1.4 | 1-1/4" | 45 | 184 | 10 |



1/2" DR. 6pt. Flank deep socket

| 54577 | | <i>l</i> | | |
|--------------|--------|----------|-----|--------|
| Part no. | Socket | mm | g | pc/box |
| 5457708 | 8 | 77 | 73 | 10 |
| 5457709 | 9 | 77 | 77 | 10 |
| 5457710 | 10 | 77 | 79 | 10 |
| 5457711 | 11 | 77 | 81 | 10 |
| 5457712 | 12 | 77 | 86 | 10 |
| 5457713 | 13 | 77 | 94 | 10 |
| 5457714 | 14 | 77 | 105 | 10 |
| 5457715 | 15 | 77 | 111 | 10 |
| 5457716 | 16 | 77 | 122 | 10 |
| 5457717 | 17 | 77 | 132 | 10 |
| 5457718 | 18 | 77 | 157 | 10 |
| 5457719 | 19 | 77 | 163 | 10 |
| 5457720 | 20 | 77 | 171 | 10 |
| 5457721 | 21 | 77 | 207 | 10 |
| 5457722 | 22 | 77 | 220 | 10 |
| 5457723 | 23 | 77 | 236 | 10 |
| 5457724 | 24 | 77 | 243 | 10 |
| 5457725 | 25 | 77 | 254 | 10 |
| 5457726 | 26 | 77 | 289 | 10 |
| 5457727 | 27 | 77 | 297 | 10 |
| 5457728 | 28 | 77 | 317 | 10 |
| 5457729 | 29 | 77 | 333 | 10 |
| 5457730 | 30 | 77 | 352 | 10 |
| 5457731 | 31 | 77 | 384 | 10 |
| 5457732 | 32 | 77 | 420 | 10 |

| 54577 | | <i>l</i> | | |
|--------------|---------|----------|-----|--------|
| Part no. | Socket | mm | g | pc/box |
| 545775.16 | 5/16" | 77 | 77 | 10 |
| 545773.8 | 3/8" | 77 | 79 | 10 |
| 545777.16 | 7/16" | 77 | 81 | 10 |
| 545771.2 | 1/2" | 77 | 94 | 10 |
| 545779.16 | 9/16" | 77 | 105 | 10 |
| 545775.8 | 5/8" | 77 | 122 | 10 |
| 5457711.16 | 11/16" | 77 | 132 | 10 |
| 545773.4 | 3/4" | 77 | 163 | 10 |
| 5457713.16 | 13/16" | 77 | 207 | 10 |
| 545777.8 | 7/8" | 77 | 220 | 10 |
| 5457715.16 | 15/16" | 77 | 243 | 10 |
| 545771.0 | 1" | 77 | 254 | 10 |
| 545771.1.16 | 1-1/16" | 77 | 297 | 10 |
| 545771.1.8 | 1-1/8" | 77 | 333 | 10 |
| 545771.3.16 | 1-3/16" | 77 | 384 | 10 |
| 545771.1.4 | 1-1/4" | 77 | 420 | 10 |



1/2" DR. Star socket

| 546 | | <i>l</i> | | |
|------------|--------|----------|-----|--------|
| Part no. | Socket | mm | g | pc/box |
| 54608 | E8 | 38 | 50 | 10 |
| 54610 | E10 | 38 | 52 | 10 |
| 54611 | E11 | 38 | 52 | 10 |
| 54612 | E12 | 38 | 5 | 10 |
| 54614 | E14 | 38 | 55 | 10 |
| 54616 | E16 | 38 | 57 | 10 |
| 54618 | E18 | 38 | 59 | 10 |
| 54620 | E20 | 38 | 64 | 10 |
| 54622 | E22 | 38 | 85 | 10 |
| 54624 | E24 | 40 | 100 | 10 |



1/2" DR. Star Deep socket

| 54677 | | <i>l</i> | | |
|----------------------------|--------|----------|-----|--------|
| Part no. | Socket | mm | g | pc/box |
| 5467708 <small>NEW</small> | E8 | 77 | 65 | 10 |
| 5467710 | E10 | 77 | 84 | 10 |
| 5467711 | E11 | 77 | 88 | 10 |
| 5467712 | E12 | 77 | 93 | 10 |
| 5467714 | E14 | 77 | 98 | 10 |
| 5467716 | E16 | 77 | 119 | 10 |
| 5467718 | E18 | 77 | 129 | 10 |
| 5467720 | E20 | 77 | 171 | 10 |
| 5467722 <small>NEW</small> | E22 | 77 | 186 | 10 |
| 5467724 | E24 | 77 | 227 | 10 |



1/2" DR. Surface drive socket

| 547 | | <i>l</i> | | |
|--------------------------|---------|----------|-----|--------|
| Part no. | Socket | mm | g | pc/box |
| 54708 | 8 | 38 | 50 | 10 |
| 54709 | 9 | 38 | 50 | 10 |
| 54710 | 10 | 38 | 51 | 10 |
| 54711 | 11 | 38 | 51 | 10 |
| 54712 | 12 | 38 | 51 | 10 |
| 54713 | 13 | 38 | 53 | 10 |
| 54714 | 14 | 38 | 55 | 10 |
| 54715 | 15 | 38 | 58 | 10 |
| 54716 | 16 | 38 | 58 | 10 |
| 54717 | 17 | 38 | 63 | 10 |
| 54718 | 18 | 38 | 77 | 10 |
| 54719 | 19 | 38 | 79 | 10 |
| 54720 | 20 | 38 | 79 | 10 |
| 54721 | 21 | 38 | 94 | 10 |
| 54722 | 22 | 38 | 94 | 10 |
| 54723 | 23 | 40 | 103 | 10 |
| 54724 | 24 | 40 | 109 | 10 |
| 54725 <small>NEW</small> | 25 | 42 | 114 | 10 |
| 54726 | 26 | 43 | 121 | 10 |
| 54727 | 27 | 43 | 139 | 10 |
| 54728 | 28 | 43 | 146 | 10 |
| 54729 <small>NEW</small> | 29 | 43 | 153 | 10 |
| 54730 | 30 | 45 | 167 | 10 |
| 54732 | 32 | 45 | 176 | 10 |
| 5475.16 | 5/16" | 38 | 50 | 10 |
| 5473.8 | 3/8" | 38 | 51 | 10 |
| 5477.16 | 7/16" | 38 | 51 | 10 |
| 54715.32 | 15/32" | 38 | 51 | 10 |
| 5471.2 | 1/2" | 38 | 53 | 10 |
| 5479.16 | 9/16" | 38 | 55 | 10 |
| 54719.32 | 19/32" | 38 | 58 | 10 |
| 5475.8 | 5/8" | 38 | 58 | 10 |
| 54711.16 | 11/16" | 38 | 63 | 10 |
| 5473.4 | 3/4" | 38 | 77 | 10 |
| 54725.32 | 25/32" | 38 | 79 | 10 |
| 54713.16 | 13/16" | 38 | 79 | 10 |
| 5477.8 | 7/8" | 38 | 94 | 10 |
| 54715.16 | 15/16" | 40 | 103 | 10 |
| 5471.0 | 1" | 43 | 118 | 10 |
| 5471.1.16 | 1-1/16" | 43 | 139 | 10 |
| 5471.1.8 | 1-1/8" | 45 | 152 | 10 |
| 5471.3.16 | 1-3/16" | 45 | 167 | 10 |
| 5471.1.4 | 1-1/4" | 45 | 174 | 10 |

NEW



1/2" DR. Star deep socket

| 546150...B | | <i>l</i> | | |
|-------------------|--------|----------|-----|--------|
| Part no. | Socket | mm | g | pc/box |
| 54615010B | E10 | 150 | 152 | 10 |
| 54615012B | E12 | 150 | 153 | 10 |
| 54615014B | E14 | 150 | 155 | 10 |
| 54615016B | E16 | 150 | 158 | 10 |
| 54615018B | E18 | 150 | 160 | 10 |
| 54615020B | E20 | 150 | 163 | 10 |



1/2" DR. Surface drive deep socket

| Part no. | Socket | mm | g | pc/box |
|----------------------------|--------|----|-----|--------|
| 5477708 | 8 | 77 | 73 | 10 |
| 5477709 | 9 | 77 | 77 | 10 |
| 5477710 | 10 | 77 | 79 | 10 |
| 5477711 | 11 | 77 | 81 | 10 |
| 5477712 | 12 | 77 | 86 | 10 |
| 5477713 | 13 | 77 | 94 | 10 |
| 5477714 | 14 | 77 | 105 | 10 |
| 5477715 | 15 | 77 | 111 | 10 |
| 5477716 | 16 | 77 | 122 | 10 |
| 5477717 | 17 | 77 | 132 | 10 |
| 5477718 | 18 | 77 | 157 | 10 |
| 5477719 | 19 | 77 | 163 | 10 |
| 5477720 | 20 | 77 | 171 | 10 |
| 5477721 | 21 | 77 | 207 | 10 |
| 5477722 | 22 | 77 | 220 | 10 |
| 5477723 | 23 | 77 | 236 | 10 |
| 5477724 | 24 | 77 | 243 | 10 |
| 5477725 <small>NEW</small> | 25 | 77 | 250 | 10 |
| 5477726 | 26 | 77 | 289 | 10 |
| 5477727 | 27 | 77 | 297 | 10 |
| 5477728 | 28 | 77 | 317 | 10 |
| 5477729 <small>NEW</small> | 29 | 77 | 304 | 10 |
| 5477730 | 30 | 77 | 352 | 10 |
| 5477732 | 32 | 77 | 420 | 10 |



1/2" DR. 12pt. WW Flank socket

| Part no. | Socket | mm | g | pc/box |
|----------|--------|----|-----|--------|
| 548W3.16 | 3/16" | 38 | 50 | 10 |
| 548W1.4 | 1/4" | 38 | 52 | 10 |
| 548W5.16 | 5/16" | 38 | 52 | 10 |
| 548W3.8 | 3/8" | 38 | 72 | 10 |
| 548W7.16 | 7/16" | 38 | 86 | 10 |
| 548W1.2 | 1/2" | 40 | 102 | 10 |
| 548W9.16 | 9/16" | 43 | 110 | 10 |
| 548W5.8 | 5/8" | 45 | 146 | 10 |
| 548W3.4 | 3/4" | 45 | 230 | 10 |



1/2" DR. 12pt. Flank socket

| Part no. | Socket | mm | g | pc/box |
|----------|--------|----|----|--------|
| 54908 | 8 | 38 | 51 | 10 |
| 54909 | 9 | 38 | 51 | 10 |
| 54910 | 10 | 38 | 51 | 10 |
| 54911 | 11 | 38 | 52 | 10 |
| 54912 | 12 | 38 | 52 | 10 |
| 54913 | 13 | 38 | 52 | 10 |
| 54914 | 14 | 38 | 54 | 10 |
| 54915 | 15 | 38 | 53 | 10 |
| 54916 | 16 | 38 | 58 | 10 |



1/2" DR. 12pt. Flank deep socket

| Part no. | Socket | mm | g | pc/box |
|--------------------------------|---------|----|-----|--------|
| 5497708 | 8 | 77 | 71 | 10 |
| 5497709 | 9 | 77 | 71 | 10 |
| 5497710 | 10 | 77 | 71 | 10 |
| 5497711 | 11 | 77 | 76 | 10 |
| 5497712 | 12 | 77 | 84 | 10 |
| 5497713 | 13 | 77 | 93 | 10 |
| 5497714 | 14 | 77 | 100 | 10 |
| 5497715 | 15 | 77 | 100 | 10 |
| 5497716 | 16 | 77 | 100 | 10 |
| 5497717 | 17 | 77 | 117 | 10 |
| 5497718 | 18 | 77 | 143 | 10 |
| 5497719 | 19 | 77 | 149 | 10 |
| 5497720 | 20 | 77 | 154 | 10 |
| 5497721 | 21 | 77 | 183 | 10 |
| 5497722 | 22 | 77 | 193 | 10 |
| 5497723 | 23 | 77 | 212 | 10 |
| 5497724 | 24 | 77 | 248 | 10 |
| 5497725 | 25 | 77 | 239 | 10 |
| 5497726 | 26 | 77 | 275 | 10 |
| 5497727 | 27 | 77 | 270 | 10 |
| 5497728 | 28 | 77 | 300 | 10 |
| 5497729 | 29 | 77 | 281 | 10 |
| 5497730 | 30 | 77 | 290 | 10 |
| 5497731 | 31 | 77 | 292 | 10 |
| 5497732 | 32 | 77 | 303 | 10 |
| 549775.16 <small>NEW</small> | 5/16" | 77 | 70 | 10 |
| 549773.8 <small>NEW</small> | 3/8" | 77 | 71 | 10 |
| 549777.16 <small>NEW</small> | 7/16" | 77 | 75 | 10 |
| 549771.2 <small>NEW</small> | 1/2" | 77 | 95 | 10 |
| 549779.16 <small>NEW</small> | 9/16" | 77 | 97 | 10 |
| 549775.8 <small>NEW</small> | 5/8" | 77 | 98 | 10 |
| 5497711.16 <small>NEW</small> | 11/16" | 77 | 121 | 10 |
| 549773.4 <small>NEW</small> | 3/4" | 77 | 148 | 10 |
| 5497713.16 <small>NEW</small> | 13/16" | 77 | 168 | 10 |
| 549777.8 <small>NEW</small> | 7/8" | 77 | 196 | 10 |
| 5497715.16 <small>NEW</small> | 15/16" | 77 | 220 | 10 |
| 549771.0 <small>NEW</small> | 1" | 77 | 241 | 10 |
| 549771.1.16 <small>NEW</small> | 1-1/16" | 77 | 270 | 10 |
| 549771.1.8 <small>NEW</small> | 1-1/8" | 77 | 301 | 10 |
| 549771.3.16 <small>NEW</small> | 1-3/16" | 77 | 292 | 10 |
| 549771.1.4 <small>NEW</small> | 1-1/4" | 77 | 307 | 10 |

| Part no. | Socket | mm | g | pc/box |
|---------------------------|---------|----|-----|--------|
| 54917 | 17 | 38 | 64 | 10 |
| 54918 | 18 | 38 | 80 | 10 |
| 54919 | 19 | 38 | 81 | 10 |
| 54920 | 20 | 38 | 86 | 10 |
| 54921 | 21 | 38 | 94 | 10 |
| 54922 | 22 | 38 | 94 | 10 |
| 54923 | 23 | 40 | 108 | 10 |
| 54924 | 24 | 40 | 108 | 10 |
| 54925 | 25 | 43 | 117 | 10 |
| 54926 | 26 | 43 | 124 | 10 |
| 54927 | 27 | 43 | 135 | 10 |
| 54928 | 28 | 43 | 138 | 10 |
| 54929 | 29 | 43 | 165 | 10 |
| 54930 | 30 | 45 | 168 | 10 |
| 54931 | 31 | 45 | 171 | 10 |
| 54932 | 32 | 45 | 176 | 10 |
| 5491.4 <small>NEW</small> | 1/4" | 38 | 44 | 10 |
| 5495.16 | 5/16" | 38 | 50 | 10 |
| 5493.8 | 3/8" | 38 | 51 | 10 |
| 5497.16 | 7/16" | 38 | 51 | 10 |
| 54915.32 | 15/32" | 38 | 51 | 10 |
| 5491.2 | 1/2" | 38 | 53 | 10 |
| 5499.16 | 9/16" | 38 | 55 | 10 |
| 54919.32 | 19/32" | 38 | 58 | 10 |
| 5495.8 | 5/8" | 38 | 58 | 10 |
| 54911.16 | 11/16" | 38 | 63 | 10 |
| 5493.4 | 3/4" | 38 | 77 | 10 |
| 54925.32 | 25/32" | 38 | 79 | 10 |
| 54913.16 | 13/16" | 38 | 79 | 10 |
| 5497.8 | 7/8" | 38 | 94 | 10 |
| 54915.16 | 15/16" | 40 | 103 | 10 |
| 5491.0 | 1" | 43 | 118 | 10 |
| 5491.1.16 | 1-1/16" | 43 | 139 | 10 |
| 5491.1.8 | 1-1/8" | 45 | 152 | 10 |
| 5491.3.16 | 1-3/16" | 45 | 167 | 10 |
| 5491.1.4 | 1-1/4" | 45 | 174 | 10 |

**1/2" DR. Spine socket**

| 54Q | | | | | | | | | | |
|------------------|------|--------|---------|---------|-------|-----|----------------|-------|------------|--|
| Part no. | size | 6point | 12point | SAE | E-Tox | XZN | <i>l</i> mm | g | pc/box | |
| 54Q08 | 8 | . | . | | E10 | | 38 | 44 | 10 | |
| 54Q09 | 9 | . | . | | E11 | | 38 | 44 | 10 | |
| 54Q10 | 10 | . | . | 3/8" | E12 | 10 | 38 | 46 | 10 | |
| 54Q11 | 11 | . | . | 7/16" | E14 | 11 | 38 | 46 | 10 | |
| 54Q12 | 12 | . | . | 15/32" | | 12 | 38 | 48 | 10 | |
| 54Q13 | 13 | . | . | 1/2" | E16 | | 38 | 50 | 10 | |
| 54Q14 | 14 | . | . | 9/16" | E18 | 14 | 38 | 52 | 10 | |
| 54Q15 | 15 | . | . | 19/32" | | | 38 | 56 | 10 | |
| 54Q16 | 16 | . | . | 5/8" | E20 | 16 | 38 | 58 | 10 | |
| 54Q17 | 17 | . | . | | | | 38 | 72 | 10 | |
| 54Q18 | 18 | . | . | | E22 | 18 | 38 | 78 | 10 | |
| 54Q19 | 19 | . | . | 3/4" | E24 | | 38 | 80 | 10 | |
| 54Q20 | 20 | . | . | 25/32" | | 20 | 38 | 82 | 10 | |
| 54Q21 | 21 | . | . | 13/16" | | | 38 | 82 | 10 | |
| 54Q22 | 22 | . | . | 7/8" | | 22 | 38 | 86 | 10 | |
| 54Q23 | 23 | . | . | | | | 40 | 100 | 10 | |
| 54Q24 | 24 | . | . | 15/16" | | 24 | 40 | 112 | 10 | |
| 54Q25 NEW | 25 | . | . | | | | 42 | 125 | 10 | |
| 54Q26 | 26 | . | . | | | | 42 | 140 | 10 | |
| 54Q27 | 27 | . | . | 1-1/16" | | | 43 | 170 | 10 | |
| 54Q28 | 28 | . | . | | | | 43 | 180 | 10 | |
| 54Q30 | 30 | . | . | 1-1/8" | | 30 | 45 | 210 | 10 | |
| 54Q32 | 32 | . | . | 1-1/4" | | 32 | 45 | 230 | 10 | |

**1/2" DR. Spine deep socket**

| 54Q77 | | | | | | | | | | |
|--------------|------|--------|---------|---------|-------|-----|----------------|-------|------------|--|
| Part no. | size | 6point | 12point | SAE | E-Tox | XZN | <i>l</i> mm | g | pc/box | |
| 54Q7708 | 8 | . | . | | E10 | | 77 | 100 | 10 | |
| 54Q7709 | 9 | . | . | | E11 | | 77 | 100 | 10 | |
| 54Q7710 | 10 | . | . | 3/8" | E12 | 10 | 77 | 100 | 10 | |
| 54Q7711 | 11 | . | . | 7/16" | E14 | 11 | 77 | 103 | 10 | |
| 54Q7712 | 12 | . | . | 15/32" | | 12 | 77 | 105 | 10 | |
| 54Q7713 | 13 | . | . | 1/2" | E16 | | 77 | 107 | 10 | |
| 54Q7714 | 14 | . | . | 9/16" | E18 | 14 | 77 | 118 | 10 | |
| 54Q7715 | 15 | . | . | 19/32" | | | 77 | 125 | 10 | |
| 54Q7716 | 16 | . | . | 5/8" | E20 | 16 | 77 | 140 | 10 | |
| 54Q7717 | 17 | . | . | | | | 77 | 150 | 10 | |
| 54Q7718 | 18 | . | . | | E22 | 18 | 77 | 165 | 10 | |
| 54Q7719 | 19 | . | . | 3/4" | E24 | | 77 | 178 | 10 | |
| 54Q7720 | 20 | . | . | 25/32" | | 20 | 77 | 180 | 10 | |
| 54Q7721 | 21 | . | . | 13/16" | | | 77 | 185 | 10 | |
| 54Q7722 | 22 | . | . | 7/8" | | 22 | 77 | 205 | 10 | |
| 54Q7723 | 23 | . | . | | | | 77 | 245 | 10 | |
| 54Q7724 | 24 | . | . | 15/16" | | 24 | 77 | 252 | 10 | |
| 54Q7726 | 26 | . | . | | | | 77 | 310 | 10 | |
| 54Q7727 | 27 | . | . | 1-1/16" | | | 77 | 345 | 10 | |
| 54Q7728 | 28 | . | . | | | | 77 | 365 | 10 | |
| 54Q7730 | 30 | . | . | 1-1/8" | | 30 | 77 | 400 | 10 | |
| 54Q7732 | 32 | . | . | 1-1/4" | | 32 | 77 | 410 | 10 | |

**1/2" DR. Swivel handle**

| 8014 | | | |
|-------------|----------------|-------|------------|
| Part no. | <i>l</i> mm | g | pc/box |
| 8014250 | 250-10" | 516 | 5 |
| 8014380 | 380-15" | 772 | 5 |
| 8014430 | 430-17" | 886 | 5 |

* Spare part available

**1/2" DR. Swivel handle**

| 8014600 | | | |
|----------------|----------------|-------|------------|
| Part no. | <i>l</i> mm | g | pc/box |
| 8014600 | 600-24" | 1400 | 12 |

* Spare part available

**1/2" DR. Ratchet handle-24 teeth-Thin**

| 80244 | | | |
|--------------|----------------|-------|------------|
| Part no. | <i>l</i> mm | g | pc/box |
| 80244 | 245 | 644 | 1 |

* Spare part available

**1/2" DR. Ratchet handle-36 teeth-RD**

| 80245 | | | |
|--------------|----------------|-------|------------|
| Part no. | <i>l</i> mm | g | pc/box |
| 80245 | 251 | 599.5 | 1 |

* Spare part available

**1/2" DR. Ratchet handle-24 teeth**

| 80242 | | | |
|--------------|----------------|-------|------------|
| Part no. | <i>l</i> mm | g | pc/box |
| 80242 | 270 | 754 | 1 |

* Spare part available

**1/2" DR. Ratchet handle-32 teeth**

| 80246 | | | |
|--------------|----------------|-------|------------|
| Part no. | <i>l</i> mm | g | pc/box |
| 80246 | 263 | 634 | 1 |

* Spare part available

**1/2" DR. Ratchet handle-24 teeth-Thin**

| 80243 | | | |
|--------------|----------------|-------|------------|
| Part no. | <i>l</i> mm | g | pc/box |
| 80243 | 255 | 618 | 1 |

* Spare part available

**1/2" DR. 72teeth Ratchet handle**

| 80249 | | | |
|--------------|----------------|-------|------------|
| Part no. | <i>l</i> mm | g | pc/box |
| 80249 | 264 | 524 | 1 |

* Spare part available



1/2" DR. Ratchet handle-24 teeth

| | | | |
|---------------|----------|----------|---------------|
| 802411 | l | g | pc/box |
| Part no. | mm | g | pc/box |
| 802411 | 260 | 832 | 1 |

* Spare part available



1/2" DR. Square hole ratchet handle

| | | | |
|---------------|----------|----------|---------------|
| 802412 | l | g | pc/box |
| Part no. | mm | g | pc/box |
| 802412 | 270 | 558 | 1 |

802412D(driver part)

* 1/2" Square driver is not included in ratchet handle, it's a optional item.



1/2" DR. Ratchet handle-36 teeth

| | | | |
|---------------|----------|----------|---------------|
| 802415 | l | g | pc/box |
| Part no. | mm | g | pc/box |
| 802415 | 240 | 636 | 1 |

* Spare part available



1/2" DR. Flexible ratchet handle

| | | | |
|---------------|----------|----------|---------------|
| 802418 | l | g | pc/box |
| Part no. | mm | g | pc/box |
| 802418 | 290 | 798 | 1 |
| 802418L | 427 | 1076 | 1 |

* Spare part available



1/2" DR. Gearless ratchet handle

| | | | |
|---------------|----------|----------|---------------|
| 802421 | l | g | pc/box |
| Part no. | mm | g | pc/box |
| 802421 | 240 | 624 | 1 |



1/2" DR. 72 teeth round ratchet handle

| | | | |
|---------------|----------|----------|---------------|
| 802422 | l | g | pc/box |
| Part no. | mm | g | pc/box |
| 802422 | 264 | 517 | 1 |

* Spare part available



1/2" DR. 72 teeth flexible round ratchet handle

| | | | |
|---------------|----------|----------|---------------|
| 802423 | l | g | pc/box |
| Part no. | mm | g | pc/box |
| 802423 | 303 | 656 | 1 |

* Spare part available



1/2" DR. Quick-release 72 teeth round ratchet handle

| | | | |
|---------------|----------|----------|---------------|
| 802424 | l | g | pc/box |
| Part no. | mm | g | pc/box |
| 802424 | 258 | 515 | 1 |

* Spare part available

NEW



1/2" DR. 45 teeth Stubby ratchet handle

| | | | |
|---------------|----------|----------|---------------|
| 802426 | l | g | pc/box |
| Part no. | mm | g | pc/box |
| 802426 | 130 | 397 | 1 |

NEW

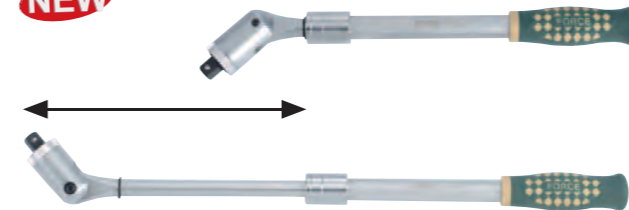

1/2" DR. Adjustable swivel ratchet handle

| | | | | |
|---------------|-------------|---------------|----------|---------------|
| 802434 | l | l | g | pc/box |
| Part no. | Normal (mm) | Extended (mm) | g | pc/box |
| 802434 | 435 | 680 | 1330 | 1 |



1/2" DR. Sliding T handle

| | | | |
|--------------------|----------|----------|---------------|
| 8034 | l | g | pc/box |
| Part no. | mm | g | pc/box |
| 8034125 NEW | 125-5" | 147 | 10 |
| 8034250 | 250-10" | 379 | 10 |
| 8034300 | 300-12" | 445 | 10 |

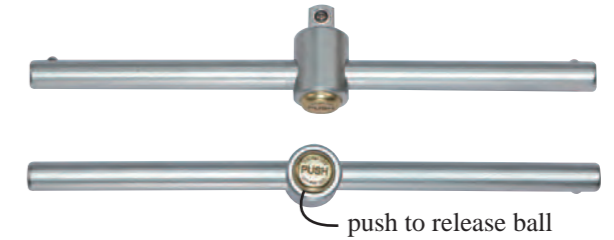

1/2" DR. Locking sliding T handle

| | | | |
|-----------------|----------|----------|---------------|
| 8034250L | l | g | pc/box |
| Part no. | mm | g | pc/box |
| 8034250L | 250-10" | 357 | 10 |



1/2" DR. Adjustable handle (turn-lock design)

| | | | |
|----------------|----------|----------|---------------|
| 8334300 | l | g | pc/box |
| Part no. | mm | g | pc/box |
| 8334300 | 310 | 496 | 2 |



1/2" DR. Ratchet handle (36 teeth)

| | | | |
|---------------|-------------------|----------|----------|
| 802433 | Packing | l | g |
| Part no. | Packing | mm | g |
| 802433 | 20/15.3/16.3/0.5" | 330 | 765 |

Combination:

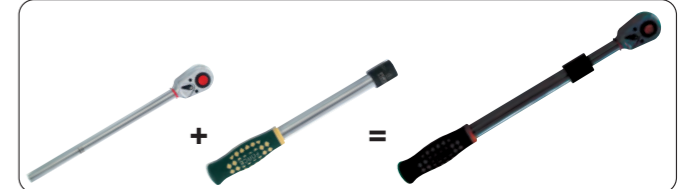

* Spare part available

**1/2" DR. Sliding T handle**

| 803A4300 | <i>l</i> | | |
|-----------------|----------|-----|--------|
| Part no. | mm | g | pc/box |
| 803A4300 | 300 | 570 | 5 |

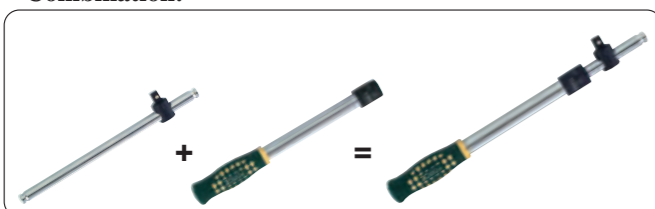
Combination:**1/2" DR. L handle**

| 815A4315 | <i>l</i> | | |
|-----------------|----------|-----|--------|
| Part no. | mm | g | pc/box |
| 815A4315 | 315 | 546 | 5 |

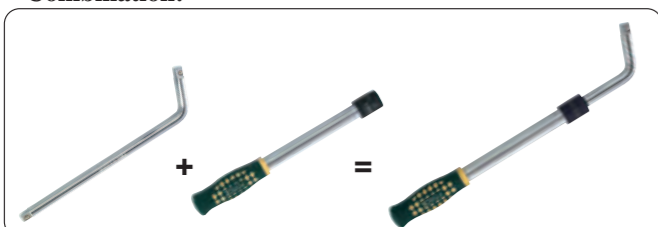
Combination:**1/2" DR. Extension**

| 8044 | <i>l</i> | | |
|----------------------------|----------|------|--------|
| Part no. | mm | g | pc/box |
| 8044050 | 50-2" | 101 | 200 |
| 8044075 | 75-3" | 141 | 150 |
| 8044100 <small>NEW</small> | 100-4" | 181 | 100 |
| 8044125 | 125-5" | 225 | 100 |
| 8044150 <small>NEW</small> | 150-6" | 257 | 100 |
| 8044250 | 250-10" | 438 | 50 |
| 8044380 | 380-15" | 425 | 40 |
| 8044450 <small>NEW</small> | 450-18" | 766 | 30 |
| 8044500 | 500-20" | 806 | 30 |
| 8044600 <small>NEW</small> | 600-24" | 1008 | 15 |
| 8044750 <small>NEW</small> | 750-30" | 1260 | 20 |
| 8044900 <small>NEW</small> | 900-36" | 1508 | 15 |

**1/2" DR. Extension-Thin**

| 8044..R | <i>l</i> | | |
|----------------|----------|-----|--------|
| Part no. | mm | g | pc/box |
| 8044075R | 75-3" | 128 | 10 |
| 8044125R | 125-5" | 192 | 10 |
| 8044250R | 250-10" | 342 | 5 |

**1/2" DR. Wobble extension**

| 8044..W | <i>l</i> | | |
|-----------------------------|----------|-----|--------|
| Part no. | mm | g | pc/box |
| 8044050W | 50-2" | 92 | 10 |
| 8044075W <small>NEW</small> | 75-3" | 122 | 10 |
| 8044125W | 125-5" | 185 | 10 |
| 8044175W <small>NEW</small> | 175-7" | 241 | 10 |
| 8044200W | 200-8" | 280 | 10 |
| 8044250W | 250-10" | 346 | 5 |

NEW**1/2" DR. Extension with light**

| 8044080L | | <i>l</i> | |
|-----------------|-------------------|----------|-----|
| Part no. | Packing | mm | g |
| 8044080L | 60/12.6/13.6/1.1" | 80 | 360 |

**1/2" DR. Universal & Extension**

| 80454300 | <i>l</i> | | |
|-----------------|-----------|-----|--------|
| Part no. | mm | g | pc/box |
| 80454300 | 300mm-12" | 647 | 5 |

**1/2" DR. Universal & Extension**

| 80454430 | <i>l</i> | | |
|-----------------|-----------|------|--------|
| Part no. | mm | g | pc/box |
| 80454430 | 430mm-17" | 1042 | 5 |

**1/2" DR. Universal joint**

| 80541 | <i>l</i> | | |
|--------------|----------|-----|--------|
| Part no. | mm | g | pc/box |
| 80541 | 70 | 149 | 10 |

**1/2" DR. Universal socket**

| 80545 | | <i>l</i> | | |
|----------------------------|--------|----------|-----|--------|
| Part no. | Socket | mm | g | pc/box |
| 8054513 | 13 | 63 | 131 | 10 |
| 8054514 | 14 | 63 | 136 | 10 |
| 8054515 | 15 | 63 | 136 | 10 |
| 8054516 <small>NEW</small> | 16 | 63 | 137 | 10 |
| 8054517 | 17 | 63 | 137 | 10 |
| 8054518 <small>NEW</small> | 18 | 63 | 144 | 10 |
| 8054519 | 19 | 63 | 151 | 10 |
| 8054520 <small>NEW</small> | 20 | 63 | 151 | 10 |
| 8054521 | 21 | 63 | 151 | 10 |
| 8054522 | 22 | 63 | 155 | 10 |
| 8054524 | 24 | 63 | 168 | 10 |
| 805451.2 | 1/2" | 63 | 130 | 10 |
| 805459.16 | 9/16" | 63 | 135 | 10 |
| 805455.8 | 5/8" | 63 | 136 | 10 |
| 8054511.16 | 11/16" | 63 | 137 | 10 |
| 805453.4 | 3/4" | 63 | 151 | 10 |
| 8054513.16 | 13/16" | 63 | 151 | 10 |
| 805457.8 | 7/8" | 63 | 153 | 10 |
| 8054515.16 | 15/16" | 63 | 167 | 10 |

**1/2" DR. Universal deep socket**

| 80545108 | | <i>l</i> | | |
|-----------------|--------|----------|-----|--------|
| Part no. | Socket | mm | g | pc/box |
| 8054510813 | 13 | 108 | 172 | 10 |
| 8054510814 | 14 | 108 | 179 | 10 |
| 8054510815 | 15 | 108 | 186 | 10 |
| 8054510817 | 17 | 108 | 201 | 10 |
| 8054510819 | 19 | 108 | 222 | 10 |
| 8054510821 | 21 | 108 | 255 | 10 |
| 8054510822 | 22 | 108 | 266 | 10 |
| 8054510824 | 24 | 108 | 283 | 10 |
| 805451081.2 | 1/2" | 108 | 173 | 10 |
| 805451089.16 | 9/16" | 108 | 175 | 10 |
| 805451085.8 | 5/8" | 108 | 179 | 10 |
| 8054510811.16 | 11/16" | 108 | 192 | 10 |
| 805451083.4 | 3/4" | 108 | 216 | 10 |
| 8054510813.16 | 13/16" | 108 | 259 | 10 |
| 805451087.8 | 7/8" | 108 | 266 | 10 |
| 8054510815.16 | 15/16" | 108 | 283 | 10 |

**1/2" DR. Star universal socket**

| 80546 | | <i>l</i> | | |
|--------------|--------|----------|-----|--------|
| Part no. | Socket | mm | g | pc/box |
| 8054608 | E8 | 65 | 124 | 10 |
| 8054610 | E10 | 65 | 124 | 10 |
| 8054611 | E11 | 65 | 125 | 10 |
| 8054612 | E12 | 65 | 127 | 10 |
| 8054614 | E14 | 65 | 127 | 10 |
| 8054616 | E16 | 65 | 133 | 10 |
| 8054618 | E18 | 65 | 133 | 10 |
| 8054620 | E20 | 65 | 177 | 10 |
| 8054624 | E24 | 65 | 177 | 10 |

**Adaptor for 1/2" DR. Extension**

| 80634 | | <i>l</i> | | |
|--------------|-------------------|----------|----|--------|
| Part no. | Size | mm | g | pc/box |
| 80634 | 3/8"(F) x 1/2"(M) | 46 | 70 | 10 |

**1/2" DR. Spark plug socket**

| 8074 | | <i>l</i> | | |
|-------------|---------|----------|-----|--------|
| Part no. | size | mm | g | pc/box |
| 807416 | 16 mm | 65 | 92 | 10 |
| 807418 | 18 mm | 65 | 133 | 10 |
| 807420.6 | 20.6 mm | 65 | 156 | 10 |

**1/2" DR. Magnetic spark plug socket**

| 8074..M | | <i>l</i> | | |
|----------------------------|---------|----------|-----|--------|
| Part no. | size | mm | g | pc/box |
| 807414M <small>NEW</small> | 14 mm | 70 | 67 | 10 |
| 807416M | 16 mm | 70 | 83 | 10 |
| 807418M | 18 mm | 70 | 135 | 10 |
| 807420.6M | 20.6 mm | 70 | 153 | 10 |

**1/2" DR. Locking extension**

| 8084 | <i>l</i> | | |
|-------------|----------|-----|--------|
| Part no. | mm | g | pc/box |
| 808405 | 125-5" | 227 | 100 |
| 808410 | 250-10" | 408 | 50 |
| 808415 | 375-15" | 504 | 30 |
| 808420 | 500-20" | 806 | 20 |

**1/2" DR. Adaptor**

| 8094 | | <i>l</i> | | |
|--------------------------|-------------------|----------|-----|--------|
| Part no. | size | mm | g | pc/box |
| 80942 <small>NEW</small> | 1/2"(F) x 1/4"(M) | 36 | 64 | 10 |
| 80943 | 1/2"(F) x 3/8"(M) | 36 | 65 | 10 |
| 80946 | 1/2"(F) x 3/4"(M) | 50 | 163 | 10 |

NEW**Adapter extension**

| 80943066 | | <i>l</i> | | |
|-----------------|-------------------|----------|----|--------|
| Part no. | size | mm | g | pc/box |
| 80943066 | 1/2"(F) - 3/8"(M) | 65.5 | 91 | 10 |

**1/2" Bit adaptor**

| 8095430 | | <i>l</i> | | |
|----------------|-------------------|----------|----|--------|
| Part no. | size | mm | g | pc/box |
| 8095430 | 5/16"Hex-1/2" Sq. | 30 | 30 | 10 |

**1/2" DR. Bit holder**

| 8104 | | <i>l</i> | | |
|-------------|--------------------|----------|----|--------|
| Part no. | size | mm | g | pc/box |
| 81042 | 1/2"(F) x 1/4"(F) | 38 | 53 | 10 |
| 81045 | 1/2"(F) x 5/16"(F) | 38 | 57 | 10 |
| 81047 | 1/2"(F) x 10mm(F) | 38 | 57 | 10 |
| 810414 | 1/2"(F) x 14mm(F) | 38 | 90 | 10 |

**1/2" L handle**

| 8154 | | <i>l</i> | | |
|----------------------------|---------|----------|-----|--------|
| Part no. | size | mm | g | pc/box |
| 8154190 <small>NEW</small> | 1/2"DR. | 260 | 241 | 5 |
| 8154260 | 1/2"DR. | 260 | 470 | 5 |

NEW**1/2" Speed handle**

| 8154410A | | <i>l</i> | | |
|-----------------|------|----------|-----|--------|
| Part no. | size | mm | g | pc/box |
| 8154410A | 1/2" | 415 | 638 | 20 |

**1/2" DR. Socket rail**

| 8194.. | | <i>l</i> | |
|---------------|-----|----------|-----|
| Part no. | PCS | mm | g |
| 819405 | 5 | 160 | 27 |
| 819409 | 9 | 260 | 44 |
| 819420 | 20 | 560 | 144 |

**1/2" DR. Speed T handle**

| 8194T | <i>l</i> | | |
|--------------|----------|-----|--------|
| Part no. | mm | g | pc/box |
| 8194T | 300 | 686 | 10 |

**1/2" DR. Plastic hanger**

| 8164 | | <i>l</i> | |
|-------------|---------|----------|---|
| Part no. | size | mm | g |
| 8164 | 1/2"DR. | 75 | 6 |

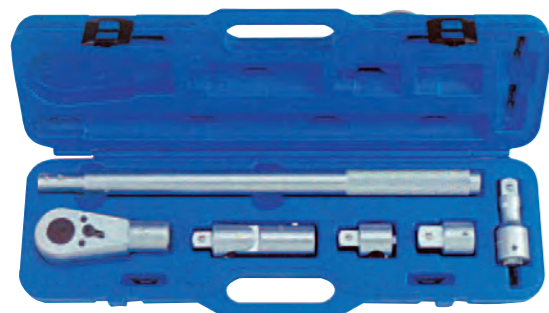

6pc 3/4" Accessory set

| | | |
|-------------|---|-------|
| 6061 | | |
| Part no. | 2/14.4/15.4/0.86' | 7.2kg |
| 8016800B | Content: 3/4"DR. 1-800mm Telescope adjustable handle | |
| 8026150 | 1-150mm 40 teeth ratchet head | |
| 8016135 | 1-135mm Universal flex head | |
| 8046100 | 1-100mm Extension bar | |
| 80361 | 1-Adaptor for sliding T handle | |
| 80968-6061 | 1-Adaptor 3/4"(F)x1"(M) | |

NEW



7pc 3/4" Socket bit set

| | | |
|-----------------|--|--------|
| K6072 | | |
| Part no. | 12/31.7/32.7/1.4' | 2.64kg |
| 366080 60...100 | Content: 3/4"DR. 5- Star socket bit (80mmL) T60, T70, T80, T90, T100 | |
| 368080 16T, 18T | 2- Spline socket bit (80mmL) M16, M18 | |



14pc 3/4" Socket set (MM)

| | | | |
|----------------|--|-------------------|------|
| 6141 | | | |
| Part no. | Socket | 1/11.0/12.0/0.46' | 11kg |
| 569 22...50 | Content: 3/4"DR. 10- 12pt. Flank socket 22; 24; 27; 30; 32; 36; 38; 41; 46; 50 mm | | |
| 8026500 | 1- Ratchet handle 500mmL | | |
| 8036450 | 1- Sliding T handle 450mmL | | |
| 8046 100...200 | 2- Extension bar 100; 200mmL | | |

| | | | |
|---------------|---|-------------------|------|
| 6141-5 | | | |
| Part no. | Socket | 1/11.0/12.0/0.46' | 11kg |
| 565 22...50 | Content: 3/4"DR. 10- 6pt. Flank socket 22; 24; 27; 30; 32; 36; 38; 41; 46; 50 mm | | |

14pc 3/4" Socket set (SAE)

| | | | |
|---------------|--|-------------------|------|
| 6141S | | | |
| Part no. | Socket | 1/11.0/12.0/0.46' | 11kg |
| 569 7.8...2.0 | Content: 3/4"DR. 10- 12pt. Flank socket 7/8"; 15/16"; 1"; 1-1/8"; 1-1/4"; 1-7/16"; 1-1/2"; 1-5/8"; 1-3/4"; 2" | | |



14pc 3/4" Socket set (MM)

| | | | |
|----------------|--|------------------|---------|
| 6141B | | | |
| Part no. | Socket | 2/20.7/21.7/1.5' | 10.35kg |
| 569 22...50 | Content: 3/4"DR. 10- 12pt. Flank socket 22; 24; 27; 30; 32; 36; 38; 41; 46; 50 mm | | |
| 8026500 | 1- Ratchet handle 500mmL | | |
| 8036450 | 1- Sliding T handle 450mmL | | |
| 8046 100...200 | 2- Extension bar 100; 200mmL | | |

| | | | |
|----------------|---|------------------|---------|
| 6141B-5 | | | |
| Part no. | Socket | 2/20.7/21.7/1.5' | 10.35kg |
| 565 22...50 | Content: 3/4"DR. 10- 6pt. Flank socket 22; 24; 27; 30; 32; 36; 38; 41; 46; 50 mm | | |

14pc 3/4" Socket set (SAE)

| | | | |
|---------------|--|------------------|---------|
| 6141SB | | | |
| Part no. | Socket | 2/20.7/21.7/1.5' | 10.35kg |
| 569 7.8...2.0 | Content: 3/4"DR. 10- 12pt. Flank socket 7/8"; 15/16"; 1"; 1-1/8"; 1-1/4"; 1-7/16"; 1-1/2"; 1-5/8"; 1-3/4"; 2" | | |



20pc 3/4" Socket set (MM)

| | | | |
|----------------|--|------------------|--------|
| 6201 | | | |
| Part no. | Socket | 1/12.5/13.5/0.5' | 12.5kg |
| 569 19...50 | Content: 3/4"DR. 16- 12pt. Flank socket 19; 21; 22; 23; 24; 26; 27; 29; 30; 32; 35; 36; 38; 41; 46; 50 mm | | |
| 8026500 | 1- Ratchet handle 500mmL | | |
| 8036450 | 1- Sliding T handle 450mmL | | |
| 8046 100...200 | 2- Extension bar 100; 200mmL | | |

| | | | |
|---------------|---|------------------|--------|
| 6201-5 | | | |
| Part no. | Socket | 1/12.5/13.5/0.5' | 12.5kg |
| 565 19...50 | Content: 3/4"DR. 16- 6pt. Flank socket 19; 21; 22; 23; 24; 26; 27; 29; 30; 32; 35; 36; 38; 41; 46; 50 mm | | |

20pc 3/4" Socket set (SAE)

| | | | |
|---------------|--|------------------|--------|
| 6201S | | | |
| Part no. | Socket | 1/12.5/13.5/0.5' | 12.5kg |
| 569 7.8...2.0 | Content: 3/4"DR. 16- 12pt. Flank socket 7/8"; 15/16"; 1"; 1-1/16; 1-1/8"; 1-3/16"; 1-1/4"; 1-5/16"; 1-3/8"; 1-7/16"; 1-1/2"; 1-5/8"; 1-3/4"; 1-13/16"; 1-7/8"; 2" | | |



20pc 3/4" Socket set (MM)

| | | | |
|----------------|--|------------------|---------|
| 6201B | | | |
| Part no. | Socket | 2/24.3/25.3/1.5' | 12.15kg |
| 569 19...50 | Content: 3/4"DR. 16- 12pt. Flank socket 19; 21; 22; 23; 24; 26; 27; 29; 30; 32; 35; 36; 38; 41; 46; 50 mm | | |
| 8026500 | 1- Ratchet handle 500mmL | | |
| 8036450 | 1- Sliding T handle 450mmL | | |
| 8046 100...200 | 2- Extension bar 100; 200mmL | | |

| | | | |
|------------------------------|---|------------------|---------|
| 6201B-5 | | | |
| Part no. | Socket | 2/24.3/25.3/1.5' | 12.15kg |
| Changed Items 565 19...50 | Content: 3/4"DR. 16- 6pt. Flank socket 19; 21; 22; 23; 24; 26; 27; 29; 30; 32; 35; 36; 38; 41; 46; 50 mm | | |

20pc 3/4" Socket set (SAE)

| | | | |
|--------------------------------|--|------------------|---------|
| 6201SB | | | |
| Part no. | Socket | 2/24.3/25.3/1.5' | 12.15kg |
| Changed Items 569 7.8...2.0 | Content: 3/4"DR. 16- 12pt. Flank socket 7/8"; 15/16"; 1"; 1-1/16; 1-1/8"; 1-3/16"; 1-1/4"; 1-5/16"; 1-3/8"; 1-7/16"; 1-1/2"; 1-5/8"; 1-3/4"; 1-13/16"; 1-7/8"; 2" | | |



21pc 3/4" Socket set (MM)

| | | | |
|----------------|--|------------------|------|
| 6212 | | | |
| Part no. | Socket | 2/26.0/27.0/1.5' | 13kg |
| 569 19...50 | Content: 3/4"DR. 16- 12pt. Flank socket 19; 21; 22; 23; 24; 26; 27; 29; 30; 32; 35; 36; 38; 41; 46; 50 mm | | |
| 8026500 | 1- Ratchet handle 500mmL | | |
| 8036450 | 1- Sliding T handle 450mmL | | |
| 8046 100...400 | 3- Extension bar 100; 200; 400mmL | | |

| | | | |
|------------------------------|---|------------------|------|
| 6212-5 | | | |
| Part no. | Socket | 2/26.0/27.0/1.5' | 13kg |
| Changed Items 565 19...50 | Content: 3/4"DR. 16- 6pt. Flank socket 19; 21; 22; 23; 24; 26; 27; 29; 30; 32; 35; 36; 38; 41; 46; 50 mm | | |

21pc 3/4" Socket set (SAE)

| | | | |
|--------------------------------|---|------------------|------|
| 6212S | | | |
| Part no. | Socket | 2/26.0/27.0/1.5' | 13kg |
| Changed Items 569 7.8...2.0 | Content: 3/4"DR. 16- 12pt. Flank socket 7/8"; 15/16"; 1"; 1-1/16"; 1-1/8"; 1-3/16"; 1-1/4"; 1-5/16"; 1-3/8"; 1-7/16"; 1-1/2"; 1-5/8"; 1-3/4"; 1-13/16"; 1-7/8"; 2" | | |

NEW



24pc 3/4" 12pt Flank Socket set

| | | | |
|---------------|--|------------------|------|
| 6241 | | | |
| Part no. | Socket | 2/26.0/27.0/1.5' | 13kg |
| 569 19...60 | Content: 3/4"DR. 16-12pt. Flank socket 19; 21; 22; 23; 24; 27; 30; 32; 34; 36; 38; 41; 46; 50; 55; 60mm | | |
| 36408014...22 | 4- Hex socket bit (80mmL) 14; 17; 19; 22mm | | |
| 8026820 | 1-Ajustable ratchet handle (Max. 820mmL) | | |
| 8036500 | 1-Sliding T handle 20" | | |
| 8046100...200 | 2-Extension 4";8 | | |

NEW



24pc 3/4" 12pt Flank Socket set

| | | | |
|----------------|---|------------------|------|
| 6241-72 | | | |
| Part no. | Socket | 2/26.0/27.0/1.5' | 13kg |
| 569 19...60 | Content: 3/4"DR. 16- 12pt. Flank socket 19; 21; 22; 23; 24; 27; 30; 32; 34; 36; 38; 41; 46; 50; 55; 60mm | | |
| 36408014...22 | 4- Hex socket bit (80mmL) 14; 17; 19; 22mm | | |
| 8026505 | 1-72 teeth QR Ratchet handle 500mmL | | |
| 8036500 | 1-Sliding T handle 20" | | |
| 8046100...200 | 2-Extension 4";8 | | |



NEW



26pc 3/4"DR. Socket set

| 6261 | Socket | 2/30.0/31.0/1.5' | 15Kg |
|----------------|---|------------------|------|
| Part no. | Content: 3/4" DR. | | |
| 569 22...50 | 10-12pt. Flank socket (Metric) 22; 24; 27; 30; 32; 36; 38; 41; 46; 50 mm | | |
| 569 7.8...2.0 | 12-12pt. Flank socket (SAE) 7/8"; 15/16"; 1"; 1-1/8"; 1-3/16"; 1-5/16"; 1-3/8"; 1-7/16"; 1-5/8"; 1-3/4" 1-7/8"; 2" | | |
| 8026500 | 1-Ratchet handle | | |
| 8036450 | 1-Sliding T handle 18" | | |
| 8046 100...200 | 2-Extension 4"; 8" | | |

NEW



3/4" Hex socket bit

| 364 | size | mm | g | pc/box |
|----------|------|----|-----|--------|
| Part no. | size | mm | g | pc/box |
| 36408014 | 14 | 80 | 319 | 3 |
| 36408016 | 16 | 80 | 338 | 3 |
| 36408017 | 17 | 80 | 348 | 3 |
| 36408019 | 19 | 80 | 358 | 3 |
| 36408022 | 22 | 80 | 396 | 3 |

NEW



3/4" Star socket bit

| 366 | size | mm | g | pc/box |
|-----------|------|----|-----|--------|
| Part no. | size | mm | g | pc/box |
| 36608060 | T60 | 80 | 310 | 3 |
| 36608070 | T70 | 80 | 314 | 3 |
| 36608080 | T80 | 80 | 340 | 3 |
| 36608090 | T90 | 80 | 343 | 3 |
| 366080100 | T100 | 80 | 370 | 3 |

NEW



3/4" Spline socket bit

| 368 | size | mm | g | pc/box |
|-----------|------|----|-----|--------|
| Part no. | size | mm | g | pc/box |
| 36808016T | M16T | 80 | 320 | 3 |
| 36808018T | M18T | 80 | 322 | 3 |



3/4"DR. 6pt. Flank socket

| 565 | size | mm | g | pc/box |
|----------|------|----|-----|--------|
| Part no. | size | mm | g | pc/box |
| 56519 | 19 | 50 | 180 | 2 |
| 56520 | 20 | 50 | 180 | 2 |
| 56521 | 21 | 50 | 224 | 2 |
| 56522 | 22 | 50 | 226 | 2 |
| 56523 | 23 | 50 | 230 | 2 |
| 56524 | 24 | 51 | 235 | 2 |
| 56525 | 25 | 52 | 243 | 2 |
| 56526 | 26 | 52 | 248 | 2 |
| 56527 | 27 | 52 | 254 | 2 |
| 56528 | 28 | 52 | 258 | 2 |
| 56529 | 29 | 52 | 261 | 2 |
| 56530 | 30 | 54 | 283 | 2 |
| 56531 | 31 | 56 | 309 | 2 |
| 56532 | 32 | 56 | 313 | 2 |
| 56533 | 33 | 56 | 344 | 2 |

565

| Part no. | size | mm | g | pc/box |
|----------|------|----|------|--------|
| 56534 | 34 | 56 | 321 | 2 |
| 56535 | 35 | 58 | 402 | 2 |
| 56536 | 36 | 58 | 439 | 2 |
| 56538 | 38 | 60 | 499 | 2 |
| 56540 | 40 | 62 | 500 | 2 |
| 56541 | 41 | 64 | 594 | 2 |
| 56542 | 42 | 64 | 580 | 2 |
| 56545 | 45 | 67 | 696 | 2 |
| 56546 | 46 | 68 | 713 | 2 |
| 56548 | 48 | 70 | 737 | 2 |
| 56550 | 50 | 72 | 878 | 2 |
| 56552 | 52 | 74 | 876 | 2 |
| 56554 | 54 | 74 | 900 | 2 |
| 56555 | 55 | 76 | 967 | 2 |
| 56558 | 58 | 78 | 1013 | 2 |
| 56560 | 60 | 78 | 994 | 2 |
| 56565 | 65 | 82 | 1115 | 2 |

3/4"DR. 12pt. Flank socket

| 569 | size | mm | g | pc/box |
|----------|------|----|-----|--------|
| Part no. | size | mm | g | pc/box |
| 56919 | 19 | 50 | 176 | 2 |
| 56920 | 20 | 50 | 177 | 2 |
| 56921 | 21 | 50 | 179 | 2 |
| 56922 | 22 | 50 | 222 | 2 |
| 56923 | 23 | 50 | 227 | 2 |
| 56924 | 24 | 51 | 230 | 2 |
| 56925 | 25 | 52 | 238 | 2 |
| 56926 | 26 | 52 | 249 | 2 |
| 56927 | 27 | 52 | 249 | 2 |
| 56928 | 28 | 52 | 259 | 2 |
| 56929 | 29 | 52 | 268 | 2 |
| 56930 | 30 | 54 | 280 | 2 |
| 56931 | 31 | 56 | 290 | 2 |
| 56932 | 32 | 56 | 294 | 2 |
| 56933 | 33 | 56 | 330 | 2 |
| 56934 | 34 | 56 | 350 | 2 |
| 56935 | 35 | 58 | 394 | 2 |
| 56936 | 36 | 58 | 420 | 2 |
| 56938 | 38 | 60 | 481 | 2 |
| 56941 | 41 | 64 | 540 | 2 |
| 56942 | 42 | 65 | 540 | 2 |
| 56946 | 46 | 68 | 677 | 2 |

569

| Part no. | size | mm | g | pc/box |
|------------|----------|----|------|--------|
| 56950 | 50 | 72 | 814 | 2 |
| 56952 | 52 | 74 | 813 | 2 |
| 56954 | 54 | 74 | 907 | 2 |
| 56955 | 55 | 76 | 949 | 2 |
| 56956 | 56 | 76 | 1000 | 2 |
| 56960 | 60 | 78 | 1013 | 2 |
| 56965 | 65 | 82 | 1100 | 2 |
| 5693.4 | 3/4" | 50 | 184 | 2 |
| 56913.16 | 13/16" | 50 | 202 | 2 |
| 5697.8 | 7/8" | 50 | 329 | 2 |
| 56915.16 | 15/16" | 51 | 386 | 2 |
| 5691.0 | 1" | 52 | 424 | 2 |
| 5691.1.16 | 1-1/16" | 52 | 476 | 2 |
| 5691.1.8 | 1-1/8" | 52 | 501 | 2 |
| 5691.3.16 | 1-3/16" | 54 | 559 | 2 |
| 5691.1.4 | 1-1/4" | 56 | 633 | 2 |
| 5691.5.16 | 1-5/16" | 56 | 650 | 2 |
| 5691.3.8 | 1-3/8" | 58 | 700 | 2 |
| 5691.7.16 | 1-7/16" | 58 | 730 | 2 |
| 5691.1.2 | 1-1/2" | 60 | 750 | 2 |
| 5691.9.16 | 1-9/16" | 62 | 800 | 2 |
| 5691.5.8 | 1-5/8" | 64 | 852 | 2 |
| 5691.11.16 | 1-11/16" | 65 | 894 | 2 |
| 5691.3.4 | 1-3/4" | 66 | 901 | 2 |
| 5691.13.16 | 1-13/16" | 68 | 924 | 2 |
| 5691.7.8 | 1-7/8" | 70 | 1049 | 2 |
| 5691.15.16 | 1-15/16" | 70 | 1086 | 2 |
| 5692.0 | 2" | 72 | 1127 | 2 |
| 5692.1.16 | 2-1/16" | 72 | 1162 | 2 |
| 5692.1.8 | 2-1/8" | 74 | 219 | 2 |
| 5692.3.16 | 2-3/16" | 76 | 232 | 2 |
| 5692.1.4 | 2-1/4" | 76 | 225 | 2 |
| 5692.5.16 | 2-5/16" | 78 | 231 | 2 |
| 5692.3.8 | 2-3/8" | 78 | 258 | 2 |
| 5692.7.16 | 2-7/16" | 80 | 280 | 2 |
| 5692.1.2 | 2-1/2" | 82 | 304 | 2 |





3/4"DR. Swivel handle

| Part no. | <i>l</i> mm | g | pc/box |
|----------------|----------------|-------|------------|
| 8016475 | 475-19" | 1900 | 10 |

* Spare part available

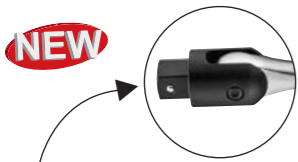

3/4"DR. Heavy Duty Swivel handle

| Part no. | <i>l</i> mm | g | pc/box |
|-----------------|----------------|-------|------------|
| 80161000 | 1000-40" | 3670 | 5 |

* Spare part available



3/4"DR. Ratchet handle

| Part no. | <i>l</i> mm | g | pc/box |
|----------------|----------------|-------|------------|
| 8026500 | 500-20" | 1970 | 10 |

* Spare part available



NEW



3/4"DR. QR Ratchet handle 72teeth

| Part no. | <i>l</i> mm | g | pc/box |
|----------------|----------------|-------|------------|
| 8026505 | 500 | 2800 | 10 |

* Spare part available



NEW

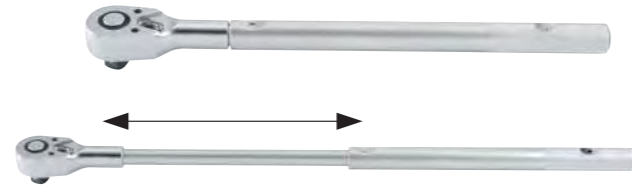

3/4"DR. Adjustable QR Ratchet handle 48teeth

| Part no. | <i>l</i> mm | <i>l</i> mm | g | pc/box |
|----------------|----------------|----------------|-------|------------|
| 8026820 | 520 | 820 | 3168 | 5 |

* Spare part available



3/4"DR. Sliding T handle

| Part no. | <i>l</i> mm | g | pc/box |
|-------------|----------------|-------|------------|
| 8036 | | | |
| 8036450 | 450-18" | 1388 | 10 |
| 8036500 | 500-20" | 1514 | 10 |

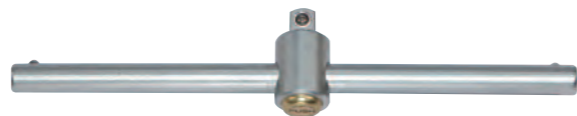

push to release ball

3/4"DR. Locking sliding T handle

| Part no. | <i>l</i> mm | g | pc/box |
|-----------------|----------------|-------|------------|
| 8036450L | 450-18" | 1350 | 10 |



3/4"DR. Extension

| Part no. | <i>l</i> mm | g | pc/box |
|-------------|----------------|-------|------------|
| 8046 | | | |
| 8046100 | 100-4" | 417 | 40 |
| 8046125 | 125-5" | 505 | 40 |
| 8046200 | 200-8" | 740 | 30 |
| 8046400 | 400-16" | 1358 | 15 |



3/4"DR. Universal joint

| Part no. | <i>l</i> mm | g | pc/box |
|--------------|----------------|-------|------------|
| 80561 | 109 | 625 | 2 |



3/4"DR. Locking extension

| Part no. | <i>l</i> mm | g | pc/box |
|-------------|----------------|-------|------------|
| 8086 | | | |
| 8086100 | 100-4" | 460 | 40 |
| 8086200 | 200-8" | 809 | 30 |
| 8086400 | 400-16" | 1598 | 15 |



3/4"DR. Adaptor

| Part no. | size | <i>l</i> mm | g | pc/box |
|-------------|-----------------|----------------|-------|------------|
| 8096 | | | | |
| 80964 | 3/4"(F)x1/2"(M) | 58 | 308 | 5 |
| 80968 | 3/4"(F)x1"(M) | 68 | 407 | 2 |



3/4"DR. L handle

| Part no. | <i>l</i> mm | g | pc/box |
|-------------|----------------|-------|------------|
| 8156 | | | |
| 8156330 | 330 | 1520 | 10 |
| 8156450 | 450 | 1990 | 10 |



3/4" DR. Plastic hanger

| Part no. | size | <i>l</i> mm | g |
|-------------|---------|----------------|-------|
| 8166 | 3/4"DR. | 95 | 11 |



14pc 1" Socket set (MM)

| Part no. | Socket | 1/26.8/27.8/0.83' | 26.8kg |
|----------------|--|---|--------|
| 589 36...80 | 10- 12pt. Flank socket | 36; 41; 46; 50; 55; 60; 65; 70; 75; 80 mm | |
| 80281 | 1- Ratchet head (head part of 8028650) | | |
| 80381 | 1- Adaptor for sliding T handle (adaptor of 8038550) | | |
| 8008550 | 1- 550mmL handle bar | | |
| 8048 200...400 | 2-Extension bar 200; 400mmL | | |



21pc 1" Socket set (MM)

| Part no. | Socket | 1/35.5/36.5/1.1' | 35.5kg |
|----------------|--|---|--------|
| 589 36...80 | 17- 12pt. Flank socket | 36; 38; 41; 46; 50; 54; 55; 58; 60; 63; 65; 67; 70; 71; 75; 77; 80 mm | |
| 80281 | 1- Ratchet head (head part of 8028650) | | |
| 80381 | 1- Adaptor for sliding T handle (adaptor of 8038550) | | |
| 8008550 | 1- 550mmL handle bar | | |
| 8048 200...400 | 2- Extension bar 200; 400mmL | | |

14pc 1" Socket set (SAE)

| Part no. | Socket | 1/26.8/27.8/0.83' | 26.8kg |
|----------------|------------------------|---|--------|
| 589 | 10- 12pt. Flank socket | 1-7/16"; 1-1/2"; 1-11/16"; 1-7/8"; 2"; 2-1/4"; 2-3/8"; 2-5/8"; 2-15/16"; 3-1/8" | |
| 1.7.16...3.1.8 | | | |

21pc 1" Socket set (SAE)

| Part no. | Socket | 1/35.5/36.5/1.1' | 35.5kg |
|----------------|------------------------|--|--------|
| 589 | 17- 12pt. Flank socket | 1-7/16"; 1-1/2"; 1-5/8"; 1-11/16"; 1-3/4"; 1-13/16"; 1-7/8"; 2"; 2-1/8"; 2-3/16"; 2-1/4"; 2-3/8"; 2-1/2"; 2-5/8"; 2-3/4"; 2-15/16"; 3-1/8" | |
| 1.7.16...3.1.8 | | | |



1"DR. Swivel handle

| Part no. | mm | g | pc/box |
|----------------|----------|----------|---------------|
| 8018650 | l | g | pc/box |
| 8018650 | 650-26" | 4122 | 5 |

* Spare part available



1"DR. Sliding T handle

| Part no. | mm | g | pc/box |
|----------------|----------|----------|---------------|
| 8038550 | l | g | pc/box |
| 8038550 | 550-22" | 3288 | 5 |

NEW



1"DR. Swivel Handle

| Part no. | mm | g | pc/box |
|-----------------|----------|----------|---------------|
| 80181000 | l | g | pc/box |
| 80181000 | 1000-39" | 3785 | 5 |

* Spare part available



1"DR. Extension

| Part no. | mm | g | pc/box |
|--------------------|----------|----------|---------------|
| 8048 | l | g | pc/box |
| 8048150 NEW | 150-6" | 1047 | 12 |
| 8048200 | 200-8" | 1330 | 12 |
| 8048400 | 400-16" | 2290 | 10 |



1"DR. Ratchet handle

| Part no. | mm | g | pc/box |
|----------------|----------|----------|---------------|
| 8028650 | l | g | pc/box |
| 8028650 | 650-26" | 4424 | 5 |

* Spare part available



1"DR. Universal joint

| Part no. | mm | g | pc/box |
|--------------|----------|----------|---------------|
| 80581 | l | g | pc/box |
| 80581 | 143 | 1237 | 2 |



1"DR. Adaptor

| 80986 | | | | |
|--------------|---------------|----------------|-------|------------|
| Part no. | size | <i>l</i> mm | g | pc/box |
| 80986 | 1"(F)x3/4"(M) | 74 | 964 | 2 |



1" DR. Plastic hanger

| 8168 | | | |
|-------------|------|----------------|-------|
| Part no. | size | <i>l</i> mm | g |
| 8168 | 1"DR | 115 | 18 |



1"DR. 12pt. Flank socket

| 589 | | | | |
|------------|----------|----------------|-------|------------|
| Part no. | size | <i>l</i> mm | g | pc/box |
| 58935 | 35 | 61 | 412 | 2 |
| 58936 | 36 | 65 | 468 | 2 |
| 58938 | 38 | 65 | 495 | 2 |
| 58941 | 41 | 70 | 601 | 2 |
| 58946 | 46 | 75 | 862 | 2 |
| 58950 | 50 | 75 | 1025 | 2 |
| 58954 | 54 | 80 | 1100 | 2 |
| 58955 | 55 | 80 | 1204 | 2 |
| 58958 | 58 | 80 | 1299 | 2 |
| 58960 | 60 | 84 | 1401 | 2 |
| 58963 | 63 | 87 | 1616 | 2 |
| 58965 | 65 | 87 | 1632 | 2 |
| 58967 | 67 | 90 | 1654 | 1 |
| 58970 | 70 | 93 | 2048 | 1 |
| 58971 | 71 | 93 | 2100 | 1 |
| 58975 | 75 | 97 | 2278 | 1 |
| 58977 | 77 | 103 | 2302 | 1 |
| 58980 | 80 | 103 | 2390 | 1 |
| 58985 | 85 | 106 | 2578 | 1 |
| 58990 | 90 | 110 | 3960 | 1 |
| 58995 | 95 | 110 | 4220 | 1 |

| 589 | | | | |
|------------|----------|----------------|-------|------------|
| Part no. | size | <i>l</i> mm | g | pc/box |
| 5891.3.8 | 1-3/8" | 61 | 412 | 2 |
| 5891.7.16 | 1-7/16" | 65 | 468 | 2 |
| 5891.1.2 | 1-1/2" | 65 | 495 | 2 |
| 5891.5.8 | 1-5/8" | 70 | 601 | 2 |
| 5891.11.16 | 1-11/16" | 70 | 710 | 2 |
| 5891.3.4 | 1-3/4" | 75 | 780 | 2 |
| 5891.13.16 | 1-13/16" | 75 | 862 | 2 |
| 5891.7.8 | 1-7/8" | 75 | 1000 | 2 |
| 5892.0 | 2" | 75 | 1045 | 2 |
| 5892.1.16 | 2-1/16" | 80 | 1100 | 2 |
| 5892.1.8 | 2-1/8" | 80 | 1150 | 2 |
| 5892.3.16 | 2-3/16" | 80 | 1204 | 2 |
| 5892.1.4 | 2-1/4" | 80 | 1238 | 2 |
| 5892.5.16 | 2-5/16" | 80 | 1340 | 2 |
| 5892.3.8 | 2-3/8" | 84 | 1368 | 2 |
| 5892.7.16 | 2-7/16" | 87 | 1530 | 2 |
| 5892.1.2 | 2-1/2" | 87 | 1550 | 2 |
| 5892.9.16 | 2-9/16" | 90 | 1690 | 1 |
| 5892.5.8 | 2-5/8" | 90 | 1800 | 1 |
| 5892.11.16 | 2-11/16" | 93 | 1950 | 1 |
| 5892.3.4 | 2-3/4" | 93 | 2250 | 1 |
| 5892.13.16 | 2-13/16" | 93 | 2350 | 1 |
| 5892.7.8 | 2-7/8" | 97 | 2210 | 1 |
| 5892.15.16 | 2-15/16" | 97 | 2330 | 1 |
| 5893.0 | 3" | 103 | 2390 | 1 |
| 5893.1.8 | 3-1/8" | 103 | 2578 | 1 |



1"DR. L handle

| 8158650 | | | |
|----------------|----------------|-------|------------|
| Part no. | <i>l</i> mm | g | pc/box |
| 8158650 | 650 | 4940 | 4 |



NEW

1"DR. 6pt. Flank socket

| 585 | | | | |
|------------|----------|----------------|-------|------------|
| Part no. | size | <i>l</i> mm | g | pc/box |
| 58560 | 60 | 84 | 1400 | 2 |
| 58565 | 65 | 87 | 1632 | 2 |
| 58570 | 70 | 93 | 2048 | 1 |
| 58575 | 75 | 97 | 2278 | 1 |
| 58580 | 80 | 103 | 2390 | 1 |



13pc 1/4"DR. 6pt. Flank impact socket set

| Part no. | Socket | 24/21.1/22.2/1.5' | 880g |
|-------------|---|-------------------|------|
| 425 04...13 | Content: 1/4"DR. 12- 6pt. Flank impact socket (MM) 4; 4.5; 5; 5.5; 6; 7; 8; 9; 10; 11; 12; 13 mm | | |
| 82421 | 1-Palm impact ratchet wrench | | |



13pc 1/4"DR. 6pt. Flank impact socket set

| Part no. | Socket | 24/23.2/24.2/1.5' | 965g |
|-------------|---|-------------------|------|
| 425 04...13 | Content: 1/4"DR. 12- 6pt. Flank impact socket (MM) 4; 4.5; 5; 5.5; 6; 7; 8; 9; 10; 11; 12; 13 mm | | |
| 82422 | 1-Stubby impact ratchet wrench | | |



23pc 1/4"DR. 6pt. Flank impact socket set (SAE&MM)

| Part no. | Socket | 24/24.7/25.7/1.5' | 1030g |
|----------------|--|-------------------|-------|
| 425 04...13 | Content: 1/4"DR. 12-6pt. Flank impact socket (MM) 4; 4.5; 5; 5.5; 6; 7; 8; 9; 10; 11; 12; 13 mm | | |
| 425 5.32...1.2 | 10-6pt. Flank impact socket (SAE) 5/32"; 3/16"; 7/32"; 1/4"; 9/32"; 5/16"; 11/32"; 3/8"; 7/16"; 1/2" | | |
| 82421 | 1-Palm impact ratchet wrench | | |



23pc 1/4"DR. 6pt. Flank impact socket set (SAE&MM)

| Part no. | Socket | 24/26.9/27.9/1.5' | 1120g |
|----------------|--|-------------------|-------|
| 425 04...13 | Content: 1/4"DR. 12-6pt. Flank impact socket (MM) 4; 4.5; 5; 5.5; 6; 7; 8; 9; 10; 11; 12; 13 mm | | |
| 425 5.32...1.2 | 10-6pt. Flank impact socket (SAE) 5/32"; 3/16"; 7/32"; 1/4"; 9/32"; 5/16"; 11/32"; 3/8"; 7/16"; 1/2" | | |
| 82422 | 1-Stubby impact ratchet wrench | | |



1/4" DR. 6pt. Flank impact socket

| Part no. | Socket | mm | g | pc/box |
|------------|--------|----|----|--------|
| 425 | | | | |
| 42504 | 4 | 23 | 10 | 50 |
| 425045 | 4.5 | 23 | 13 | 50 |
| 42505 | 5 | 23 | 13 | 50 |
| 425055 | 5.5 | 23 | 13 | 50 |
| 42506 | 6 | 23 | 13 | 50 |
| 42507 | 7 | 23 | 14 | 50 |
| 42508 | 8 | 23 | 14 | 50 |
| 42509 | 9 | 23 | 18 | 50 |
| 42510 | 10 | 23 | 24 | 50 |
| 42511 | 11 | 23 | 24 | 50 |
| 42512 | 12 | 23 | 27 | 50 |
| 42513 | 13 | 23 | 32 | 50 |
| 42514 | 14 | 23 | 36 | 50 |
| 4255.32 | 5/32" | 23 | 10 | 50 |
| 4253.16 | 3/16" | 23 | 13 | 50 |
| 4257.32 | 7/32" | 23 | 13 | 50 |
| 4251.4 | 1/4" | 23 | 13 | 50 |
| 4259.32 | 9/32" | 23 | 13 | 50 |
| 4255.16 | 5/16" | 23 | 14 | 50 |
| 42511.32 | 11/32" | 23 | 14 | 50 |
| 4253.8 | 3/8" | 23 | 18 | 50 |
| 4257.16 | 7/16" | 23 | 24 | 50 |
| 4251.2 | 1/2" | 23 | 32 | 50 |
| 4259.16 | 9/16" | 23 | 36 | 50 |



1/4" DR. Magnetic 6pt. Flank impact socket

| Part no. | Socket | mm | g | pc/box |
|---------------|--------|----|----|--------|
| 42507M | | | | |
| 42507M | 7 | 23 | 16 | 20 |



1/4" DR. Star impact socket

| Part no. | Socket | mm | g | pc/box |
|------------|--------|----|----|--------|
| 426 | | | | |
| 42604 | E4 | 23 | 12 | 50 |
| 42605 | E5 | 23 | 12 | 50 |
| 42606 | E6 | 23 | 12 | 50 |
| 42607 | E7 | 23 | 12 | 50 |
| 42608 | E8 | 23 | 14 | 50 |
| 42610 | E10 | 23 | 16 | 50 |



1/4" DR. Adaptor (ball type)

| Part no. | Size | mm | g | pc/box |
|-----------------|-----------------|----|------|--------|
| 80923MPB | | | | |
| 80923MPB | 1/4"(F)x3/8"(M) | 27 | 20.5 | 10 |



1/4" DR. Palm impact ratchet wrench

| Part no. | mm | g | pc/box |
|--------------|------------|-----|--------|
| 82421 | | | |
| 82421 | 125mm-4.9" | 450 | 1 |

Specifications :

- Square Drive..... 1/4"
- Free Speed (R.P.M.)..... 250
- Working Torque Range (Ft/Lbs) / (N-M)..... 0-20/0-27
- Max. Torque (Ft/Lbs)/(N-M)..... 25/33
- Air Pressure (PSI)..... 90
- AIR Inlet (P.T.)..... 1/4"
- Air Consumption (C.F.M.)..... 2.4
- Sound Pressure Level (dBA)..... 79.9



1/4" DR. Stubby impact ratchet wrench

| Part no. | mm | g | pc/box |
|--------------|------------|-----|--------|
| 82422 | | | |
| 82422 | 165mm-6.5" | 500 | 1 |

Specifications :

- Square Drive..... 1/4"
- Free Speed (R.P.M.)..... 240
- Working Torque Range (Ft/Lbs) / (N-M)..... 5-20/7-27
- Max. Torque (Ft/Lbs) / (N-M)..... 30/40.5
- Air Pressure (PSI)..... 90
- AIR Inlet (P.T.)..... 1/4"
- Air Consumption (C.F.M.)..... 2.5



5pc 3/8" Star impact socket set

| Part no. | Socket | 80/24.0/25.0/1.4' | 300g |
|-------------|--------|-------------------|------|
| 3063 | | | |
| 436 06...08 | | | |
| 446 10...14 | | | |

Content: 3/8" DR. & 1/2" DR. 5-Impact star socket
3/8": E6; E8;
1/2": E10; E12; E14



8pc 3/8" Impact socket set (MM)

| Part no. | Socket | 40/18.7/19.7/0.55' | 468g |
|-------------|--------|--------------------|------|
| 3083 | | | |
| 435 08...19 | | | |

Content: 3/8" DR. 8-Impact socket
8; 10; 11; 12; 13; 14; 17; 19 mm

| Part no. | Socket | 40/18.7/19.7/0.55' | 468g |
|----------------|--------|--------------------|------|
| 3083S | | | |
| 435 5.16...3.4 | | | |

Content: 3/8" DR. 8-Impact socket
5/16"; 3/8"; 7/16"; 1/2"; 9/16"; 5/8";
11/16"; 3/4"





8pc 3/8" Impact deep socket set (MM)

| | | | |
|---------------|--|-------------------|------|
| 3084 | | | |
| Part no. | Socket | 20/17.7/18.7/0.5' | 885g |
| 43563 08...19 | Content: 3/8"DR. 8-Impact deep socket 8; 10; 11; 12; 13; 14; 17; 19 mm | | |

8pc 3/8" Impact deep socket set (SAE)

| | | | |
|------------------|--|-------------------|------|
| 3084S | | | |
| Part no. | Socket | 20/17.7/18.7/0.5' | 885g |
| 43563 5.16...3.4 | Content: 3/8"DR. 8-Impact deep socket 5/16"; 3/8"; 7/16"; 1/2"; 9/16"; 5/8"; 11/16"; 3/4" | | |



13pc Impact wrench socket set

| | | | |
|--------------|--|-------------------|-------|
| K3133 | | | |
| Part no. | Socket | 24/24.7/25.7/1.5' | 1030g |
| 435 06...19 | Content: 3/8"DR. 11-6pt. Flank impact socket 6; 7; 8; 10; 11; 12; 13; 14; 15; 17; 19 mm | | |
| 82432 | 1-Palm impact ratchet wrench | | |
| 8043075MPB | 1-Impact extension (ball type) | | |



13pc Impact wrench socket set

| | | | |
|----------------|--|-------------------|-------|
| K3133-3 | | | |
| Part no. | Socket | 24/26.9/27.9/1.5' | 1120g |
| 435 06...19 | Content: 3/8"DR. 11-6pt. Flank impact socket 6; 7; 8; 10; 11; 12; 13; 14; 15; 17; 19 mm | | |
| 82433 | 1-Stubby impact ratchet wrench | | |
| 8043075MPB | 1-Impact extension (ball type) | | |

NEW



23pc 3/8"DR. Impact wrench & socket set

| | | | |
|---------------|--|-------------------|-------|
| 3233 | | | |
| Part no. | Socket | 6/19.8/20.8/1.54' | 3.3kg |
| 435 10...22 | Content: 3/8"DR. 10-6pt. Flank impact socket 10; 11; 12; 13; 14; 16; 17; 19; 21; 22 mm | | |
| 82531 | 1-Mini impact wrench | | |
| 80934MPP | 1-Adaptor 3/8"(F)x1/2"(M) (pin type) | | |
| 8043075MPB | 1-Impact extension 3" (ball type) | | |
| 80531MPB | 1-Universal joint (ball type) | | |
| 23452 06...12 | 5-Hex impact socket bit (one-piece) 6; 7; 8; 10; 12 mm | | |
| 23652 30...50 | 4-Star impact socket bit (one-piece) T30; T40; T45; T50 | | |



3/8" Hex impact socket bit(one-piece)

| | | | | |
|--------------|--------|----|----|--------|
| 23452 | | | | |
| Part no. | Socket | mm | g | pc/box |
| 2345204 | 4 | 52 | 35 | 10 |
| 2345205 | 5 | 52 | 38 | 10 |
| 2345206 | 6 | 52 | 41 | 10 |
| 2345207 | 7 | 52 | 43 | 10 |
| 2345208 | 8 | 52 | 47 | 10 |
| 2345210 | 10 | 52 | 57 | 10 |
| 2345212 | 12 | 52 | 66 | 10 |
| 234521.4 | 1/4" | 52 | 39 | 10 |
| 234523.8 | 3/8" | 52 | 50 | 10 |
| 234521.2 | 1/2" | 52 | 66 | 10 |



3/8" DR. 6pt. Flank impact socket

| | | | | |
|------------|--------|----|----|--------|
| 435 | | | | |
| Part no. | Socket | mm | g | pc/box |
| 43506 | 6 | 32 | 30 | 20 |
| 43507 | 7 | 32 | 31 | 20 |
| 43508 | 8 | 32 | 32 | 20 |
| 43509 | 9 | 32 | 33 | 20 |
| 43510 | 10 | 32 | 34 | 20 |
| 43511 | 11 | 32 | 36 | 20 |
| 43512 | 12 | 32 | 38 | 20 |
| 43513 | 13 | 32 | 40 | 20 |
| 43514 | 14 | 32 | 51 | 20 |
| 43515 | 15 | 32 | 54 | 20 |
| 43516 | 16 | 32 | 55 | 20 |
| 43517 | 17 | 32 | 55 | 20 |
| 43518 | 18 | 32 | 55 | 20 |
| 43519 | 19 | 32 | 59 | 20 |
| 43520 | 20 | 32 | 60 | 20 |
| 43521 | 21 | 32 | 61 | 20 |
| 43522 | 22 | 32 | 62 | 20 |
| 4353513 | 13 | 35 | 41 | 20 |
| 4357810 | 10 | 78 | 77 | 20 |
| 4355.16 | 5/16" | 32 | 30 | 20 |
| 4353.8 | 3/8" | 32 | 31 | 20 |
| 4357.16 | 7/16" | 32 | 36 | 20 |
| 4351.2 | 1/2" | 32 | 38 | 20 |
| 4359.16 | 9/16" | 32 | 51 | 20 |
| 4355.8 | 5/8" | 32 | 55 | 20 |
| 43511.16 | 11/16" | 32 | 55 | 20 |
| 4353.4 | 3/4" | 32 | 59 | 20 |
| 43513.16 | 13/16" | 32 | 61 | 20 |
| 4357.8 | 7/8" | 32 | 62 | 20 |



3/8" DR. Star impact socket bit(one-piece)

| | | | | |
|--------------|--------|----|----|--------|
| 23652 | | | | |
| Part no. | Socket | mm | g | pc/box |
| 2365220 | T20 | 52 | 25 | 10 |
| 2365225 | T25 | 52 | 35 | 10 |
| 2365227 | T27 | 52 | 38 | 10 |
| 2365230 | T30 | 52 | 38 | 10 |
| 2365240 | T40 | 52 | 40 | 10 |
| 2365245 | T45 | 52 | 45 | 10 |
| 2365250 | T50 | 52 | 50 | 10 |



3/8" DR. 6pt. Flank impact deep socket

| 43563 | | | | |
|--------------|--------|----|-----|--------|
| Part no. | Socket | mm | g | pc/box |
| 4356308 | 8 | 63 | 48 | 20 |
| 4356309 | 9 | 63 | 54 | 20 |
| 4356310 | 10 | 63 | 58 | 20 |
| 4356311 | 11 | 63 | 64 | 20 |
| 4356312 | 12 | 63 | 80 | 20 |
| 4356313 | 13 | 63 | 85 | 20 |
| 4356314 | 14 | 63 | 92 | 20 |
| 4356315 | 15 | 63 | 110 | 20 |
| 4356316 | 16 | 63 | 108 | 20 |
| 4356317 | 17 | 63 | 108 | 20 |
| 4356318 | 18 | 63 | 129 | 20 |
| 4356319 | 19 | 63 | 138 | 20 |
| 435635.16 | 5/16" | 63 | 48 | 20 |
| 435633.8 | 3/8" | 63 | 58 | 20 |
| 435637.16 | 7/16" | 63 | 64 | 20 |
| 435631.2 | 1/2" | 63 | 80 | 20 |
| 435639.16 | 9/16" | 63 | 92 | 20 |
| 435635.8 | 5/8" | 63 | 110 | 20 |
| 4356311.16 | 11/16" | 63 | 108 | 20 |
| 435633.4 | 3/4" | 63 | 138 | 20 |



3/8" DR. Magnetic 6pt. Flank impact socket

| 435...M | | | | |
|----------------|--------|----|----|--------|
| Part no. | Socket | mm | g | pc/box |
| 43508M | 8 | 32 | 36 | 20 |
| 43510M | 10 | 32 | 39 | 20 |
| 43512M | 12 | 32 | 44 | 20 |
| 43513M | 13 | 32 | 46 | 20 |



3/8" DR. Star impact socket

| 436 | | | | |
|------------|--------|----|----|--------|
| Part no. | Socket | mm | g | pc/box |
| 43604 | E4 | 28 | 31 | 20 |
| 43605 | E5 | 28 | 31 | 20 |
| 43606 | E6 | 28 | 31 | 20 |
| 43607 | E7 | 28 | 31 | 20 |
| 43608 | E8 | 28 | 32 | 20 |
| 43610 | E10 | 28 | 32 | 20 |
| 43611 | E11 | 28 | 32 | 20 |
| 43612 | E12 | 28 | 34 | 20 |
| 43614 | E14 | 28 | 37 | 20 |



3/8" DR. Impact extension (pin type)

| 8043..MPP | | | |
|------------------|--------|-----|--------|
| Part no. | mm | g | pc/box |
| 8043075MPP | 75-3" | 76 | 10 |
| 8043150MPP | 150-6" | 145 | 10 |

3/8" DR. Impact extension (ball type)

| 8043..MPB | | | |
|------------------|--------|-----|--------|
| Part no. | mm | g | pc/box |
| 8043075MPB | 75-3" | 78 | 10 |
| 8043125MPB | 125-5" | 123 | 10 |
| 8043150MPB | 150-6" | 147 | 10 |
| 8043200MPB | 200-8" | 190 | 10 |



3/8" DR. Impact extension socket

| 80435 | | | | |
|--------------|--------|-----|-----|--------|
| Part no. | Socket | mm | g | pc/box |
| 8043510010 | 10 | 100 | 100 | 10 |
| 8043510012 | 12 | 100 | 110 | 10 |
| 8043510014 | 14 | 100 | 116 | 10 |
| 8043510016 | 16 | 100 | 123 | 10 |
| 8043515010 | 10 | 150 | 134 | 10 |
| 8043515016 | 16 | 150 | 152 | 10 |



3/8" DR. magnetic impact extension socket

| 80435...M | | | | |
|------------------|--------|-----|-----|--------|
| Part no. | Socket | mm | g | pc/box |
| 8043510010M | 10 | 100 | 105 | 10 |
| 8043515010M | 10 | 150 | 135 | 10 |
| 8043515013M | 13 | 150 | 147 | 10 |



3/8" DR. Universal joint (pin type)

| 80531MPP | | | |
|-----------------|----|-----|--------|
| Part no. | mm | g | pc/box |
| 80531MPP | 71 | 110 | 10 |



3/8" DR. Universal joint (ball type)

| 80531MPB | | | |
|-----------------|----|----|--------|
| Part no. | mm | g | pc/box |
| 80531MPB | 71 | 88 | 10 |



3/8" DR. Adaptor (pin type)

| 8093..MPP | | | | |
|------------------|-------------------|----|----|--------|
| Part no. | Size | mm | g | pc/box |
| 80932MPP | 3/8"(F) x 1/4"(M) | 28 | 50 | 10 |
| 80934MPP | 3/8"(F) x 1/2"(M) | 36 | 46 | 10 |



3/8" DR. Adaptor (ball type)

| 8093..MPB | | | | |
|------------------|-------------------|----|----|--------|
| Part no. | Size | mm | g | pc/box |
| 80932MPB | 3/8"(F) x 1/4"(M) | 28 | 50 | 10 |
| 80934MPB | 3/8"(F) x 1/2"(M) | 36 | 46 | 10 |



3/8" DR. Bit holder

| 8103..MPB | | | | |
|------------------|-----------------------|----|----|--------|
| Part no. | Size | mm | g | pc/box |
| 81032MPB | 3/8"(F) x 1/4"hex(F) | 40 | 36 | 10 |
| 81035MPB | 3/8"(F) x 5/16"hex(F) | 40 | 49 | 10 |



O-ring & Pin for 3/8" DR.

| Part no. | mm | mm | g |
|----------|-----------|------------|---|
| R1335 | Ø13- Ø3.5 | - | 2 |
| P1425 | - | 14L- Ø 2.0 | 2 |
| R1635 | Ø16- Ø3.5 | - | 2 |
| P1625 | - | 16L- Ø 2.5 | 2 |



3/8"DR. Palm impact ratchet wrench

| 82432 | l | | |
|--------------|------------|-----|--------|
| Part no. | mm | g | pc/box |
| 82432 | 125mm-4.9" | 450 | 1 |

Specifications :

- Square Drive..... 3/8"
- Free Speed (R.P.M.)..... 250
- Working Torque Range (Ft/Lbs) / (N-M)..... 0-20/0-27
- Max. Torque (Ft/Lbs) / (N-M)..... 25 / 33
- Air Pressure (PSI)..... 90
- AIR Inlet (P.T.)..... 1/4"
- Air Consumption (C.F.M.)..... 2.4
- Sound Pressure Level (dBA)..... 79.9



3/8"DR. Stubby impact ratchet wrench

| 82433 | l | | |
|--------------|------------|-----|--------|
| Part no. | mm | g | pc/box |
| 82433 | 165mm-6.5" | 500 | 1 |

Specifications :

- Square Drive..... 3/8"
- Free Speed (R.P.M.)..... 240
- Working Torque Range (Ft/Lbs) / (N-M)..... 5-20 / 7-27
- Max. Torque (Ft/Lbs) / (N-M)..... 30 / 40.5
- Air Pressure (PSI)..... 90
- AIR Inlet (P.T.)..... 1/4"
- Air Consumption (C.F.M.)..... 2.5
- Sound Pressure Level (dBA)..... 87.7



3/8"DR. Mini impact wrench

| 82531 | l | | |
|--------------|------------|------|--------|
| Part no. | mm | g | pc/box |
| 82531 | 145mm-5.7" | 1500 | 1 |

Specifications :

- Square Drive..... 3/8"
- Free Speed (R.P.M.)..... 12500
- Working Torque Range (Ft/Lbs) / (N-M)..... 90-260 / 120-351
- Max. Torque (Ft/Lbs) / (N-M)..... 300 / 400
- Air Pressure (PSI)..... 90
- AIR Inlet (P.T.)..... 1/4"
- Air Consumption (C.F.M.)..... 4



3/8"DR. Mini composite impact wrench

| 82532 | l | | |
|--------------|----------|------|--------|
| Part no. | mm | g | pc/box |
| 82532 | 154mm-6" | 1200 | 1 |

Specifications :

- Square Drive..... 3/8"
- Free Speed (R.P.M.)..... 12500
- Working Torque Range (Ft/Lbs) / (N-M)..... 90-260 / 120-351
- Max. Torque (Ft/Lbs) / (N-M)..... 300 / 400
- Air Pressure (PSI)..... 90
- AIR Inlet (P.T.)..... 1/4"
- Air Consumption (C.F.M.)..... 4



3/8"DR. Air impact hammer drill

| 82731 | l | | |
|--------------|------------|------|--------|
| Part no. | mm | g | pc/box |
| 82731 | 185mm-7.3" | 1070 | 1 |

Specifications :

- Drill Capacity (mm)..... 10
- Free Speed (R.P.M.)..... 2500
- Air Pressure (PSI)..... 90
- AIR Inlet (P.T.)..... 1/4"
- Air Consumption (C.F.M.)..... 8
- Reversible..... Yes



3/8"DR. Air impact hammer drill

| 82733 | l | | |
|--------------|------------|-----|--------|
| Part no. | mm | g | pc/box |
| 82733 | 210mm-8.3" | 870 | 1 |

Specifications :

- Drill Capacity (mm)..... 9.5
- Free Speed (R.P.M.)..... 1600
- Air Pressure (PSI)..... 90
- AIR Inlet (P.T.)..... 1/4"
- Air Consumption (C.F.M.)..... 2
- Reversible..... Yes



3pc 1/2"DR. Wheel nut impact socket set

| K4032 | | | |
|--------------|--------|-------------------|------|
| Part no. | Socket | 24/22.3/23.3/1.5' | 930g |

Content: 1/2"DR. 3-Wheel nut 6pt. flank impact socket 17; 19; 21mm (85mmL)

| 4032 NEW | | | |
|-----------------|--------|-------------------|------|
| Part no. | Socket | 24/22.3/23.3/1.5' | 930g |

Changed package | package in blow mold case



3pc 1/2" DR. 6pt. Flank impact thin-wall deep socket set

| 4032TH | | | |
|---------------|--------|-------------------|------|
| Part no. | Socket | 24/19.2/20.2/1.1' | 800g |

Content: 1/2"DR. 3-6pt. Flank impact thin-wall deep socket 17, 19, 21 mm

NEW



4pc 1/2" DR. Wheel nut 6pt. flank impact socket set

| | | | |
|-----------------|--|--------------------|-------|
| 4046 | | | |
| Part no. | Socket | 12/15.2/16.2/0.75' | 1266g |
| 44585 17C...22C | Content: 1/2"DR. 4-Wheel nut 6pt. flank impact socket 17, 19, 21, 22mm | | |

| | | | |
|----------------------------------|--|--------------------|-------|
| 4046A | | | |
| Part no. | Socket | 12/13.7/14.7/0.75' | 1141g |
| Changed Items 44585 17C...21C | Content: 1/2"DR. 4-Wheel nut 6pt. flank impact socket 15, 17, 19, 21mm | | |

| | | | |
|----------------------------------|--|--------------------|-------|
| 4046B | | | |
| Part no. | Socket | 12/15.3/16.3/0.75' | 1271g |
| Changed Items 44585 17C...23C | Content: 1/2"DR. 4-Wheel nut 6pt. flank impact socket 15, 17, 19, 23mm | | |



7pc 1/2" Impact star set

| | | | |
|-------------|---|-------------------|-------|
| 4073 | | | |
| Part no. | Socket | 20/23.0/24.0/1.1' | 1150g |
| 446 06...18 | Content: 1/2"DR. 7-Impact star socket E6; E8; E10; E12; E14; E16; E18 | | |



3pc 1/2" DR. Wheel nut deep impact socket set

| | | | |
|------------------|--|-------------------|-------|
| K4033 | | | |
| Part no. | Socket | 24/33.6/34.6/1.5' | 1435g |
| 445150 17C...21C | Content: 1/2"DR. 3-Wheel nut 6pt. flank deep impact socket 17; 19; 21mm (150mmL) | | |

| | | | |
|-----------------|---------------------------|---------------|-------|
| 4033 NEW | | | |
| Part no. | Socket | 20/25/26/1.1' | 1435g |
| Change package | package in blow mold case | | |



7pc 1/2" Hex impact socket bit set

| | | | |
|----------------|--|--------------------|------|
| 4077 | | | |
| Part no. | Bit | 20/16.0/17.0/0.82' | 800g |
| 244060 04...14 | Content: 1/2"DR. 7-Hex impact socket bit (one-piece) 4; 5; 6; 8; 10; 12; 14 mm (60mmL) | | |



7pc 1/2" Star impact socket bit set

| | | | |
|----------------|---|--------------------|-------|
| 4078 | | | |
| Part no. | Bit | 20/22.0/23.5/0.82' | 1100g |
| 246060 30...70 | Content: 1/2"DR. 7- Star impact socket bit (one-piece) T30; T40; T45; T50; T55; T60; T70 (60mmL) | | |



7pc Impact adapter (ball type)

| | | |
|------------------|---|-------|
| K4079 | | |
| Part no. | 12/23.5/24.5/1.4' | 1958g |
| 80932MPB...86MPB | Content: 1/2"DR. 7- Impact Adapter (ball type) 3/8"(F)x1/4"(M); 3/8"(F)x1/2"(M); 1/2"(F)x3/8"(M); 1/2"(F)x3/4"(M); 3/4"(F)x1/2"(M); 3/4"(F)x1"(M); 1"(F)x3/4"(M) | |

NEW



7pc Wheel nut impact socket set

| | | |
|-----------------|--|-------|
| 40710 | | |
| Part no. | 10/27.6/28.6/1.3' | 2700g |
| 44585 17C...23C | Content: 1/2"DR. 4-Wheel nut impact socket 17; 19; 21; 23 mm | |
| 8334300 | 1-Adjustable handle (turn-lock design) 310mmL | |
| 803A4300 | 1-Sliding T handle 300mmL | |
| 815A4315 | 1-105° L handle 315mmL | |



8pc Impact adapter (pin type)

| | | |
|-----------------------|--|-------|
| K4088 | | |
| Part no. | 12/41.2/42.2/1.4' | 3430g |
| 809 32MPP...812MPP | Content: 1/2"DR. 8-Impact Adapter (pin type) 3/8"(F)x1/4"(M); 3/8"(F)x1/2"(M); 1/2"(F)x3/8"(M); 1/2"(F)x3/4"(M); 3/4"(F)x1/2"(M); 3/4"(F)x1"(M); 1"(F)x3/4"(M); 1"(F)x1-1/2"(M) | |

NEW



8pc 1/2" 6pt. Impact socket set

| | | | |
|---------------|---|-------------------|-----|
| K40810 | | | |
| Part no. | Socket | 24/24.0/25.0/1.5' | 1kg |
| 445 10...24 | Content: 1/2" DR. 8-6pt. Impact socket 10, 12, 13, 14, 17, 19, 22, 24mm | | |

NEW



9pc 1/2" Impact deep socket & Hex impact socket bit set

| | | |
|----------------|---|-------|
| 40912 | | |
| Part no. | 6/22.7/23.7/2.6' | 3790g |
| 44885 27...36 | Content: 1/2"DR. 6-12pt. Impact deep socket 27; 30; 32; 34; 35; 36 mm | |
| 244060 14...19 | 3-Hex impact socket bit (one-piece) 14; 17; 19 mm | |



9pc Wheel nut impact socket set

| | | | |
|-----------------|---|------------------|-------|
| K4099 | | | |
| Part no. | Socket | 6/15.3/16.3/0.8' | 2543g |
| 44585 14C...27C | Content: 1/2"DR. 9- Wheel nut 6pt. flank impact socket (85mmL) 14; 15; 17; 19; 21; 22; 23; 24; 27 mm | | |



10pc 1/2" Impact deep socket set (MM)

| | | | |
|---------------|---|-------------------|-------|
| 4107 | | | |
| Part no. | Socket | 10/16.9/27.9/0.7' | 2690g |
| 44585 11...24 | Content: 1/2"DR. 10-Impact deep socket 11; 12; 13; 14; 16; 17; 19; 21; 22; 24 mm | | |

10pc 1/2" Impact deep socket set (SAE)

| | | | |
|------------------|--|-------------------|-------|
| 4107S | | | |
| Part no. | Socket | 10/16.9/27.9/0.7' | 2690g |
| 44585 5.16...3.4 | Content: 1/2"DR. 10-Impact deep socket 3/8"; 7/16"; 1/2"; 9/16"; 5/8"; 11/16"; 3/4"; 13/16"; 7/8"; 15/16" | | |



10pc 1/2" star impact socket bit set

| | | | |
|----------------|--|--------------------|------|
| 4108 | | | |
| Part no. | Bit | 20/18.0/19.0/0.82' | 900g |
| 246055 20...70 | Content: 1/2"DR. 10-Star impact socket bit T20; T25; T27; T30; T40; T45; T50; T55; T60; T70 (55mmL) | | |



10pc 1/2" Hex impact socket bit set

| | | | |
|----------------|---|--------------------|-------|
| 41012 | | | |
| Part no. | Bit | 20/23.7/24.7/0.82' | 1185g |
| 244060 04...19 | Content: 1/2"DR. 10-Hex impact socket bit (one-piece) 4; 5; 6; 7; 8; 10; 12; 14; 17; 19 mm (60mmL) | | |



10pc 1/2" Impact socket set (MM)

| | | | |
|-------------|--|-------------------|-------|
| 4109 | | | |
| Part no. | Socket | 20/25.0/26.0/0.6' | 1250g |
| 445 11...24 | Content: 1/2"DR. 10-Impact socket 11; 12; 13; 14; 16; 17; 19; 21; 22; 24 mm | | |

10pc 1/2" Impact socket set (SAE)

| | | | |
|-----------------|---|-------------------|-------|
| 4109S | | | |
| Part no. | Socket | 20/25.0/26.0/0.6' | 1250g |
| 445 3.8...15.16 | Content: 1/2"DR. 10-Impact socket 3/8"; 7/16"; 1/2"; 9/16"; 5/8"; 11/16"; 3/4"; 13/16"; 7/8"; 15/16" | | |



10pc 1/2" Star impact socket bit set

| | | | |
|----------------|--|--------------------|-------|
| 41013 | | | |
| Part no. | Bit | 20/20.2/21.2/0.82' | 1010g |
| 246060 20...70 | Content: 1/2"DR. 10-Star impact socket bit (one-piece) T20; T25; T27; T30; T40; T45; T50; T55; T60; T70 (60mmL) | | |



11pc 1/2" Star impact socket set

| 4117 | | | |
|-------------|--|--------------------|-------|
| Part no. | Socket | 20/23.7/24.7/0.82' | 1185g |
| 446 06...24 | Content: 1/2"DR. 10-Star impact socket E6; E7; E8; E10; E12; E14; E16; E18; E20; E22; E24 | | |



11pc 1/2" Impact wrench socket set

| 4118-2 | | | |
|---------------|---|------------------|-------|
| Part no. | Socket | 6/15.9/16.9/1.2' | 2650g |
| 445 10...17 | Content: 1/2"DR. 10-Impact socket 10; 11; 12; 13; 14; 16; 17 mm | | |
| 82442 | 1-Impact ratchet | | |
| 8044075MPB | 1-Extension 75mmL | | |
| 809QC | 1-Impact Quick connector (20MP) | | |
| 638M | 1-Mini oiler | | |



11pc 1/2" Impact wrench socket set

| 4118 | | | |
|-------------|---|------------------|-------|
| Part no. | Socket | 6/15.9/16.9/1.2' | 2650g |
| 445 10...17 | Content: 1/2"DR. 10-Impact socket 10; 11; 12; 13; 14; 16; 17 mm | | |
| 82441 | 1-Impact ratchet | | |
| 8044075MPB | 1-Impact Extension 75mmL | | |
| 809QC | 1-Quick connector (20MP) | | |
| 638M | 1-Mini oiler | | |



11pc 1/2" Impact deep socket set

| 4119 | | | |
|---------------|--|------------------|-------|
| Part no. | Socket | 6/24.8/25.8/0.9' | 4133g |
| 44585 12...32 | Content: 1/2"DR. 11-6pt. Flank impact deep socket 12; 14; 17; 19; 21; 22; 23; 24; 27; 30; 32 mm | | |



15pc 1/2" Impact wrench socket set

| 4142 | | | |
|-------------|--|------------------|-------|
| Part no. | Socket | 4/20.0/21.0/1.2' | 5000g |
| 445 10...24 | Content: 1/2"DR. 10-Impact socket 10; 11; 12; 13; 14; 17; 19; 21; 22; 24 mm | | |
| 82541 | 1-Impact wrench | | |
| 8044125MPB | 1-Impact extension 125mmL | | |
| 80541MPB | 1-Impact universal joint | | |
| 809QC | 1-Quick connector (20MP) | | |
| 638M | 1-Mini oiler | | |



15pc 1/2" Impact wrench socket set

| 4142-3 | | | |
|---------------|--|------------------|-------|
| Part no. | Socket | 4/20.0/21.0/1.2' | 5000g |
| 445 10...24 | Content: 1/2"DR. 10-Impact socket 10; 11; 12; 13; 14; 17; 19; 21; 22; 24 mm | | |
| 82543 | 1-Mini impact wrench | | |
| 8044125MPB | 1-Impact extension 125mmL | | |
| 80541MPB | 1-Impact universal joint | | |
| 809QC | 1-Quick connector (20MP) | | |
| 638M | 1-Mini oiler | | |



15pc 1/2" Impact wrench socket set

| 4142B | | | |
|--------------|--|------------------|-------|
| Part no. | Socket | 4/20.0/21.0/1.2' | 5000g |
| 445 10...24 | Content: 1/2"DR. 10-Impact socket 10; 11; 12; 13; 14; 17; 19; 21; 22; 24 mm | | |
| 82542 | 1-Impact wrench | | |
| 8044125MPB | 1-Impact extension 125mmL | | |
| 80541MPB | 1-Impact universal joint | | |
| 809QC | 1-Quick connector (20MP) | | |
| 638M | 1-Mini oiler | | |



15pc 1/2" Impact wrench socket set

| 4142-4 | | | |
|---------------|--|------------------|-------|
| Part no. | Socket | 4/20.0/21.0/1.2' | 5000g |
| 445 10...24 | Content: 1/2"DR. 10-Impact socket 10; 11; 12; 13; 14; 17; 19; 21; 22; 24 mm | | |
| 82544 | 1-Mini composite impact wrench | | |
| 8044125MPB | 1-Impact extension 125mmL | | |
| 80541MPB | 1-Impact universal joint | | |
| 809QC | 1-Quick connector (20MP) | | |
| 638M | 1-Mini oiler | | |



19pc 1/2" Impact socket set

| 4193 | | | |
|-------------|---|------------------|-------|
| Part no. | Socket | 6/18.8/19.8/0.9' | 3130g |
| 445 10...32 | Content: 1/2"DR. 18- 6pt. Flank impact socket 10; 11; 12; 13; 14; 15; 16; 17; 18; 19; 21; 22; 23; 24; 26; 27; 30; 32 mm | | |
| 8044125MPB | 1- Impact extension 125mmL | | |

NEW



21pc 1/2" Impact wrench socket set

| 4215 | | |
|-----------------|---|-------|
| Part no. | 3/20.4/21.4/1' | 6796g |
| 445 10...24 | Content: 1/2"DR. 5-6pt. Flank impact socket 10; 13; 17; 19; 24 mm | |
| 44585 | 3-6pt. Flank impact thin-wall deep socket 17; 19; 21mm (85mmL) | |
| 17TH...21TH | 5-Wheel nut 6pt. Flank impact socket (colored) 15; 17; 19; 21; 23 mm | |
| 44585 15C...23C | 1-Impact extension (ball type) 125mm | |
| 8044125MPB | 1-Universal joint (ball type) | |
| 80541MPB | 1-Super duty impact ratchet wrench | |
| 82442 | 1-Impact wrench (with grip) | |
| 825410 | 1-Pin 20L-φ3.0 | |
| P2030 | 1-Pin 25L-φ3.0 | |
| P2530 | 1-Ring φ19-φ3.5 | |
| R1935 | 1-Ring φ24-φ3.5 | |
| R2435 | | |

NEW



21pc 1/2" DR. Impact wrench & socket set

| 4216 | | |
|---------------|--|-------|
| Part no. | 3/20.4/21.4/1.5' | 6796g |
| 44585 10...27 | Content: 1/2"DR. 14-6pt. Flank impact deep socket 10; 11; 12; 13; 14; 16; 17; 19; 21; 22; 23; 24; 26; 27 mm | |
| 8044125MPP | 1-Impact extension 5" (pin type) | |
| 80541MPP | 1-Impact universal joint (pin type) | |
| 82549 | 1-1/2"DR. Impact wrench | |
| P2030 | 1-Pin 20L- Ø 3.0 | |
| P2530 | 1-Pin 25L- Ø 3.0 | |
| R1935 | 1-Ring Ø 19- Ø 3.5 | |
| R2435 | 1-Ring Ø 24- Ø 3.5 | |

NEW



29pc 1/2" Impact wrench socket set

| 4293 | | |
|-----------------|--|-------|
| Part no. | 3/22.3/23.5/1.5' | 7433g |
| 445 10...32 | Content: 1/2"DR. 16-Impact socket 10; 11; 12; 13; 14; 15; 16; 17; 18; 19; 21; 22; 24; 27; 30; 32 mm | |
| 44585 10...18 | 4-6pt. Flank impact deep socket 10; 13; 16; 18 mm | |
| 44585 17C...21C | 3-Wheel nut 6pt. flank impact socket (85mmL) 17; 19; 21 mm | |
| 8044125MPB | 1-Impact extension (ball type) 5" | |
| 825410 | 1-Impact wrench (with grip) | |
| P2030 | 1-Pin 20L-φ3.0 | |
| P2530 | 1-Pin 25L-φ3.0 | |
| R1935 | 1-Ring φ19-φ3.5 | |
| R2435 | 1-Ring φ24-φ3.5 | |

NEW



20pc 1/2"DR. Impact socket bit set (one-piece)

| 4205 | | |
|----------------|---|-------|
| Part no. | 6/11.4/12.4/0.9' | 1900g |
| 244060 04...19 | Content: 1/2"DR. 10-Hex impact socket bit (60mmL) 4; 5; 6; 7; 8; 10; 12; 14; 17; 19mm | |
| 246060 20...70 | 10-Star impact socket bit (60mmL) T20; T25; T27; T30; T40; T45; T50; T55; T60; T70 | |



14pc 1/2" Impact socket set

| 41451S | | | |
|-----------------------|--|-------------------|------|
| Part no. | Socket | 1/23.0/24.0/1.25' | 23kg |
| 50141S 445 10...32 | Content: 1/2"DR. 1- Short socket storage 145- 6pt. Flank impact socket | | |
| | Each 11pcs - 10; 11; 12; 13; 14; 16 mm | | |
| | Each 10pcs - 17; 19 mm | | |
| | Each 9pcs - 21 mm | | |
| | Each 8pcs - 22; 23; 24 mm | | |
| | Each 7pcs - 26; 27 mm | | |
| | Each 6pcs - 30; 32 mm | | |

14pc 1/2" Impact deep socket set

| 41451D | | | |
|-------------------------|--|-------------------|------|
| Part no. | Socket | 1/35.0/36.0/1.25' | 35kg |
| 50141D 44585 10...32 | Content: 1/2"DR. 1- Deep socket storage 145- 6pt. Flank deep impact socket | | |
| | Each 11pcs - 10; 11; 12; 13; 14; 16 mm | | |
| | Each 10pcs - 17; 19 mm | | |
| | Each 9pcs - 21 mm | | |
| | Each 8pcs - 22; 23; 24 mm | | |
| | Each 7pcs - 26; 27 mm | | |
| | Each 6pcs - 30; 32 mm | | |

3-layer socket display shelf with 275pc tools

| 50121E-275 | |
|-------------------|---|
| 50121 | Content: 1-3-layer socket display shelf 1/2"DR. Part: 152-6pt. Impact socket |
| 445 10...41 | Each 10pcs - 10; 12; 13; 14; 15; 16; 17; 18; 19; 21; 22 mm |
| | Each 9pcs - 24 mm |
| | Each 8pcs - 27 mm |
| | Each 7pcs - 30; 32 mm |
| | Each 6pcs - 36 mm |
| | Each 5pcs - 41 mm |
| 44585 10...36 | 123-6pt. Impact deep socket |
| | Each 10pcs - 10; 12; 13; 14; 15; 16 mm |
| | Each 8pcs - 17; 18; 19 mm |
| | Each 7pcs - 21; 22 mm |
| | Each 6pcs - 24 mm |
| | Each 5pcs - 27; 30; 32 mm |
| | Each 4pcs - 36 mm |

3-layer socket display shelf with 271pc tools (SAE)

| 50121F-271 | |
|--------------------|---|
| 50121 | Content: 1-3-layer socket display shelf 1/2"DR. Part: 149-6pt. Impact socket |
| 445 5.16...1.5.16 | Each 10pcs - 5/16"; 3/8"; 7/16"; 1/2"; 9/16"; 5/8"; 11/16"; 3/4"; 13/16"; 7/8" |
| | Each 9pcs - 15/16"; 1" |
| | Each 7pcs - 1-1/16" |
| | Each 6pcs - 1-1/8"; 1-3/16"; 1-1/4"; 1-5/16" |
| 44585 5.16...1.1.4 | 122-6pt. Impact deep socket |
| | Each 10pcs - 5/16"; 3/8"; 7/16"; 1/2"; 9/16"; 5/8" |
| | Each 8pcs - 11/16"; 3/4" |
| | Each 7pcs - 13/16"; 7/8" |
| | Each 6pcs - 15/16"; 1" |
| | Each 5pcs - 1-1/16"; 1-1/8"; 1-3/16"; 1-1/4" |



1/2" Phillips impact socket bit

| 241 | | | | |
|------------|------|----|-----|--------|
| Part no. | size | mm | g | pc/box |
| 241552 | PH.2 | 55 | 104 | 10 |
| 241553 | PH.3 | 55 | 104 | 10 |
| 241554 | PH.4 | 55 | 104 | 10 |

NEW



1/2" Phillips impact socket bit(one piece)

| 241060 | | | | |
|---------------|------|----|----|--------|
| Part no. | size | mm | g | pc/box |
| 2410601 | PH.1 | 60 | 69 | 10 |
| 2410602 | PH.2 | 60 | 71 | 10 |
| 2410603 | PH.3 | 60 | 74 | 10 |



1/2" Pozidriv impact socket bit

| 242 | | | | |
|------------|------|----|-----|--------|
| Part no. | size | mm | g | pc/box |
| 242552 | PZ.2 | 55 | 104 | 10 |
| 242553 | PZ.3 | 55 | 104 | 10 |
| 242554 | PZ.4 | 55 | 104 | 10 |



1/2" Slotted impact socket bit

| 243 | | | | |
|------------|--------|----|-----|--------|
| Part no. | size | mm | g | pc/box |
| 2435508 | 1.2x8 | 55 | 102 | 10 |
| 2435510 | 1.6x10 | 55 | 104 | 10 |
| 2435512 | 2.0x12 | 55 | 104 | 10 |
| 2435514 | 2.5x14 | 55 | 106 | 10 |
| 2435516 | 2.5x16 | 55 | 108 | 10 |



1/2" Hex impact socket bit (one-piece)

| 244060 | | | | |
|-----------------|--------|----|-----|--------|
| Part no. | size | mm | g | pc/box |
| 24406004 | 4 | 60 | 70 | 10 |
| 24406005 | 5 | 60 | 70 | 10 |
| 24406006 | 6 | 60 | 74 | 10 |
| 24406007 | 7 | 60 | 74 | 10 |
| 24406008 | 8 | 60 | 76 | 10 |
| 24406010 | 10 | 60 | 94 | 10 |
| 24406012 | 12 | 60 | 103 | 10 |
| 24406014 | 14 | 60 | 115 | 10 |
| 24406016 NEW | 16 | 60 | 148 | 10 |
| 24406017 | 17 | 60 | 150 | 10 |
| 24406019 | 19 | 60 | 154 | 10 |
| 24406021 NEW | 21 | 60 | 192 | 10 |
| 24406022 NEW | 22 | 60 | 165 | 10 |
| 24406024 NEW | 24 | 60 | 175 | 10 |
| 24407804 | 4 | 78 | 72 | 10 |
| 24407805 | 5 | 78 | 75 | 10 |
| 24407806 | 6 | 78 | 81 | 10 |
| 24407807 | 7 | 78 | 84 | 10 |
| 24407808 | 8 | 78 | 87 | 10 |
| 24407810 | 10 | 78 | 109 | 10 |
| 24407812 | 12 | 78 | 124 | 10 |
| 24407813 NEW | 13 | 78 | 132 | 10 |
| 24407814 | 14 | 78 | 140 | 10 |
| 24407817 | 17 | 78 | 180 | 10 |
| 24407819 | 19 | 78 | 204 | 10 |
| 24407822 | 22 | 78 | 280 | 10 |
| 24407824 | 24 | 78 | 320 | 10 |
| 2440603.16 NEW | 3/16" | 60 | 66 | 10 |
| 2440601.4 NEW | 1/4" | 60 | 72 | 10 |
| 2440605.16 NEW | 5/16" | 60 | 78 | 10 |
| 2440603.8 NEW | 3/8" | 60 | 85 | 10 |
| 2440607.16 NEW | 7/16" | 60 | 95 | 10 |
| 2440601.2 NEW | 1/2" | 60 | 102 | 10 |
| 2440609.16 NEW | 9/16" | 60 | 111 | 10 |
| 2440605.8 NEW | 5/8" | 60 | 146 | 10 |
| 24406011.16 NEW | 11/16" | 60 | 159 | 10 |
| 2440603.4 NEW | 3/4" | 60 | 154 | 10 |
| 24406013.16 NEW | 13/16" | 60 | 192 | 10 |



1/2" Hex impact socket bit

| 244 | | <i>l</i> | | |
|-------------------------|------|----------|-----|--------|
| Part no. | size | mm | g | pc/box |
| 24405503 | 3 | 55 | 104 | 10 |
| 24405504 | 4 | 55 | 104 | 10 |
| 24405505 | 5 | 55 | 106 | 10 |
| 24405506 | 6 | 55 | 106 | 10 |
| 24405507 | 7 | 55 | 106 | 10 |
| 24405508 | 8 | 55 | 112 | 10 |
| 24405509 ^{NEW} | 9 | 55 | 113 | 10 |
| 24405510 | 10 | 55 | 114 | 10 |
| 24405512 | 12 | 55 | 122 | 10 |
| 24406514 | 14 | 65 | 186 | 10 |
| 24407017 | 17 | 70 | 232 | 10 |
| 24407019 | 19 | 70 | 272 | 10 |
| 24410005 | 5 | 100 | 136 | 10 |
| 24410006 | 6 | 100 | 136 | 10 |
| 24410007 | 7 | 100 | 136 | 10 |
| 24410008 | 8 | 100 | 138 | 10 |



1/2" Star impact socket bit

| 246 | | <i>l</i> | | |
|----------|------|----------|-----|--------|
| Part no. | size | mm | g | pc/box |
| 24605520 | T20 | 55 | 106 | 10 |
| 24605525 | T25 | 55 | 106 | 10 |
| 24605527 | T27 | 55 | 106 | 10 |
| 24605530 | T30 | 55 | 108 | 10 |
| 24605540 | T40 | 55 | 108 | 10 |
| 24605545 | T45 | 55 | 108 | 10 |
| 24605550 | T50 | 55 | 112 | 10 |
| 24605555 | T55 | 55 | 122 | 10 |
| 24605560 | T60 | 55 | 124 | 10 |
| 24605570 | T70 | 55 | 142 | 10 |
| 24610040 | T40 | 100 | 138 | 10 |
| 24610045 | T45 | 100 | 140 | 10 |
| 24610050 | T50 | 100 | 142 | 10 |
| 24610055 | T55 | 100 | 160 | 10 |
| 24610060 | T60 | 100 | 162 | 10 |



1/2" Spline impact socket bit

| 248 | | <i>l</i> | | |
|-------------------------|------|----------|-----|--------|
| Part no. | size | mm | g | pc/box |
| 24805505 | M5 | 55 | 104 | 10 |
| 24805506 | M6 | 55 | 104 | 10 |
| 24805508 | M8 | 55 | 104 | 10 |
| 24805509 ^{NEW} | M9 | 55 | 104 | 10 |
| 24805510 | M10 | 55 | 106 | 10 |
| 24805512 | M12 | 55 | 114 | 10 |
| 24810005 | M5 | 100 | 146 | 10 |
| 24810006 | M6 | 100 | 148 | 10 |
| 24810008 | M8 | 100 | 148 | 10 |
| 24810010 | M10 | 100 | 150 | 10 |
| 24810012 | M12 | 100 | 158 | 10 |



1/2" DR. 6pt. Flank impact socket

| 445 | | <i>l</i> | | |
|--------------------------|---------|----------|-----|--------|
| Part no. | size | mm | g | pc/box |
| 44508 | 8 | 38 | 71 | 10 |
| 44509 | 9 | 38 | 71 | 10 |
| 44510 | 10 | 38 | 72 | 10 |
| 44511 | 11 | 38 | 72 | 10 |
| 44512 | 12 | 38 | 74 | 10 |
| 44513 | 13 | 38 | 77 | 10 |
| 44514 | 14 | 38 | 80 | 10 |
| 44515 | 15 | 38 | 82 | 10 |
| 44516 | 16 | 38 | 85 | 10 |
| 44517 | 17 | 38 | 89 | 10 |
| 44518 | 18 | 38 | 89 | 10 |
| 44519 | 19 | 38 | 102 | 10 |
| 44520 | 20 | 38 | 124 | 10 |
| 44521 | 21 | 38 | 124 | 10 |
| 44522 | 22 | 40 | 148 | 10 |
| 44523 | 23 | 40 | 148 | 10 |
| 44524 | 24 | 40 | 154 | 10 |
| 44525 | 25 | 45 | 160 | 10 |
| 44526 | 26 | 45 | 181 | 10 |
| 44527 | 27 | 45 | 181 | 10 |
| 44528 | 28 | 48 | 197 | 10 |
| 44529 | 29 | 48 | 200 | 10 |
| 44530 | 30 | 48 | 218 | 10 |
| 44531 | 31 | 48 | 218 | 10 |
| 44532 | 32 | 48 | 218 | 10 |
| 44533 | 33 | 50 | 223 | 10 |
| 44534 | 34 | 52 | 230 | 10 |
| 44535 | 35 | 52 | 268 | 10 |
| 44536 | 36 | 52 | 289 | 10 |
| 44538 | 38 | 54 | 314 | 10 |
| 44539 | 39 | 54 | 350 | 10 |
| 44541 | 41 | 57 | 388 | 10 |
| 44546 ^{NEW} | 46 | 57 | 572 | 10 |
| 4455.16 | 5/16" | 38 | 70 | 10 |
| 4453.8 | 3/8" | 38 | 72 | 10 |
| 4457.16 | 7/16" | 38 | 74 | 10 |
| 4451.2 | 1/2" | 38 | 77 | 10 |
| 4459.16 | 9/16" | 38 | 77 | 10 |
| 4455.8 | 5/8" | 38 | 85 | 10 |
| 44511.16 | 11/16" | 38 | 104 | 10 |
| 4453.4 | 3/4" | 38 | 120 | 10 |
| 44513.16 | 13/16" | 38 | 130 | 10 |
| 4457.8 | 7/8" | 40 | 147 | 10 |
| 44515.16 | 15/16" | 45 | 153 | 10 |
| 4451.0 | 1" | 45 | 169 | 10 |
| 4451.1.16 | 1-1/16" | 45 | 173 | 10 |
| 4451.1.8 | 1-1/8" | 48 | 193 | 10 |
| 4451.3.16 | 1-3/16 | 48 | 201 | 10 |
| 4451.1.4 | 1-1/4" | 48 | 210 | 10 |
| 4451.5.16 ^{NEW} | 1-5/16" | 50 | 285 | 10 |
| 4451.3.8 ^{NEW} | 1-3/8" | 50 | 311 | 10 |
| 4451.7.16 ^{NEW} | 1-7/16" | 50 | 354 | 10 |
| 4451.1.2 ^{NEW} | 1-1/2" | 50 | 373 | 10 |

NEW



1/2" Spline impact socket bit (one-piece)

| 248060 | | <i>l</i> | | |
|----------|------|----------|-----|--------|
| Part no. | size | mm | g | pc/box |
| 24806008 | M8 | 60 | 74 | 10 |
| 24806010 | M10 | 60 | 85 | 10 |
| 24806012 | M12 | 60 | 93 | 10 |
| 24807812 | M12 | 78 | 107 | 10 |
| 24807814 | M14 | 78 | 110 | 10 |
| 24807816 | M16 | 78 | 115 | 10 |
| 24807818 | M18 | 78 | 118 | 10 |



1/2" DR. Star impact socket bit (one-piece)

| 246 | | <i>l</i> | | |
|----------|------|----------|----|--------|
| Part no. | size | mm | g | pc/box |
| 24620 | T20 | 40 | 61 | 10 |
| 24625 | T25 | 40 | 61 | 10 |
| 24627 | T27 | 40 | 61 | 10 |
| 24630 | T30 | 40 | 61 | 10 |
| 24640 | T40 | 40 | 62 | 10 |
| 24645 | T45 | 40 | 62 | 10 |
| 24650 | T50 | 40 | 64 | 10 |
| 24655 | T55 | 40 | 69 | 10 |
| 24660 | T60 | 40 | 74 | 10 |
| 24670 | T70 | 40 | 86 | 10 |



1/2" DR. Star impact socket bit (one-piece)

| 246060 | | <i>l</i> | | |
|-------------------------|------|----------|-----|--------|
| Part no. | size | mm | g | pc/box |
| 24606010 ^{NEW} | T10 | 60 | 62 | 10 |
| 24606015 ^{NEW} | T15 | 60 | 62 | 10 |
| 24606020 | T20 | 60 | 63 | 10 |
| 24606025 | T25 | 60 | 63 | 10 |
| 24606027 | T27 | 60 | 63 | 10 |
| 24606030 | T30 | 60 | 63 | 10 |
| 24606040 | T40 | 60 | 67 | 10 |
| 24606045 | T45 | 60 | 71 | 10 |
| 24606050 | T50 | 60 | 74 | 10 |
| 24606055 | T55 | 60 | 88 | 10 |
| 24606060 | T60 | 60 | 99 | 10 |
| 24606070 | T70 | 60 | 108 | 10 |



1/2" DR. Square impact socket

| 44114 | | <i>l</i> | | |
|----------|------|----------|----|--------|
| Part no. | size | mm | g | pc/box |
| 44114 | 14 | 40 | 96 | 10 |



1/2" DR. 6pt. Flank impact middle deep socket

| 44552 | | <i>l</i> | | |
|--------------|------|----------|-----|--------|
| Part no. | size | mm | g | pc/box |
| 4455214 | 14 | 52 | 100 | 10 |
| 4455217 | 17 | 52 | 125 | 10 |
| 4455219 | 19 | 52 | 142 | 10 |
| 4455221 | 21 | 52 | 161 | 10 |
| 4455223 | 23 | 52 | 174 | 10 |
| 4455224 | 24 | 52 | 185 | 10 |

1/2" DR. 6pt. Flank impact thin-wall middle deep socket

| 44552..TH | | <i>l</i> | | |
|------------------|------|----------|-----|--------|
| Part no. | size | mm | g | pc/box |
| 4455214TH | 14 | 52 | 86 | 10 |
| 4455217TH | 17 | 52 | 99 | 10 |
| 4455219TH | 19 | 52 | 118 | 10 |
| 4455221TH | 21 | 52 | 130 | 10 |
| 4455223TH | 23 | 52 | 144 | 10 |
| 4455224TH | 24 | 52 | 152 | 10 |



1/2" DR. Wheel nut 6pt. flank impact socket

| 445150..C | | <i>l</i> | | | |
|------------------|------|----------|-----|--------|--------|
| Part no. | size | mm | g | color | pc/box |
| 44515017C | 17 | 150 | 365 | blue | 1 |
| 44515019C | 19 | 150 | 395 | yellow | 1 |
| 44515021C | 21 | 150 | 420 | red | 1 |



1/2" DR. 6pt. Flank impact deep socket

| 44585 | | <i>l</i> | | |
|--------------|--------|----------|-----|--------|
| Part no. | size | mm | g | pc/box |
| 4458508 | 8 | 85 | 110 | 10 |
| 4458509 | 9 | 85 | 120 | 10 |
| 4458510 | 10 | 85 | 123 | 10 |
| 4458511 | 11 | 85 | 135 | 10 |
| 4458512 | 12 | 85 | 147 | 10 |
| 4458513 | 13 | 85 | 154 | 10 |
| 4458514 | 14 | 85 | 178 | 10 |
| 4458515 | 15 | 85 | 181 | 10 |
| 4458516 | 16 | 85 | 204 | 10 |
| 4458517 | 17 | 85 | 209 | 10 |
| 4458518 | 18 | 85 | 215 | 10 |
| 4458519 | 19 | 85 | 242 | 10 |
| 4458520 | 20 | 85 | 277 | 10 |
| 4458521 | 21 | 85 | 279 | 10 |
| 4458522 | 22 | 85 | 299 | 10 |
| 4458523 | 23 | 85 | 299 | 10 |
| 4458524 | 24 | 85 | 336 | 10 |
| 4458525 | 25 | 85 | 366 | 10 |
| 4458526 | 26 | 85 | 367 | 10 |
| 4458527 | 27 | 85 | 367 | 10 |
| 4458528 | 28 | 85 | 377 | 10 |
| 4458529 | 29 | 85 | 393 | 10 |
| 4458530 | 30 | 85 | 400 | 10 |
| 4458531 | 31 | 85 | 405 | 10 |
| 4458532 | 32 | 85 | 458 | 10 |
| 4458533 | 33 | 85 | 466 | 10 |
| 4458534 | 34 | 85 | 475 | 10 |
| 4458535 | 35 | 85 | 489 | 10 |
| 4458536 | 36 | 85 | 499 | 10 |
| 4458538 | 38 | 85 | 518 | 5 |
| 4458541 | 41 | 85 | 545 | 5 |
| 445855.16 | 5/16" | 85 | 110 | 10 |
| 445853.8 | 3/8" | 85 | 127 | 10 |
| 445857.16 | 7/16" | 85 | 133 | 10 |
| 445851.2 | 1/2" | 85 | 157 | 10 |
| 445859.16 | 9/16" | 85 | 171 | 10 |
| 445855.8 | 5/8" | 85 | 201 | 10 |
| 4458511.16 | 11/16" | 85 | 211 | 10 |
| 445853.4 | 3/4" | 85 | 232 | 10 |
| 4458513.16 | 13/16" | 85 | 274 | 10 |
| 445857.8 | 7/8" | 85 | 305 | 10 |
| 4458515.16 | 15/16" | 85 | 341 | 10 |

| 44585 | | <i>l</i> | | |
|--------------------------------|---------|----------|-----|--------|
| Part no. | size | mm | g | pc/box |
| 445851.0 | 1" | 85 | 350 | 10 |
| 445851.1.16 | 1-1/16" | 85 | 360 | 10 |
| 445851.1.8 | 1-1/8" | 85 | 372 | 10 |
| 445851.3.16 | 1-3/16" | 85 | 393 | 10 |
| 445851.1.4 | 1-1/4" | 85 | 418 | 10 |
| 445851.5.16 <small>NEW</small> | 1-5/16" | 85 | 504 | 10 |
| 445851.3.8 <small>NEW</small> | 1-3/8" | 85 | 522 | 10 |
| 445851.7.16 <small>NEW</small> | 1-7/16" | 85 | 625 | 10 |
| 445851.1.2 <small>NEW</small> | 1-1/2" | 85 | 623 | 5 |

1/2" DR. 6pt. Flank impact thin-wall deep socket

| 44585..TH | | | <i>l</i> | | |
|------------------|------|----|----------|-----|--------|
| Part no. | size | mm | mm | g | pc/box |
| 4458517 TH | 17 | 24 | 85 | 173 | 10 |
| 4458519 TH | 19 | 26 | 85 | 219 | 10 |
| 4458521 TH | 21 | 29 | 85 | 240 | 10 |



1/2" DR. Wheel nut 6pt. flank impact socket

| 44585..C | | <i>l</i> | | | |
|-----------------|------|----------|-----|--------|--------|
| Part no. | size | mm | g | color | pc/box |
| 4458514C | 14 | 85 | 175 | black | 1 |
| 4458515C | 15 | 85 | 180 | gold | 1 |
| 4458517C | 17 | 85 | 225 | blue | 1 |
| 4458519C | 19 | 85 | 240 | yellow | 1 |
| 4458521C | 21 | 85 | 260 | red | 1 |
| 4458522C | 22 | 85 | 305 | green | 1 |
| 4458523C | 23 | 85 | 310 | purple | 1 |
| 4458524C | 24 | 85 | 312 | green | 1 |
| 4458527C | 27 | 85 | 362 | red | 1 |



1/2" DR. Star impact socket

| 446 | | <i>l</i> | | |
|------------|--------|----------|-----|--------|
| Part no. | Socket | mm | g | pc/box |
| 44606 | E6 | 38 | 62 | 10 |
| 44607 | E7 | 38 | 62 | 10 |
| 44608 | E8 | 38 | 62 | 10 |
| 44610 | E10 | 38 | 74 | 10 |
| 44611 | E11 | 38 | 74 | 10 |
| 44612 | E12 | 38 | 77 | 10 |
| 44614 | E14 | 38 | 77 | 10 |
| 44616 | E16 | 38 | 77 | 10 |
| 44618 | E18 | 38 | 124 | 10 |
| 44620 | E20 | 38 | 126 | 10 |
| 44622 | E22 | 38 | 132 | 10 |
| 44624 | E24 | 42 | 155 | 10 |



1/2" DR. 12pt. Impact socket

| 448 | | <i>l</i> | | |
|--------------------------|--------|----------|-----|--------|
| Part no. | Socket | mm | g | pc/box |
| 44808 | 8 | 38 | 74 | 10 |
| 44810 | 10 | 38 | 74 | 10 |
| 44811 | 11 | 38 | 74 | 10 |
| 44812 | 12 | 38 | 74 | 10 |
| 44813 | 13 | 38 | 76 | 10 |
| 44814 | 14 | 38 | 76 | 10 |
| 44815 | 15 | 38 | 81 | 10 |
| 44816 | 16 | 38 | 84 | 10 |
| 44817 | 17 | 38 | 86 | 10 |
| 44818 | 18 | 38 | 86 | 10 |
| 44819 | 19 | 38 | 102 | 10 |
| 44820 <small>NEW</small> | 20 | 38 | 117 | 10 |
| 44821 | 21 | 38 | 120 | 10 |
| 44822 | 22 | 43 | 147 | 10 |
| 44823 | 23 | 43 | 147 | 10 |
| 44824 | 24 | 43 | 148 | 10 |
| 44826 | 26 | 43 | 168 | 10 |
| 44827 | 27 | 43 | 168 | 10 |
| 44828 | 28 | 45 | 185 | 10 |
| 44830 | 30 | 45 | 204 | 10 |
| 44832 | 32 | 45 | 206 | 10 |



1/2"DR. 12pt. Impact deep socket

| Part no. | Socket | mm | g | pc/box |
|----------------------------|--------|----|-----|--------|
| 4488510 | 10 | 85 | 123 | 10 |
| 4488512 | 12 | 85 | 144 | 10 |
| 4488514 | 14 | 85 | 174 | 10 |
| 4488516 <small>NEW</small> | 16 | 85 | 204 | 10 |
| 4488517 | 17 | 85 | 222 | 10 |
| 4488519 | 19 | 85 | 244 | 10 |
| 4488521 <small>NEW</small> | 21 | 85 | 261 | 10 |
| 4488522 <small>NEW</small> | 22 | 85 | 319 | 10 |
| 4488524 <small>NEW</small> | 24 | 85 | 329 | 10 |
| 4488527 <small>NEW</small> | 27 | 85 | 377 | 10 |
| 4488530 | 30 | 85 | 367 | 10 |
| 4488532 | 32 | 85 | 405 | 10 |
| 4488533 <small>NEW</small> | 33 | 85 | 466 | 10 |
| 4488534 <small>NEW</small> | 34 | 85 | 507 | 10 |
| 4488535 <small>NEW</small> | 35 | 85 | 485 | 10 |
| 4488536 | 36 | 85 | 479 | 10 |



1/2"DR. Universal joint (pin type)

| Part no. | mm | g | pc/box |
|----------|----|-----|--------|
| 80541MPP | 75 | 141 | 10 |



1/2"DR. Universal joint (ball type)

| Part no. | mm | g | pc/box |
|----------|----|-----|--------|
| 80541MPB | 75 | 139 | 10 |



1/2"DR. Impact locking extension (ball type)

| Part no. | mm | g | pc/box |
|------------|---------|-----|--------|
| 8084075MPB | 75-3" | 170 | 10 |
| 8084125MPB | 125-5" | 250 | 10 |
| 8084250MPB | 250-10" | 450 | 5 |



1/2"DR. Adaptor (pin type)

| Part no. | Size | mm | g | pc/box |
|----------|-----------------|----|-----|--------|
| 80943MPP | 1/2"(F)x3/8"(M) | 38 | 70 | 10 |
| 80946MPP | 1/2"(F)x3/4"(M) | 48 | 140 | 10 |



1/2"DR. Adaptor (ball type)

| Part no. | Size | mm | g | pc/box |
|----------|-----------------|----|-----|--------|
| 80943MPB | 1/2"(F)x3/8"(M) | 38 | 72 | 10 |
| 80946MPB | 1/2"(F)x3/4"(M) | 48 | 145 | 10 |

NEW



1/2"DR. Bit holder

| Part no. | Size | mm | g | pc/box |
|----------|---------------------|----|----|--------|
| 81042MPB | 1/2"(F)x1/4"hex(F) | 50 | 76 | 10 |
| 81045MPB | 1/2"(F)x5/16"hex(F) | 50 | 89 | 10 |



O-ring & Pin for 1/2"DR.

| Part no. | mm | mm | g |
|----------|-----------|-----------|---|
| R1935 | Ø19- Ø3.5 | | 2 |
| P2030 | | 20L- Ø3.0 | 2 |
| R2435 | Ø24- Ø3.5 | | 2 |
| P2530 | | 25L- Ø3.0 | 2 |



1/2"DR. Impact ratchet wrench

| Part no. | mm | g | pc/box |
|----------|------------|------|--------|
| 82441 | 230mm-9.1" | 1200 | 1 |

Specifications :

Square Drive..... 1/2"
 Free Speed (R.P.M.)..... 160
 Max. Torque (Ft/Lbs) / (N-M)..... 74/ 100
 Air Pressure (PSI)..... 90
 AIR Inlet (P.T.)..... 1/4"
 Air Consumption (C.F.M.)..... 7
 * Rear exhaust



1/2"DR. Super duty impact ratchet wrench

| Part no. | mm | g | pc/box |
|----------|-------------|------|--------|
| 82442 | 260mm-10.3" | 1130 | 1 |

Specifications :

Square Drive..... 1/2"
 Free Speed (R.P.M.)..... 160
 Working Torque Range (Ft/Lbs) / (N-M)..... 10-55 / 14-75
 Max. Torque (Ft/Lbs) / (N-M)..... 60 / 81
 Air Pressure (PSI)..... 90
 AIR Inlet (P.T.)..... 1/4"
 Air Consumption (C.F.M.)..... 4

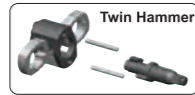

1/2"DR. Impact wrench

| | | | |
|--------------|------------|----------|---------------|
| 82541 | l | g | pc/box |
| Part no. | mm | g | pc/box |
| 82541 | 180mm-7.1" | 2560 | 1 |

Specifications :

Square Drive..... 1/2"
 Free Speed (R.P.M.)..... 8000
 Max. Torque (Ft/Lb) / (N.M)..... 400/542
 Air Pressure (PSI)..... 90
 AIR Inlet (P.T.)..... 1/4"
 Air Consumption (C.F.M.)..... 4.2
 * Front exhaust

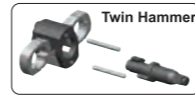

1/2"DR. Mini impact wrench

| | | | |
|--------------|------------|----------|---------------|
| 82543 | l | g | pc/box |
| Part no. | mm | g | pc/box |
| 82543 | 145mm-5.7" | 1500 | 1 |

Specifications :

Square Drive..... 1/2"
 Free Speed (R.P.M.)..... 12500
 Working Torque Range (Ft/Lbs) / (N-M)..... 90-280 / 120-378
 Max. Torque (Ft/Lbs) / (N-M)..... 300/400
 Air Pressure (PSI)..... 90
 AIR Inlet (P.T.)..... 1/4"
 Air Consumption (C.F.M.)..... 4



1/2"DR. Heavy duty composite impact wrench

| | | | |
|--------------|------------|----------|---------------|
| 82549 | l | g | pc/box |
| Part no. | mm | g | pc/box |
| 82549 | 171mm-6.7" | 1950 | 1 |

Specifications :

Square Drive..... 1/2"
 Free Speed (R.P.M.)..... 8000
 Working Torque Range (Ft/Lbs) / (N-M)..... 50-600 / 68-810
 Max. Torque (Ft/Lbs) / (N-M)..... 780/1054
 Air Pressure (PSI)..... 90
 AIR Inlet (P.T.)..... 1/4"
 Air Consumption (C.F.M.)..... 4

* Switch can be changed for right and left-handed.



5" Angle grinder with lever throttle

| | | | |
|--------------|------------|----------|---------------|
| 82601 | l | g | pc/box |
| Part no. | mm | g | pc/box |
| 82601 | 235mm-9.3" | 1800 | 1 |

Specifications :

Spindle Thread Size..... M10x1.5
 Free Speed (R.P.M.)..... 11000
 Air Pressure (PSI)..... 90
 AIR Inlet (P.T.)..... 1/4"
 Air Consumption (C.F.M.)..... 5



1/2"DR. Impact wrench

| | | | |
|--------------|------------|----------|---------------|
| 82542 | l | g | pc/box |
| Part no. | mm | g | pc/box |
| 82542 | 186mm-7.3" | 2560 | 1 |

Specifications :

Square Drive..... 1/2"
 Free Speed (R.P.M.)..... 8000
 Max. Torque (Ft/Lbs) / (N-M)..... 600/813
 Air Pressure (PSI)..... 90
 AIR Inlet (P.T.)..... 1/4"
 Air Consumption (C.F.M.)..... 4.2
 * Handle exhaust with muffler



1/2"DR. Mini composite impact wrench

| | | | |
|--------------|----------|----------|---------------|
| 82544 | l | g | pc/box |
| Part no. | mm | g | pc/box |
| 82544 | 154mm-6" | 1200 | 1 |

Specifications :

Square Drive..... 1/2"
 Free Speed (R.P.M.)..... 12500
 Working Torque Range (Ft/Lbs) / (N-M)..... 90-260 / 120-351
 Max. Torque (Ft/Lbs) / (N-M)..... 300/400
 Air Pressure (PSI)..... 90
 AIR Inlet (P.T.)..... 1/4"
 Air Consumption (C.F.M.)..... 4



1/2"Dr. Twin-hammer air impact wrench

| | | | |
|---------------|------------|----------|---------------|
| 825410 | l | g | pc/box |
| Part no. | mm | g | pc/box |
| 825410 | 185mm-7.3" | 2.63kg | 1 |

Specifications :

Working Torque Range 25-400 Ft/Lbs (34-544 NM)
 Max. Torque 600 Ft/Lb. (814 NM)
 Blow per Min. 1200
 Free speed 8500 RPM
 Recommend air pressure 90 PSI (6.35 kgs)
 Air Inlet 1/4" NPT (PT)
 Min. Hose Size 3/8" (10mm)
 Noise Level 102 dBA



6mm Industrial grader air die grinder

| | | | |
|--------------|------------|----------|---------------|
| 82602 | l | g | pc/box |
| Part no. | mm | g | pc/box |
| 82602 | 145mm-5.7" | 600 | 1 |

Specifications :

Collect Size..... 3mm; 6mm; 1/8"; 1/4"
 Free Speed (R.P.M.)..... 22000
 Air Pressure (PSI)..... 90
 AIR Inlet (P.T.)..... 1/4"
 Air Consumption (C.F.M.)..... 3

NEW



7pc 3/4" DR. 6pt. Impact socket set

| | | | |
|-------------|---|------------------|-----|
| 6071 | | | |
| Part no. | Socket | 4/24.0/25.0/1.1' | 6kg |
| 465 30...55 | Content: 3/4" DR. 7-6pt. Impact socket 30, 32, 36, 41, 46, 50, 55mm | | |



8pc 3/4" Impact socket set (MM)

| | | | |
|-------------|--|-------------------|-------|
| 6081 | | | |
| Part no. | Socket | 6/21.0/22.0/0.89' | 3500g |
| 465 26...38 | Content: 3/4"DR. 8-Impact socket 26; 27; 29; 30; 32; 35; 36; 38 mm | | |

8pc 3/4" Impact socket set (SAE)

| | | | |
|-----------------|---|-------------------|-------|
| 6081S | | | |
| Part no. | Socket | 6/21.0/22.0/0.89' | 3500g |
| 465 1.0...1.1.2 | Content: 3/4"DR. 8-Impact socket 1"; 1-1/16"; 1-1/8"; 1-1/4"; 1-5/16"; 1-3/8"; 1-7/16"; 1-1/2" | | |



8pc 3/4" Impact deep socket set (MM)

| | | | |
|----------------|---|------------------|-------|
| 6081D | | | |
| Part no. | Socket | 2/13.4/14.4/0.6' | 6700g |
| 465100 26...38 | Content: 3/4"DR. 8-Impact deep socket 26; 27; 29; 30; 32; 35; 36; 38 mm | | |

8pc 3/4" Impact deep socket set (SAE)

| | | | |
|----------------|--|------------------|-------|
| 6081DS | | | |
| Part no. | Socket | 2/13.4/14.4/0.6' | 6700g |
| 465100 26...38 | Content: 3/4"DR. 8-Impact deep socket 1"; 1-1/16"; 1-1/8"; 1-1/4"; 1-5/16"; 1-3/8"; 1-7/16"; 1-1/2" | | |



8pc 3/4" Impact deep socket set (MM)

| | | | |
|----------------|--|------------------|-------|
| 6082D | | | |
| Part no. | Socket | 2/13.4/14.4/0.6' | 6700g |
| 465100 27...41 | Content: 3/4"DR. 6-6pt. Flank impact deep socket 27; 30; 32; 35; 38; 41 mm | | |
| 46190 19...21 | 2-Square impact deep socket 19; 21 mm | | |

8pc 3/4" Impact deep socket set (SAE)

| | | | |
|-------------------|--|------------------|-------|
| 6082DS | | | |
| Part no. | Socket | 2/13.4/14.4/0.6' | 6700g |
| 465100 | Content: 3/4"DR. 6-6pt. Flank impact deep socket 1-1/16"; 1-1/8"; 1-3/16"; 1-1/4"; 1-3/8"; 1-1/2" | | |
| 1.1.16...1.1.2 | | | |
| 46190 3.4...13.16 | 2-Square impact deep socket 3/4"; 13/16" | | |



10pc 3/4" Impact wrench socket set

| | | | |
|-------------|--|------------------|-------|
| 6111 | | | |
| Part no. | Socket | 2/17.6/18.6/1.4' | 8.8kg |
| 465 22...41 | Content: 3/4"DR. 8-Impact socket 22; 24; 27; 30; 32; 36; 38; 41 mm | | |
| 82563 | 1-Impact wrench | | |
| 638M | 1-Mini oiler | | |



10pc 3/4" Impact wrench socket set

| | | | |
|----------------|---|------------------|------|
| 6111D | | | |
| Part no. | Socket | 2/17.6/18.6/1.4' | 11kg |
| 465100 22...41 | Content: 3/4"DR. 8-Impact deep socket 22; 24; 27; 30; 32; 36; 38; 41 mm | | |
| 82563 | 1-Impact wrench | | |
| 638M | 1-Mini oiler | | |



10pc 3/4" Impact wrench socket set

| | | | |
|---------------|--|------------------|-------|
| 6111-1 | | | |
| Part no. | Socket | 2/17.6/18.6/1.4' | 8.8kg |
| 465 22...41 | Content: 3/4"DR. 8-Impact socket 22; 24; 27; 30; 32; 36; 38; 41 mm | | |
| 82561 | 1-Impact wrench with grip | | |
| 638M | 1-Mini oiler | | |



10pc 3/4" Impact wrench socket set

| | | | |
|----------------|---|------------------|------|
| 6111D-1 | | | |
| Part no. | Socket | 2/17.6/18.6/1.4' | 11kg |
| 465100 22...41 | Content: 3/4"DR. 8-Impact deep socket 22; 24; 27; 30; 32; 36; 38; 41 mm | | |
| 82561 | 1-Impact wrench with grip | | |
| 638M | 1-Mini oiler | | |

NEW



11pc 3/4" DR. 6pt. Impact socket set

| 6112 | | | |
|-------------|---|------------------|-------|
| Part no. | Socket | 3/18.6/19.6/1.5' | 6.2kg |
| 465 17...50 | Content: 3/4" DR. 11-6pt. Impact socket 17, 19, 22, 24, 27, 30, 32, 36, 41, 46, 50mm | | |

NEW



11pc 3/4" DR. truck wheel impact socket

| 6113 | | | |
|----------------|---|------------------|-------|
| Part no. | Socket | 3/27.5/28/5/1.5' | 9150g |
| 46190 17...21 | Content: 3/4" DR. 2-Square impact deep socket 17;21mm | | |
| 46190 13.16 | 1-Square impact deep socket 13/16" | | |
| 465100 33...41 | 4-6pt. Flank impact deep socket 33;35;38;41mm | | |
| 465100 1.1.16 | 4-6pt. Flank impact deep socket 1-1/16; 1-1/8; 1-1/4' 1-1/2' | | |

NEW



14pc 3/4" DR. Impact wrench & socket set

| 6142 | | | |
|-------------|--|------------------|-------|
| Part no. | Socket | 3/26.3/27.3/1.5' | 8780g |
| 465 24...33 | Content: 3/4" DR. 5-6pt. Flank impact socket 24; 27; 30; 32; 33 mm | | |
| 82561 | 1-Impact wrench (with grip) | | |
| 8046175MPP | 1-Impact extension (pin type) 7" | | |
| 80561MPP | 1-Universal joint (pin type) | | |
| P3040 | 1-Pin 30L- Ø4.0 | | |
| P3540 | 1-Pin 35L- Ø 4.0 | | |
| P4540 | 1-Pin 45L- Ø 4.0 | | |
| R3355 | 1-Ring Ø 33- Ø 5.5 | | |
| R3755 | 1-Ring Ø 37- Ø 5.5 | | |
| R4455 | 1-Ring Ø 44- Ø 5.5 | | |

3/4" Hex impact socket bit (one-piece)

| 26490 | | | | |
|----------|--------|----|-----|--------|
| Part no. | Socket | mm | g | pc/box |
| 2649014 | 14 | 90 | 420 | 2 |
| 2649017 | 17 | 90 | 455 | 2 |
| 2649019 | 19 | 90 | 496 | 2 |
| 2649022 | 22 | 90 | 520 | 2 |
| 2649024 | 24 | 90 | 561 | 2 |
| 2649027 | 27 | 90 | 650 | 2 |
| 2649030 | 30 | 90 | 670 | 2 |
| 2649032 | 32 | 90 | 740 | 2 |



3/4" DR. Square impact socket

| 461 | | | | |
|------------------|--------|----|-----|--------|
| Part no. | Socket | mm | g | pc/box |
| 46117 | 17 | 50 | 398 | 1 |
| 46119 | 19 | 50 | 400 | 1 |
| 46120 NEW | 20 | 50 | 378 | 1 |
| 46121 | 21 | 50 | 412 | 1 |
| 46111.16 | 11/16" | 50 | 398 | 1 |
| 4613.4 | 3/4" | 50 | 400 | 1 |
| 46113.16 | 13/16" | 50 | 412 | 1 |



3/4" DR. Square impact deep socket

| 46190 | | | | |
|------------|--------|----|-----|--------|
| Part no. | Socket | mm | g | pc/box |
| 4619017 | 17 | 90 | 520 | 1 |
| 4619019 | 19 | 90 | 520 | 1 |
| 4619020 | 20 | 90 | 520 | 1 |
| 4619021 | 21 | 90 | 520 | 1 |
| 4619011.16 | 11/16" | 90 | 520 | 1 |
| 461903.4 | 3/4" | 90 | 520 | 1 |
| 4619013.16 | 13/16" | 90 | 520 | 1 |



3/4" DR. 6pt. Flank impact socket

| 465 | | | | |
|----------|--------|----|-----|--------|
| Part no. | Socket | mm | g | pc/box |
| 46517 | 17 | 50 | 254 | 1 |
| 46518 | 18 | 50 | 252 | 1 |
| 46519 | 19 | 50 | 248 | 1 |
| 46520 | 20 | 50 | 254 | 1 |
| 46521 | 21 | 50 | 254 | 1 |
| 46522 | 22 | 50 | 262 | 1 |
| 46523 | 23 | 50 | 266 | 1 |
| 46524 | 24 | 50 | 268 | 1 |
| 46525 | 25 | 50 | 268 | 1 |
| 46526 | 26 | 50 | 268 | 1 |

| 465 | | | | |
|---------------------|----------|----|------|--------|
| Part no. | Socket | mm | g | pc/box |
| 46527 | 27 | 54 | 294 | 1 |
| 46528 | 28 | 54 | 364 | 1 |
| 46529 | 29 | 54 | 362 | 1 |
| 46530 | 30 | 54 | 376 | 1 |
| 46531 | 31 | 54 | 384 | 1 |
| 46532 | 32 | 57 | 380 | 1 |
| 46533 | 33 | 57 | 412 | 1 |
| 46534 | 34 | 57 | 434 | 1 |
| 46535 | 35 | 57 | 438 | 1 |
| 46536 | 36 | 57 | 432 | 1 |
| 46537 | 37 | 57 | 444 | 1 |
| 46538 | 38 | 57 | 452 | 1 |
| 46539 | 39 | 57 | 478 | 1 |
| 46540 | 40 | 57 | 480 | 1 |
| 46541 | 41 | 57 | 498 | 1 |
| 46542 | 42 | 57 | 564 | 1 |
| 46543 | 43 | 63 | 580 | 1 |
| 46544 | 44 | 63 | 626 | 1 |
| 46545 | 45 | 63 | 658 | 1 |
| 46546 | 46 | 63 | 772 | 1 |
| 46547 NEW | 47 | 68 | 1078 | 1 |
| 46548 | 48 | 68 | 826 | 1 |
| 46550 | 50 | 68 | 880 | 1 |
| 46552 | 52 | 70 | 990 | 1 |
| 46554 | 54 | 70 | 1022 | 1 |
| 46555 | 55 | 72 | 1136 | 1 |
| 46557 | 57 | 72 | 1178 | 1 |
| 46558 | 58 | 75 | 1190 | 1 |
| 46559 NEW | 59 | 75 | 1489 | 1 |
| 46560 | 60 | 75 | 1282 | 1 |
| 46563 NEW | 63 | 78 | 1500 | 1 |
| 46565 | 65 | 78 | 1548 | 1 |
| 46570 NEW | 70 | 85 | 2038 | 1 |
| 4653.4 | 3/4" | 50 | 244 | 1 |
| 46511.16 NEW | 11/16" | 50 | 272 | 1 |
| 46513.16 | 13/16" | 50 | 258 | 1 |
| 4657.8 | 7/8" | 50 | 260 | 1 |
| 46515.16 | 15/16" | 50 | 264 | 1 |
| 4651.0 | 1" | 50 | 264 | 1 |
| 4651.1.16 | 1-1/16" | 54 | 300 | 1 |
| 4651.1.8 | 1-1/8" | 54 | 366 | 1 |
| 4651.3.16 | 1-3/16" | 54 | 366 | 1 |
| 4651.1.4 | 1-1/4" | 57 | 390 | 1 |
| 4651.5.16 | 1-5/16" | 57 | 418 | 1 |
| 4651.3.8 | 1-3/8" | 57 | 442 | 1 |
| 4651.7.16 | 1-7/16" | 57 | 464 | 1 |
| 4651.1.2 | 1-1/2" | 57 | 452 | 1 |
| 4651.9.16 | 1-9/16" | 57 | 524 | 1 |
| 4651.5.8 | 1-5/8" | 57 | 524 | 1 |
| 4651.11.16 | 1-11/16" | 63 | 582 | 1 |
| 4651.3.4 | 1-3/4" | 63 | 686 | 1 |
| 4651.13.16 | 1-13/16" | 63 | 748 | 1 |
| 4651.7.8 | 1-7/8" | 68 | 850 | 1 |
| 4651.15.16 | 1-15/16" | 68 | 910 | 1 |
| 4652.0 | 2" | 68 | 998 | 1 |
| 4652.1.16 | 2-1/16" | 70 | 990 | 1 |
| 4652.1.8 | 2-1/8" | 70 | 1022 | 1 |
| 4652.3.16 | 2-3/16" | 72 | 1062 | 1 |
| 4652.1.4 | 2-1/4" | 72 | 1176 | 1 |
| 4652.5.16 | 2-5/16" | 75 | 1190 | 1 |
| 4652.3.8 | 2-3/8" | 75 | 1282 | 1 |
| 4652.1.2 NEW | 2-1/2" | 78 | 1560 | 1 |
| 4652.5.8 NEW | 2-5/8" | 80 | 1715 | 1 |
| 4652.3.4 NEW | 2-3/4" | 85 | 2096 | 1 |



3/4" DR. 6pt. Flank impact middle deep socket

| 465 | | | | |
|------------|--------|----|-----|--------|
| Part no. | Socket | mm | g | pc/box |
| 4656021 | 21 | 60 | 228 | 1 |
| 4656022 | 22 | 60 | 228 | 1 |
| 4656023 | 23 | 60 | 227 | 1 |
| 4656024 | 24 | 60 | 226 | 1 |
| 4658526 | 26 | 85 | 384 | 1 |
| 4658527 | 27 | 85 | 392 | 1 |
| 4658530 | 30 | 85 | 456 | 1 |
| 4658532 | 32 | 85 | 450 | 1 |



3/4" DR. 6pt. Flank impact deep socket

| 465100 | | | | |
|---------------|--------|-----|-----|--------|
| Part no. | Socket | mm | g | pc/box |
| 46510017 | 17 | 100 | 352 | 1 |
| 46510018 | 18 | 100 | 368 | 1 |
| 46510019 | 19 | 100 | 426 | 1 |
| 46510020 | 20 | 100 | 434 | 1 |
| 46510021 | 21 | 100 | 456 | 1 |
| 46510022 | 22 | 100 | 496 | 1 |
| 46510023 | 23 | 100 | 514 | 1 |
| 46510024 | 24 | 100 | 704 | 1 |
| 46510025 | 25 | 100 | 476 | 1 |
| 46510026 | 26 | 100 | 480 | 1 |
| 46510027 | 27 | 100 | 506 | 1 |
| 46510028 | 28 | 100 | 568 | 1 |
| 46510029 | 29 | 100 | 576 | 1 |
| 46510030 | 30 | 100 | 626 | 1 |
| 46510032 | 32 | 100 | 598 | 1 |
| 46510033 | 33 | 100 | 650 | 1 |
| 46510034 | 34 | 100 | 710 | 1 |
| 46510035 | 35 | 100 | 728 | 1 |
| 46510036 | 36 | 100 | 726 | 1 |
| 46510037 | 37 | 100 | 748 | 1 |
| 46510038 | 38 | 100 | 700 | 1 |
| 46510039 | 39 | 100 | 828 | 1 |
| 46510040 | 40 | 100 | 848 | 1 |

| 465100 | | | | |
|---------------|----------|-----|------|--------|
| Part no. | Socket | mm | g | pc/box |
| 46510041 | 41 | 100 | 866 | 1 |
| 46510042 | 42 | 100 | 936 | 1 |
| 46510043 | 43 | 100 | 1133 | 1 |
| 46510044 | 44 | 100 | 1151 | 1 |
| 46510045 | 45 | 100 | 1237 | 1 |
| 46510046 | 46 | 100 | 1176 | 1 |
| 46510047 | 47 | 100 | 1390 | 1 |
| 46510048 | 48 | 100 | 1282 | 1 |
| 46510050 | 50 | 100 | 1312 | 1 |
| 46510055 | 55 | 100 | 1358 | 1 |
| 46510060 | 60 | 100 | 1734 | 1 |
| 46510065 | 65 | 100 | 1710 | 1 |
| 46510011.16 | 11/16" | 100 | 387 | 1 |
| 4651003.4 | 3/4" | 100 | 434 | 1 |
| 46510013.16 | 13/16" | 100 | 456 | 1 |
| 4651007.8 | 7/8" | 100 | 496 | 1 |
| 46510015.16 | 15/16" | 100 | 512 | 1 |
| 4651001.0 | 1" | 100 | 480 | 1 |
| 4651001.1.16 | 1-1/16" | 100 | 506 | 1 |
| 4651001.1.8 | 1-1/8" | 100 | 568 | 1 |
| 4651001.3.16 | 1-3/16" | 100 | 626 | 1 |
| 4651001.1.4 | 1-1/4" | 100 | 598 | 1 |
| 4651001.5.16 | 1-5/16" | 100 | 638 | 1 |
| 4651001.3.8 | 1-3/8" | 100 | 714 | 1 |
| 4651001.7.16 | 1-7/16" | 100 | 770 | 1 |
| 4651001.1.2 | 1-1/2" | 100 | 848 | 1 |
| 4651001.9.16 | 1-9/16" | 100 | 856 | 1 |
| 4651001.5.8 | 1-5/8" | 100 | 852 | 1 |
| 4651001.11.16 | 1-11/16" | 100 | 1028 | 1 |
| 4651001.3.4 | 1-3/4" | 100 | 1190 | 1 |
| 4651001.13.16 | 1-13/16" | 100 | 1148 | 1 |
| 4651001.7.8 | 1-7/8" | 100 | 1316 | 1 |
| 4651002.0 | 2" | 100 | 1430 | 1 |
| 4651001.15.16 | 1-15/16" | 100 | 1416 | 1 |



3/4" DR. Star impact deep socket

| 466110 | | | | |
|---------------|--------|-----|-----|--------|
| Part no. | Socket | mm | g | pc/box |
| 46611018 | E18 | 110 | 520 | 1 |
| 46611020 | E20 | 110 | 540 | 1 |
| 46611024 | E24 | 110 | 591 | 1 |



3/4" DR. 12pt impact socket

| 468 | | | | |
|------------|--------|----|------|--------|
| Part no. | Socket | mm | g | pc/box |
| 46817 | 17 | 50 | 248 | 1 |
| 46818 | 18 | 50 | 219 | 1 |
| 46819 | 19 | 50 | 252 | 1 |
| 46820 | 20 | 50 | 230 | 1 |
| 46821 | 21 | 50 | 232 | 1 |
| 46822 | 22 | 50 | 350 | 1 |
| 46823 | 23 | 50 | 360 | 1 |
| 46824 | 24 | 50 | 360 | 1 |
| 46826 | 26 | 50 | 336 | 1 |
| 46827 | 27 | 54 | 323 | 1 |
| 46828 | 28 | 54 | 356 | 1 |
| 46829 | 29 | 54 | 354 | 1 |
| 46830 | 30 | 54 | 360 | 1 |
| 46831 | 31 | 54 | 370 | 1 |
| 46832 | 32 | 57 | 370 | 1 |
| 46833 | 33 | 57 | 400 | 1 |
| 46834 | 34 | 57 | 418 | 1 |
| 46835 | 35 | 57 | 400 | 1 |
| 46836 | 36 | 57 | 420 | 1 |
| 46837 | 37 | 57 | 444 | 1 |
| 46838 | 38 | 57 | 454 | 1 |
| 46839 | 39 | 57 | 478 | 1 |
| 46841 | 41 | 57 | 608 | 1 |
| 46846 | 46 | 63 | 740 | 1 |
| 46850 | 50 | 68 | 1068 | 1 |



3/4" DR. Impact extension (Pin type)

| 8046..MPP | | | |
|------------------|---------|------|--------|
| Part no. | mm | g | pc/box |
| 8046100MPP | 100-4" | 641 | 2 |
| 8046175MPP | 175-7" | 923 | 2 |
| 8046250MPP | 250-10" | 1223 | 2 |
| 8046330MPP | 330-13" | 1544 | 1 |

3/4" DR. Impact extension (Ball type)

| 8046..MPB | | | |
|------------------|---------|------|--------|
| Part no. | mm | g | pc/box |
| 8046100MPB | 100-4" | 325 | 2 |
| 8046150MPB | 150-6" | 797 | 2 |
| 8046175MPB | 175-7" | 927 | 2 |
| 8046200MPB | 200-8" | 993 | 2 |
| 8046250MPB | 250-10" | 1224 | 2 |
| 8046330MPB | 330-13" | 1546 | 1 |



3/4" DR. Universal joint (pin type)

| 80561MPP | | | |
|-----------------|-----|-----|--------|
| Part no. | mm | g | pc/box |
| 80561MPP | 110 | 602 | 1 |



3/4" DR. Universal joint (ball type)

| 80561MPB | | | |
|-----------------|-----|-----|--------|
| Part no. | mm | g | pc/box |
| 80561MPB | 110 | 624 | 1 |



3/4" DR. Adaptor (pin type)

| 8096..MPP | | | | |
|------------------|-----------------|----|-----|--------|
| Part no. | size | mm | g | pc/box |
| 80964MPP | 3/4"(F)x1/2"(M) | 58 | 334 | 2 |
| 80968MPP | 3/4"(F)x1"(M) | 63 | 430 | 2 |



3/4" DR. Adaptor (ball type)

| 8096..MPB | | | | |
|------------------|-----------------|----|-----|--------|
| Part no. | size | mm | g | pc/box |
| 80964MPB | 3/4"(F)x1/2"(M) | 58 | 320 | 2 |
| 80968MPB | 3/4"(F)x1"(M) | 63 | 400 | 2 |



O-ring & Pin for 3/4" DR.

| Part no. | mm | mm | g |
|-------------|-----------|-----------|---|
| R3355 P3040 | ø33- ø5.5 | 30L- ø4.0 | 3 |
| R3755 P3540 | ø37- ø5.5 | 35L- ø4.0 | 3 |
| R4455 P4540 | ø44- ø5.5 | 45L- ø4.0 | 3 |

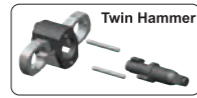

3/4"DR. Impact wrench (with grip)

| 82561 | | | |
|--------------|------------|------|--------|
| Part no. | mm | g | pc/box |
| 82561 | 217mm-8.5" | 4100 | 1 |

Specifications :

| | |
|--|--------------------|
| Square Drive..... | 3/4" |
| Free Speed (R.P.M.)..... | 7250 |
| Working Torque Range (Ft/Lbs) / (N-M)..... | 200-800 / 271-1084 |
| Max. Torque (Ft/Lbs) / (N-M)..... | 1100 / 1491 |
| Air Pressure (PSI)..... | 90 |
| AIR Inlet (P.T.)..... | 1/4" |
| Air Consumption (C.F.M.)..... | 7.5 |



3/4"DR. Impact wrench

| 82563 | | | |
|--------------|------------|------|--------|
| Part no. | mm | g | pc/box |
| 82563 | 234mm-9.2" | 4550 | 1 |

Specifications :

| | |
|-----------------------------------|------------|
| Square Drive..... | 3/4" |
| Free Speed (R.P.M.)..... | 6500 |
| Max. Torque (Ft/Lbs) / (N-M)..... | 750 / 1016 |
| Air Pressure (PSI)..... | 90 |
| AIR Inlet (P.T.)..... | 1/4" |
| Air Consumption (C.F.M.)..... | 7 |
| * Handle exhaust with muffler | |



8pc 1" Impact socket set (MM)

| 8081 | | | |
|-------------|---|------------------|-------|
| Part no. | Socket | 4/24.6/25.6/0.8' | 6150g |
| 485 24...41 | Content: 1"DR. 8-Impact socket 24; 27; 30; 32; 33; 36; 38; 41 mm | | |

8pc 1" Impact socket set (SAE)

| 8081S | | | |
|-------------------|---|------------------|-------|
| Part no. | Socket | 4/24.6/25.6/0.8' | 6150g |
| 485 15.16...1.5.8 | Content: 1"DR. 8-Impact socket 15/16"; 1-1/16"; 1-3/16"; 1-1/4"; 1-5/16"; 1-7/16"; 1-1/2"; 1-5/8" | | |



8pc 1" Impact socket set (MM)

| 8082 | | | |
|----------------------------|---|------------------|-------|
| Part no. | Socket | 4/24.6/25.6/0.8' | 6150g |
| 485 27...41 481 17...21 | Content: 1"DR. 5-6pt. Flank impact socket 27; 32; 35; 38; 41 mm 3-Square impact socket 17; 19; 21 mm | | |

8pc 1" Impact socket set (SAE)

| 8082S | | | |
|---------------------------------------|--|------------------|-------|
| Part no. | Socket | 4/24.6/25.6/0.8' | 6150g |
| 481 1.1.16...1.1.2 481 3.4...13.16 | Content: 1"DR. 6-6pt. Flank impact socket 1-1/16"; 1-1/8"; 1-3/16"; 1-1/4"; 1-3/8"; 1-1/2" 2-Square impact socket 3/4"; 13/16" | | |



3/4" DR. Light Duty Impact wrench

| 82562 | | | |
|--------------|----------|------|--------|
| Part no. | mm | g | pc/box |
| 82562 | 180mm-7" | 2700 | 1 |

Specifications :

| | |
|--|-----------------|
| Free Speed (R.P.M.)..... | 9000 |
| Max. Torque (Ft/Lbs) / (N-M)..... | 780 / 1054 |
| Working Torque Range (Ft/Lbs) / (N-M)..... | 50-600 / 68-810 |
| Air Pressure (PSI)..... | 90 |
| AIR Inlet (P.T.)..... | 1/4" |

NEW



7pc 1" DR. 6pt. Impact socket set

| 8071 | | | |
|-------------|--|------------------|------|
| Part no. | Socket | 2/28.0/29.0/1.1' | 14kg |
| 485 46...75 | Content: 1" DR. 7-6pt. Impact socket 46, 50, 55, 60, 65, 70, 75mm | | |



8pc 1" Impact socket set (MM)

| 8081D | | | |
|----------------|---|------------------|-------|
| Part no. | Socket | 2/18.4/19.4/0.6' | 9200g |
| 485100 24...41 | Content: 1"DR. 8-Impact socket 24; 27; 30; 32; 33; 36; 38; 41 mm | | |

8pc 1" Impact socket set (SAE)

| 8081DS | | | |
|-------------------------|--|------------------|-------|
| Part no. | Socket | 2/18.4/19.4/0.6' | 9200g |
| 485100 15.16...1.5.8 | Content: 1"DR. 8-Impact deep socket 15/16"; 1-1/16"; 1-3/16"; 1-1/4"; 1-5/16"; 1-7/16"; 1-1/2"; 1-5/8" | | |



8pc 1" Impact deep socket set (MM)

| 8082D | | | |
|---------------------------------|---|------------------|-------|
| Part no. | Socket | 2/18.4/19.4/0.6' | 9200g |
| 485100 27...41 48190 17...21 | Content: 1"DR. 5-6pt. Flank impact deep socket 27; 32; 35; 38; 41 mm 3-Square impact deep socket 17; 19; 21 mm | | |

8pc 1" Impact deep socket set (SAE)

| 8082DS | | | |
|---|--|------------------|-------|
| Part no. | Socket | 2/18.4/19.4/0.6' | 9200g |
| 481100 1.1.16...1.1.2 48190 3.4...13.16 | Content: 1"DR. 6-6pt. Flank impact deep socket 1-1/16"; 1-1/8"; 1-3/16"; 1-1/4"; 1-3/8"; 1-1/2" 2-Square impact deep socket 3/4"; 13/16" | | |

NEW



8pc 1" DR. 6pt. Impact socket set

| 8083 | | | |
|-------------|---|------------------|-----|
| Part no. | Socket | 2/14.0/15.0/0.8' | 7kg |
| 485 22...46 | Content: 1" DR. 8-6pt. Impact socket 22, 24, 27, 30, 32, 36, 41, 46mm | | |



10pc 1" Impact wrench socket set

| 8091-1 | | | |
|-------------|--|------------------|--------|
| Part no. | Socket | 1/20.8/21.8/2.5' | 20.8kg |
| 485 27...41 | Content: 1"DR. 8-Impact socket 27; 30; 32; 33; 35; 36; 38; 41 mm | | |
| 82581 | 1-Impact wrench with 9" extension | | |
| 638M | 1-Mini oiler | | |



10pc 1" Impact wrench socket set

| 8091D | | | |
|----------------|---|------------------|--------|
| Part no. | Socket | 1/21.7/22.7/2.5' | 21.7kg |
| 485100 27...41 | Content: 1"DR. 8-Impact deep socket 27; 30; 32; 33; 35; 36; 38; 41 mm | | |
| 82585 | 1-Impact wrench | | |
| 638M | 1-Mini oiler | | |



1"DR. Square impact socket

| 481 | | <i>l</i> | | |
|----------|--------|----------|-----|--------|
| Part no. | Socket | mm | g | pc/box |
| 48117 | 17 | 60 | 570 | 1 |
| 48119 | 19 | 60 | 580 | 1 |
| 48121 | 21 | 60 | 590 | 1 |
| 48111.16 | 11/16" | 60 | 565 | 1 |
| 4813.4 | 3/4" | 60 | 580 | 1 |
| 48113.16 | 13/16" | 60 | 585 | 1 |

1"DR. Square impact deep socket

| 48190 | | <i>l</i> | | |
|------------|--------|----------|-----|--------|
| Part no. | Socket | mm | g | pc/box |
| 4819017 | 17 | 90 | 780 | 1 |
| 4819019 | 19 | 90 | 850 | 1 |
| 4819021 | 21 | 90 | 990 | 1 |
| 4819011.16 | 11/16" | 90 | 770 | 1 |
| 481903.4 | 3/4" | 90 | 850 | 1 |
| 4819013.16 | 13/16" | 90 | 980 | 1 |



10pc 1" Impact wrench socket set

| 8091 | | | |
|-------------|--|------------------|--------|
| Part no. | Socket | 1/20.8/21.8/2.5' | 20.8kg |
| 485 27...41 | Content: 1"DR. 8-Impact socket 27; 30; 32; 33; 35; 36; 38; 41 mm | | |
| 82585 | 1-Impact wrench | | |
| 638M | 1-Mini oiler | | |



10pc 1" Impact wrench socket set

| 8091MD | | | |
|---------------|--|------------------|------|
| Part no. | Socket | 1/21.0/22.0/2.5' | 21kg |
| 48580 27...41 | Content: 1"DR. 8-Impact middle deep socket 27; 30; 32; 33; 35; 36; 38; 41 mm | | |
| 82585 | 1-Impact wrench | | |
| 638M | 1-Mini oiler | | |



10pc 1" Impact wrench socket set

| 8091D-1 | | | |
|----------------|---|------------------|--------|
| Part no. | Socket | 1/21.7/22.7/2.5' | 21.7kg |
| 485100 27...41 | Content: 1"DR. 8-Impact deep socket 27; 30; 32; 33; 35; 36; 38; 41 mm | | |
| 82581 | 1-Impact wrench with 9" extension | | |
| 638M | 1-Mini oiler | | |







1"DR. Truck nut impact socket

| 482 | | | <i>l</i> | | |
|----------|--------|--------|----------|-----|--------|
| Part no. | Socket | middle | mm | g | pc/box |
| 48217 | | 17 | 76 | 684 | 1 |
| 482175 | | 17.5 | 76 | 684 | 1 |
| 48219 | | 19 | 76 | 712 | 1 |
| 48220 | | 20 | 76 | 712 | 1 |
| 482205 | | 20.5 | 76 | 712 | 1 |
| 48221 | | 21 | 76 | 694 | 1 |
| 482215 | | 21.5 | 76 | 693 | 1 |
| 48222 | | 22 | 76 | 692 | 1 |
| 48211.16 | | 11/16" | 76 | 684 | 1 |
| 4823.4 | | 3/4" | 76 | 712 | 1 |
| 48213.16 | | 13/16" | 76 | 694 | 1 |
| 4827.8 | | 7/8" | 76 | 694 | 1 |









1"DR. Rear wheel nut socket

| 484 | |  |  | <i>l</i> |  |  |
|----------|--------|---|---|----------|---|---|
| Part no. | Socket | middle | mm | g | pc/box | |
| 4843517 | 35 | 17 | 100 | 1168 | 1 | |
| 4843820 | 38 | 20 | 100 | 1260 | 1 | |
| 4844121 | 41 | 21 | 100 | 1326 | 1 | |
| 4843820S | 1-1/2" | 13/16" | 100 | 1260 | 1 | |





1"DR. 6pt. Flank impact socket

| 485 | |  | <i>l</i> |  |  |
|----------------------|--------|---|----------|---|---|
| Part no. | Socket | mm | g | pc/box | |
| 48517 ^{NEW} | 17 | 58 | 566 | 1 | |
| 48519 | 19 | 58 | 640 | 1 | |
| 48520 | 20 | 58 | 630 | 1 | |
| 48521 | 21 | 58 | 628 | 1 | |
| 48522 | 22 | 58 | 628 | 1 | |
| 48523 | 23 | 58 | 644 | 1 | |
| 48524 | 24 | 58 | 644 | 1 | |
| 48525 | 25 | 58 | 636 | 1 | |
| 48526 | 26 | 58 | 634 | 1 | |
| 48527 | 27 | 58 | 632 | 1 | |
| 48528 | 28 | 58 | 642 | 1 | |
| 48529 | 29 | 58 | 660 | 1 | |
| 48530 | 30 | 60 | 656 | 1 | |
| 48532 | 32 | 60 | 664 | 1 | |
| 48533 | 33 | 60 | 664 | 1 | |
| 48534 | 34 | 62 | 694 | 1 | |
| 48535 | 35 | 62 | 674 | 1 | |
| 48536 | 36 | 65 | 684 | 1 | |
| 48537 | 37 | 65 | 658 | 1 | |
| 48538 | 38 | 65 | 674 | 1 | |
| 48539 ^{NEW} | 39 | 65 | 748 | 1 | |
| 48540 ^{NEW} | 40 | 67 | 785 | 1 | |
| 48541 | 41 | 67 | 760 | 1 | |
| 48542 | 42 | 70 | 760 | 1 | |
| 48543 | 43 | 75 | 844 | 1 | |
| 48544 | 44 | 75 | 928 | 1 | |
| 48545 | 45 | 75 | 990 | 1 | |
| 48546 | 46 | 75 | 1124 | 1 | |

| 485 |  | <i>l</i> |  |  |
|----------------------|---|----------|---|---|
| Part no. | Socket | mm | g | pc/box |
| 48547 | 47 | 75 | 1015 | 1 |
| 48548 | 48 | 75 | 1065 | 1 |
| 48550 | 50 | 75 | 1081 | 1 |
| 48552 | 52 | 75 | 1096 | 1 |
| 48554 | 54 | 80 | 1242 | 1 |
| 48555 | 55 | 80 | 1238 | 1 |
| 48557 ^{NEW} | 57 | 80 | 1500 | 1 |
| 48558 | 58 | 85 | 1422 | 1 |
| 48560 | 60 | 85 | 1748 | 1 |
| 48563 | 63 | 85 | 1864 | 1 |
| 48565 | 65 | 85 | 1642 | 1 |
| 48567 | 67 | 90 | 1642 | 1 |
| 48570 | 70 | 90 | 1690 | 1 |
| 48571 | 71 | 95 | 2620 | 1 |
| 48572 | 72 | 95 | 2820 | 1 |
| 48575 | 75 | 95 | 2532 | 1 |
| 48577 | 77 | 100 | 2598 | 1 |
| 48580 | 80 | 100 | 2774 | 1 |
| 48585 | 85 | 105 | 4330 | 1 |
| 48590 | 90 | 105 | 3412 | 1 |
| 48595 | 95 | 105 | 4400 | 1 |
| 4853.4 | 3/4" | 58 | 665 | 1 |
| 48513.16 | 13/16" | 58 | 665 | 1 |
| 4857.8 | 7/8" | 58 | 660 | 1 |
| 48515.16 | 15/16" | 58 | 660 | 1 |
| 4851.0 | 1" | 58 | 650 | 1 |
| 4851.1.16 | 1-1/16 | 58 | 655 | 1 |
| 4851.1.8 | 1-1/8" | 58 | 655 | 1 |
| 4851.3.16 | 1-3/16" | 60 | 670 | 1 |
| 4851.1.4 | 1-1/4" | 60 | 670 | 1 |
| 4851.5.16 | 1-5/16" | 62 | 675 | 1 |
| 4851.3.8 | 1-3/8" | 62 | 675 | 1 |
| 4851.7.16 | 1-7/16" | 65 | 695 | 1 |
| 4851.1.2 | 1-1/2" | 65 | 720 | 1 |
| 4851.9.16 | 1-9/16" | 65 | 765 | 1 |
| 4851.5.8 | 1-5/8" | 70 | 815 | 1 |
| 4851.11.16 | 1-11/16" | 70 | 865 | 1 |
| 4851.3.4 | 1-3/4" | 75 | 910 | 1 |
| 4851.13.16 | 1-13/16" | 75 | 1015 | 1 |
| 4851.7.8 | 1-7/8" | 75 | 1065 | 1 |
| 4851.15.16 | 1-15/16" | 75 | 1085 | 1 |
| 4852.0 | 2" | 75 | 1250 | 1 |
| 4852.1.16 | 2-1/16" | 75 | 1370 | 1 |
| 4852.1.8 | 2-1/8" | 80 | 1405 | 1 |
| 4852.3.16 | 2-3/16" | 80 | 1565 | 1 |
| 4852.1.4 | 2-1/4" | 85 | 1605 | 1 |
| 4852.5.16 | 2-5/16" | 85 | 1675 | 1 |
| 4852.3.8 | 2-3/8" | 85 | 1875 | 1 |
| 4852.7.16 | 2-7/16" | 85 | 1980 | 1 |
| 4852.1.2 | 2-1/2" | 85 | 2055 | 1 |
| 4852.9.16 | 2-9/16" | 85 | 2170 | 1 |
| 4852.5.8 | 2-5/8" | 90 | 2295 | 1 |
| 4852.11.16 | 2-11/16" | 90 | 2425 | 1 |
| 4852.3.4 | 2-3/4" | 90 | 2510 | 1 |
| 4852.13.16 | 2-13/16" | 95 | 2745 | 1 |
| 4852.7.8 | 2-7/8" | 95 | 2910 | 1 |
| 4852.15.16 | 2-15/16" | 95 | 3590 | 1 |
| 4853.0 | 3" | 100 | 3715 | 1 |
| 4853.1.16 | 3-1/16" | 100 | 3840 | 1 |
| 4853.1.8 | 3-1/8" | 100 | 3960 | 1 |
| 4853.1.4 | 3-1/4" | 105 | 4185 | 1 |
| 4853.3.8 | 3-3/8" | 105 | 4285 | 1 |
| 4853.1.2 | 3-1/2" | 105 | 4485 | 1 |





1"DR. 6pt. Flank impact middle deep socket

| 48580 | |  | <i>l</i> |  |  |
|----------|--------|---|----------|---|---|
| Part no. | Socket | mm | g | pc/box | |
| 4858027 | 27 | 80 | 608 | 1 | |
| 4858030 | 30 | 80 | 652 | 1 | |
| 4858032 | 32 | 80 | 766 | 1 | |
| 4858033 | 33 | 80 | 802 | 1 | |
| 4858035 | 35 | 80 | 798 | 1 | |
| 4858036 | 36 | 80 | 808 | 1 | |
| 4858038 | 38 | 80 | 826 | 1 | |
| 4858041 | 41 | 80 | 818 | 1 | |



1"DR. 6pt. Flank impact deep socket



| 485100 | |  | <i>l</i> |  |  |
|-------------------------|--------|---|----------|---|---|
| Part no. | Socket | mm | g | pc/box | |
| 48510024 | 24 | 100 | 932 | 1 | |
| 48510025 ^{NEW} | 25 | 100 | 879 | 1 | |
| 48510026 | 26 | 100 | 932 | 1 | |
| 48510027 | 27 | 100 | 952 | 1 | |
| 48510028 ^{NEW} | 28 | 100 | 1000 | 1 | |
| 48510029 | 29 | 100 | 994 | 1 | |
| 48510030 | 30 | 100 | 1010 | 1 | |
| 48510032 | 32 | 100 | 1096 | 1 | |
| 48510033 | 33 | 100 | 1012 | 1 | |
| 48510034 | 34 | 100 | 1044 | 1 | |
| 48510035 | 35 | 100 | 1052 | 1 | |
| 48510036 | 36 | 100 | 1148 | 1 | |
| 48510037 ^{NEW} | 37 | 100 | 1153 | 1 | |
| 48510038 | 38 | 100 | 1044 | 1 | |
| 48510041 | 41 | 100 | 1158 | 1 | |
| 48510042 ^{NEW} | 42 | 100 | 1294 | 1 | |
| 48510045 ^{NEW} | 45 | 100 | 1377 | 1 | |
| 48510046 | 46 | 100 | 1314 | 1 | |
| 48510048 | 48 | 100 | 1362 | 1 | |
| 48510050 | 50 | 100 | 1402 | 1 | |
| 48510054 | 54 | 100 | 1570 | 1 | |
| 48510055 | 55 | 100 | 1696 | 1 | |
| 48510058 | 58 | 100 | 1856 | 1 | |
| 48510060 | 60 | 100 | 1978 | 1 | |
| 48512063 | 63 | 120 | 2120 | 1 | |

485100

| Part no. | Socket | mm | g | pc/box |
|-----------------------------|----------|-----|------|--------|
| 48512065 | 65 | 120 | 2430 | 1 |
| 48512067 | 67 | 120 | 2550 | 1 |
| 48513570 | 70 | 135 | 2690 | 1 |
| 48513572 ^{NEW} | 72 | 135 | 2900 | 1 |
| 48513575 | 75 | 135 | 4359 | 1 |
| 48513577 | 77 | 135 | 4104 | 1 |
| 48510015.16 | 15/16" | 100 | 885 | 1 |
| 4851001.0 | 1" | 100 | 975 | 1 |
| 4851001.1.16 | 1-1/16" | 100 | 1055 | 1 |
| 4851001.1.8 | 1-1/8" | 100 | 1075 | 1 |
| 4851001.3.16 | 1-3/16" | 100 | 1130 | 1 |
| 4851001.1.4 | 1-1/4" | 100 | 1115 | 1 |
| 4851001.5.16 | 1-5/16" | 100 | 1120 | 1 |
| 4851001.3.8 | 1-3/8" | 100 | 1125 | 1 |
| 4851001.7.16 | 1-7/16" | 100 | 1165 | 1 |
| 4851001.1.2 | 1-1/2" | 100 | 1120 | 1 |
| 4851001.9.16 | 1-9/16" | 100 | 1265 | 1 |
| 4851001.5.8 | 1-5/8" | 100 | 1285 | 1 |
| 4851001.11.16 | 1-11/16" | 100 | 1410 | 1 |
| 4851001.3.4 | 1-3/4" | 100 | 1485 | 1 |
| 4851001.13.16 | 1-13/16" | 100 | 1500 | 1 |
| 4851001.7.8 | 1-7/8" | 100 | 1550 | 1 |
| 4851001.15.16 | 1-15/16" | 100 | 1560 | 1 |
| 4851002.0 | 2" | 100 | 1650 | 1 |
| 4851002.1.16 | 2-1/16" | 100 | 1730 | 1 |
| 4851002.1.8 | 2-1/8" | 100 | 1750 | 1 |
| 4851002.3.16 | 2-3/16" | 100 | 1900 | 1 |
| 4851002.1.4 | 2-1/4" | 100 | 1980 | 1 |
| 4851002.5.16 | 2-5/16" | 100 | 2100 | 1 |
| 4851002.3.8 | 2-3/8" | 100 | 2450 | 1 |
| 4851202.7.16 ^{NEW} | 2-7/16" | 120 | 2580 | 1 |
| 4851202.1.2 ^{NEW} | 2-1/2" | 120 | 2465 | 1 |



1"DR. 12pt. Impact socket

| 488 | |  | <i>l</i> |  |  |
|----------|--------|---|----------|---|---|
| Part no. | Socket | mm | g | pc/box | |
| 48850 | 50 | 75 | 1300 | 1 | |
| 48855 | 55 | 80 | 1500 | 1 | |
| 48865 | 65 | 85 | 1655 | 1 | |



1"DR. Impact extension (pin type)

| Part no. | mm | g | pc/box |
|------------------|----------|------|--------|
| 8048..MPP | <i>l</i> | | |
| 8048100MPP | 100-4" | 935 | 2 |
| 8048175MPP | 175-7" | 1476 | 2 |
| 8048250MPP | 250-10" | 1961 | 2 |
| 8048330MPP | 330-13" | 2702 | 1 |

1"DR. Impact extension (ball type)

| Part no. | mm | g | pc/box |
|------------------|----------|------|--------|
| 8048..MPB | <i>l</i> | | |
| 8048100MPB | 100-4" | 935 | 2 |
| 8048175MPB | 175-7" | 1476 | 2 |
| 8048250MPB | 250-10" | 2050 | 2 |
| 8048330MPB | 330-13" | 2578 | 1 |



1"DR. Universal joint (pin type)

| Part no. | mm | g | pc/box |
|-----------------|----------|------|--------|
| 80581MPP | <i>l</i> | | |
| 80581MPP | 135 | 1626 | 1 |



1"DR. Universal joint (ball type)

| Part no. | mm | g | pc/box |
|-----------------|----------|------|--------|
| 80581MPB | <i>l</i> | | |
| 80581MPB | 135 | 1626 | 1 |



1"DR. Adaptor (pin type)

| Part no. | Size | mm | g | pc/box |
|------------------|-----------------|----|------|--------|
| 8098..MPP | <i>l</i> | | | |
| 80986MPP | 1"(F)x3/4"(M) | 75 | 1070 | 1 |
| 809812MPP | 1"(F)x1-1/2"(M) | 80 | 1506 | 1 |



1"DR. Adaptor (ball type)

| Part no. | Size | mm | g | pc/box |
|------------------|---------------|----|-----|--------|
| 8098..MPB | <i>l</i> | | | |
| 80986MPB | 1"(F)x3/4"(M) | 75 | 596 | 2 |



O-ring & Pin for 1"DR.

| Part no. | mm | mm | g |
|----------|-----------|-----------|---|
| R4455 | Ø44- Ø5.5 | | 4 |
| P4550 | | 45L- Ø5.0 | 4 |
| R7555 | Ø75- Ø5.5 | | 4 |
| P7550 | | 75L- Ø5.0 | 4 |

Pinless



1" Impact wrench with 9" extension

| Part no. | mm | kg | pc/box |
|--------------|-----------|------|--------|
| 82581 | <i>l</i> | | |
| 82581 | 579mm-23" | 13.0 | 1 |

Specifications :
 Square Drive..... 1"
 Free Speed (R.P.M.).....5000
 Max. Torque (Ft/Lbs) / (N-M).... 2000/2720
 Air Pressure (PSI).....90
 AIR Inlet (P.T.)..... 1/2"
 Air Consumption (C.F.M.)..... 10

1" Impact wrench

| Part no. | mm | kg | pc/box |
|-------------------|-----------|------|--------|
| 82581S NEW | <i>l</i> | | |
| 82581S | 350mm-14" | 11.0 | 1 |

Specifications :
 Square Drive..... 1"
 Free Speed (R.P.M.)..... 5000
 Max. Torque (Ft/Lbs) / (N-M).... 2000/2720
 Air Pressure (PSI)..... 90
 AIR Inlet (P.T.)..... 1/2"
 Air Consumption (C.F.M.)..... 10

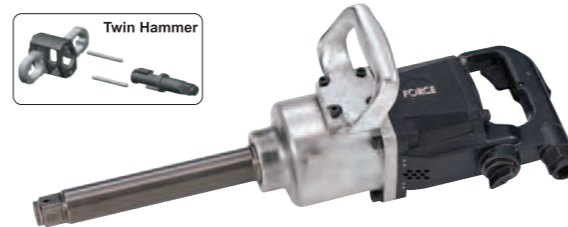

1"DR. Impact wrench with 6"anvil

| Part no. | mm | kg | pc/box |
|--------------|-----------|------|--------|
| 82585 | <i>l</i> | | |
| 82585 | 518mm-20" | 12.5 | 1 |

Specifications :
 Square Drive..... 1"
 Free Speed (R.P.M.)..... 4000
 Max. Torque (Ft/Lbs) / (N-M).... 1800 /2439
 Air Pressure (PSI)..... 90
 AIR Inlet (P.T.)..... 1/2"
 Air Consumption (C.F.M.)..... 12

* Side exhaust

1"DR. Impact wrench

| Part no. | mm | kg | pc/box |
|-------------------|-------------|----|--------|
| 82585S NEW | <i>l</i> | | |
| 82585S | 365mm-14.5" | 10 | 1 |

Specifications :
 Square Drive..... 1"
 Free Speed (R.P.M.)..... 4000
 Max. Torque (Ft/Lbs) / (N-M).... 1800 /2439
 Air Pressure (PSI)..... 90
 AIR Inlet (P.T.)..... 1/2"
 Air Consumption (C.F.M.)..... 12



1"DR. Super duty

| Part no. | mm | kg | pc/box |
|--------------|-------------|------|--------|
| 82586 | <i>l</i> | | |
| 82586 | 367mm-14.5" | 10.6 | 1 |

Specifications :
 Free Speed (R.P.M.).....4000
 Max. Torque (Ft/Lb)1500
 Air Inlet (P.T.)1/2"
 Air Pressure (PSI)90

1"DR. Super duty with 6"anvil

| Part no. | mm | kg | pc/box |
|---------------|-----------|------|--------|
| 82586L | <i>l</i> | | |
| 82586S | 533mm-21" | 11.1 | 1 |

Specifications :
 Free Speed (R.P.M.).....4000
 Max. Torque (Ft/Lb)1500
 Air Inlet (P.T.) 1/2"
 Air Pressure (PSI)90



1-1/2" DR. 6pt. Flank impact socket

| 4125 | | <i>l</i> | | |
|----------|--------|----------|------|--------|
| Part no. | Socket | mm | kg | pc/box |
| 412541 | 41 | 80 | 2.23 | 1 |
| 412542 | 42 | 80 | 2.25 | 1 |
| 412546 | 46 | 84 | 2.34 | 1 |
| 412550 | 50 | 84 | 2.39 | 1 |
| 412552 | 52 | 84 | 2.45 | 1 |
| 412554 | 54 | 84 | 2.37 | 1 |
| 412555 | 55 | 90 | 2.51 | 1 |
| 412558 | 58 | 90 | 2.32 | 1 |
| 412560 | 60 | 90 | 2.65 | 1 |
| 412565 | 65 | 95 | 2.99 | 1 |
| 412570 | 70 | 100 | 3.41 | 1 |
| 412575 | 75 | 105 | 3.66 | 1 |
| 412580 | 80 | 110 | 4.55 | 1 |
| 412585 | 85 | 110 | 5.65 | 1 |
| 412590 | 90 | 112 | 5.69 | 1 |
| 412595 | 95 | 112 | 9.24 | 1 |

| 4125 | | <i>l</i> | | |
|----------|--------|----------|-------|--------|
| Part no. | Socket | mm | kg | pc/box |
| 4125100 | 100 | 115 | 9.91 | 1 |
| 4125105 | 105 | 120 | 11.00 | 1 |
| 4125110 | 110 | 124 | 12.64 | 1 |
| 4125115 | 115 | 128 | 12.96 | 1 |
| 4125120 | 120 | 132 | 14.74 | 1 |
| 4125125 | 125 | 136 | 16.10 | 1 |
| 4125130 | 130 | 140 | 16.74 | 1 |
| 4125135 | 135 | 125 | 18.98 | 1 |
| 4125140 | 140 | 150 | 19.62 | 1 |
| 4125150 | 150 | 160 | 23.00 | 1 |

| | | | | |
|-------------|----------|-----|-------|---|
| 41251.5.8 | 1-5/8" | 80 | 2.23 | 1 |
| 41251.11.16 | 1-11/16" | 80 | 2.25 | 1 |
| 41251.3.4 | 1-3/4" | 80 | 2.34 | 1 |
| 41251.13.16 | 1-13/16" | 84 | 2.39 | 1 |
| 41251.15.16 | 1-15/16" | 84 | 2.45 | 1 |
| 41252.0 | 2" | 84 | 2.37 | 1 |
| 41252.1.16 | 2-1/16" | 84 | 2.51 | 1 |
| 41252.1.8 | 2-1/8" | 84 | 2.32 | 1 |
| 41252.3.16 | 2-3/16" | 90 | 2.65 | 1 |
| 41252.1.4 | 2-1/4" | 90 | 2.66 | 1 |
| 41252.5.16 | 2-5/16" | 90 | 2.76 | 1 |
| 41252.3.8 | 2-3/8" | 90 | 2.80 | 1 |
| 41252.7.16 | 2-7/16" | 95 | 2.85 | 1 |
| 41252.1.2 | 2-1/2" | 95 | 2.89 | 1 |
| 41252.9.16 | 2-9/16" | 95 | 2.99 | 1 |
| 41252.5.8 | 2-5/8" | 100 | 3.22 | 1 |
| 41252.11.16 | 2-11/16" | 100 | 3.41 | 1 |
| 41252.3.4 | 2-3/4" | 100 | 3.43 | 1 |
| 41252.13.16 | 2-13/16" | 105 | 3.46 | 1 |
| 41252.7.8 | 2-7/8" | 105 | 3.56 | 1 |
| 41252.15.16 | 2-15/16" | 105 | 3.66 | 1 |
| 41253.0 | 3" | 105 | 4.35 | 1 |
| 41253.1.8 | 3-1/8" | 110 | 4.55 | 1 |
| 41253.1.4 | 3-1/4" | 110 | 4.55 | 1 |
| 41253.3.8 | 3-3/8" | 110 | 5.65 | 1 |
| 41253.1.2 | 3-1/2" | 112 | 5.69 | 1 |
| 41253.5.8 | 3-5/8" | 112 | 9.02 | 1 |
| 41253.3.4 | 3-3/4" | 112 | 9.24 | 1 |
| 41253.7.8 | 3-7/8" | 115 | 9.91 | 1 |
| 41254.0 | 4" | 120 | 10.23 | 1 |
| 41254.1.8 | 4-1/8" | 120 | 10.89 | 1 |
| 41254.1.4 | 4-1/4" | 124 | 11.00 | 1 |
| 41254.1.2 | 4-1/2" | 128 | 12.96 | 1 |
| 41254.5.8 | 4-5/8" | 132 | 14.64 | 1 |
| 41254.3.4 | 4-3/4" | 132 | 14.74 | 1 |
| 41254.7.8 | 4-7/8" | 136 | 16.10 | 1 |
| 41255.0 | 5" | 140 | 16.74 | 1 |
| 41255.1.4 | 5-1/4" | 145 | 18.98 | 1 |
| 41256.0 | 6" | 165 | 23.00 | 1 |
| 41256.1.2 | 6-1/2" | 175 | 26.00 | 1 |



1-1/2" DR. 6pt. Flank impact deep socket

| 4125D | | <i>l</i> | | |
|----------|--------|----------|-------|--------|
| Part no. | Socket | mm | kg | pc/box |
| 4125D41 | 41 | 115 | 3.00 | 1 |
| 4125D42 | 42 | 115 | 3.00 | 1 |
| 4125D46 | 46 | 125 | 3.40 | 1 |
| 4125D50 | 50 | 135 | 3.80 | 1 |
| 4125D54 | 54 | 135 | 4.00 | 1 |
| 4125D55 | 55 | 135 | 4.10 | 1 |
| 4125D60 | 60 | 135 | 4.30 | 1 |
| 4125D65 | 65 | 145 | 5.20 | 1 |
| 4125D70 | 70 | 145 | 5.70 | 1 |
| 4125D75 | 75 | 155 | 6.50 | 1 |
| 4125D80 | 80 | 165 | 7.20 | 1 |
| 4125D85 | 85 | 165 | 7.40 | 1 |
| 4125D90 | 90 | 175 | 9.40 | 1 |
| 4125D95 | 95 | 175 | 10.00 | 1 |
| 4125D100 | 100 | 185 | 10.50 | 1 |
| 4125D105 | 105 | 195 | 11.00 | 1 |
| 4125D110 | 110 | 195 | 11.50 | 1 |
| 4125D115 | 115 | 195 | 12.00 | 1 |
| 4125D120 | 120 | 205 | 13.00 | 1 |
| 4125D125 | 125 | 205 | 14.00 | 1 |
| 4125D130 | 130 | 205 | 15.00 | 1 |

| | | | | |
|--------------|----------|-----|-------|---|
| 4125D1.5.8 | 1-5/8" | 115 | 3.00 | 1 |
| 4125D1.11.16 | 1-11/16" | 115 | 3.10 | 1 |
| 4125D1.3.4 | 1-3/4" | 115 | 3.20 | 1 |
| 4125D1.13.16 | 1-13/16" | 125 | 3.40 | 1 |
| 4125D1.7.8 | 1-7/8" | 125 | 3.50 | 1 |
| 4125D1.15.16 | 1-15/16" | 125 | 3.60 | 1 |
| 4125D2.0 | 2" | 135 | 3.80 | 1 |
| 4125D2.1.16 | 2-1/16" | 135 | 3.90 | 1 |
| 4125D2.1.8 | 2-1/8" | 135 | 4.00 | 1 |
| 4125D2.3.16 | 2-3/16" | 135 | 4.10 | 1 |
| 4125D2.1.4 | 2-1/4" | 135 | 4.20 | 1 |
| 4125D2.3.8 | 2-3/8" | 135 | 4.30 | 1 |
| 4125D2.7.16 | 2-7/16" | 135 | 4.40 | 1 |
| 4125D2.1.2 | 2-1/2" | 135 | 4.60 | 1 |
| 4125D2.9.16 | 2-9/16" | 145 | 5.20 | 1 |
| 4125D2.5.8 | 2-5/8" | 145 | 5.30 | 1 |
| 4125D2.11.16 | 2-11/16" | 154 | 5.50 | 1 |
| 4125D2.3.4 | 2-3/4" | 145 | 5.70 | 1 |
| 4125D2.13.16 | 2-13/16" | 145 | 5.90 | 1 |
| 4125D2.7.8 | 2-7/8" | 145 | 6.10 | 1 |
| 4125D2.15.16 | 2-15/16" | 155 | 6.50 | 1 |
| 4125D3.0 | 3" | 155 | 6.80 | 1 |
| 4125D3.1.8 | 3-1/8" | 165 | 7.50 | 1 |
| 4125D3.3.4 | 3-3/4" | 175 | 10.00 | 1 |
| 4125D3.7.8 | 3-7/8" | 175 | 11.00 | 1 |



1-1/2" DR. Impact extension (Pin type)

| 80412..MPP | <i>l</i> | | |
|----------------------------|-----------|------|--------|
| Part no. | mm | kg | pc/box |
| 80412250MPP | 250-10" | 4.96 | 1 |
| 80412330MPP ^{NEW} | 330-13" | 5.20 | 1 |
| 80412380MPP | 380-15" | 6.58 | 1 |
| 80412500MPP | 500-19.6" | 8.42 | 1 |



1-1/2" DR. Adaptor (Pin type)

| 80912..MPP | <i>l</i> | | | |
|------------|---------------------|-----|------|--------|
| Part no. | size | mm | kg | pc/box |
| 809128MPP | 1-1/2"(F)x1"(M) | 98 | 2.47 | 1 |
| 8091220MPP | 1-1/2"(F)x2-1/2"(M) | 115 | 3.80 | 1 |

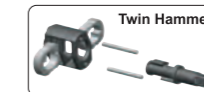

1-1/2" DR. Impact wrench

| 825121 | <i>l</i> | | |
|----------|-------------|------|--------|
| Part no. | mm | kg | pc/box |
| 825121 | 452mm-17.8" | 15.8 | 1 |

Specifications :

Square Drive..... 1-1/2"
 Free Speed (R.P.M.)..... 3000
 Max. Torque (Ft/Lbs) / (N-M).... 2500 / 3388
 Air Pressure (PSI)..... 90
 AIR Inlet (P.T.)..... 1/2"
 Air Consumption (C.F.M.)..... 14.5

* Side exhaust



2-1/2" DR. 6pt. Flank impact socket

| 4205 | | <i>l</i> | | |
|-------------|----------|----------|-------|--------|
| Part no. | Socket | mm | kg | pc/box |
| 420550 | 50 | 115 | 7.20 | 1 |
| 420555 | 55 | 115 | 7.30 | 1 |
| 420560 | 60 | 125 | 7.50 | 1 |
| 420565 | 65 | 125 | 7.60 | 1 |
| 420570 | 70 | 125 | 7.70 | 1 |
| 420575 | 75 | 125 | 7.80 | 1 |
| 420580 | 80 | 125 | 7.90 | 1 |
| 420585 | 85 | 132 | 8.00 | 1 |
| 420590 | 90 | 132 | 8.30 | 1 |
| 420595 | 95 | 140 | 10.00 | 1 |
| 4205100 | 100 | 142 | 11.00 | 1 |
| 4205105 | 105 | 146 | 11.50 | 1 |
| 4205110 | 110 | 155 | 12.00 | 1 |
| 4205115 | 115 | 158 | 13.50 | 1 |
| 4205120 | 120 | 160 | 15.00 | 1 |
| 4205125 | 125 | 165 | 16.00 | 1 |
| 4205130 | 130 | 170 | 17.50 | 1 |
| 4205135 | 135 | 175 | 19.00 | 1 |
| 4205140 | 140 | 180 | 21.00 | 1 |
| 4205145 | 145 | 183 | 23.00 | 1 |
| 4205150 | 150 | 192 | 25.50 | 1 |
| 4205160 | 160 | 200 | 30.00 | 1 |
| 4205165 | 165 | 204 | 32.00 | 1 |
| 4205170 | 170 | 207 | 34.00 | 1 |
| 4205175 | 175 | 210 | 36.00 | 1 |
| 4205180 | 180 | 214 | 40.00 | 1 |
| 4205185 | 185 | 218 | 42.00 | 1 |
| 4205190 | 190 | 220 | 47.00 | 1 |
| 4205200 | 200 | 225 | 51.00 | 1 |
| 4205210 | 210 | 235 | 57.00 | 1 |
| 4205215 | 215 | 240 | 60.00 | 1 |
| 4205225 | 225 | 250 | 70.00 | 1 |
| 4205235 | 235 | 260 | 77.00 | 1 |
| 42052.3.8 | 2-3/8" | 125 | 7.20 | 1 |
| 42052.7.16 | 2-7/16" | 125 | 7.30 | 1 |
| 42052.1.2 | 2-1/2" | 125 | 7.40 | 1 |
| 42052.9.16 | 2-9/16" | 125 | 7.50 | 1 |
| 42052.5.8 | 2-5/8" | 125 | 7.60 | 1 |
| 42052.11.16 | 2-11/16" | 125 | 7.70 | 1 |
| 42052.3.4 | 2-3/4" | 125 | 7.80 | 1 |
| 42052.13.16 | 2-13/16" | 125 | 7.85 | 1 |
| 42052.7.8 | 2-7/8" | 125 | 7.90 | 1 |
| 42052.15.16 | 2-15/16" | 125 | 7.95 | 1 |
| 42053.0 | 3" | 125 | 8.00 | 1 |
| 42053.1.8 | 3-1/8" | 125 | 8.05 | 1 |
| 42053.1.4 | 3-1/4" | 125 | 8.10 | 1 |
| 42053.3.8 | 3-3/8" | 132 | 8.15 | 1 |

| 4205 | | <i>l</i> | | |
|-----------|--------|----------|-------|--------|
| Part no. | Socket | mm | kg | pc/box |
| 42053.5.8 | 3-5/8" | 132 | 8.80 | 1 |
| 42053.3.4 | 3-3/4" | 140 | 10.00 | 1 |
| 42053.7.8 | 3-7/8" | 140 | 10.50 | 1 |
| 42054.0 | 4" | 142 | 11.00 | 1 |
| 42054.1.8 | 4-1/8" | 142 | 11.50 | 1 |
| 42054.1.4 | 4-1/4" | 155 | 12.00 | 1 |
| 42054.1.2 | 4-1/2" | 158 | 13.00 | 1 |
| 42054.5.8 | 4-5/8" | 160 | 14.00 | 1 |
| 42054.7.8 | 4-7/8" | 165 | 16.00 | 1 |
| 42055.0 | 5" | 165 | 17.00 | 1 |
| 42055.1.4 | 5-1/4" | 175 | 19.00 | 1 |
| 42055.3.8 | 5-3/8" | 180 | 20.00 | 1 |
| 42055.1.2 | 5-1/2" | 180 | 21.00 | 1 |
| 42055.5.8 | 5-5/8" | 182 | 22.00 | 1 |
| 42055.3.4 | 5-3/4" | 192 | 24.00 | 1 |
| 42056.0 | 6" | 196 | 28.00 | 1 |
| 42056.1.8 | 6-1/8" | 196 | 29.00 | 1 |
| 42056.5.8 | 6-5/8" | 205 | 33.00 | 1 |
| 42057.0 | 7" | 213 | 39.00 | 1 |



2-1/2" DR. 6pt. Flank impact deep socket

| 4205D | | <i>l</i> | | |
|----------|--------|----------|-------|--------|
| Part no. | Socket | mm | kg | pc/box |
| 4205D75 | 75 | 190 | 11.00 | 1 |
| 4205D80 | 80 | 190 | 12.00 | 1 |
| 4205D85 | 85 | 195 | 13.00 | 1 |
| 4205D90 | 90 | 205 | 14.00 | 1 |
| 4205D95 | 95 | 210 | 14.50 | 1 |
| 4205D100 | 100 | 215 | 15.00 | 1 |
| 4205D105 | 105 | 220 | 18.00 | 1 |
| 4205D110 | 110 | 225 | 19.00 | 1 |
| 4205D115 | 115 | 230 | 20.00 | 1 |
| 4205D120 | 120 | 235 | 24.00 | 1 |
| 4205D125 | 125 | 238 | 25.00 | 1 |
| 4205D130 | 130 | 243 | 26.00 | 1 |
| 4205D135 | 135 | 248 | 27.00 | 1 |
| 4205D140 | 140 | 248 | 28.00 | 1 |
| 4205D145 | 145 | 248 | 29.00 | 1 |
| 4205D150 | 150 | 255 | 30.00 | 1 |
| 4205D155 | 155 | 255 | 32.00 | 1 |
| 4205D160 | 160 | 260 | 35.00 | 1 |
| 4205D165 | 165 | 260 | 36.00 | 1 |
| 4205D170 | 170 | 265 | 37.00 | 1 |
| 4205D175 | 175 | 270 | 39.00 | 1 |



2-1/2" DR. Impact extension (Pin type)

| 80420..MPP | <i>l</i> | | |
|-------------|----------|-------|--------|
| Part no. | mm | kg | pc/box |
| 80420250MPP | 250-10" | 18.00 | 1 |
| 80420500MPP | 500-20" | 27.00 | 1 |



2-1/2" DR. Adaptor (Pin type)

| 80920..MPP | <i>l</i> | | | |
|------------|---------------------|-----|------|--------|
| Part no. | size | mm | kg | pc/box |
| 8092012MPP | 2-1/2"(F)x1-1/2"(M) | 145 | 7.20 | 2 |



3-1/2" DR. 6pt. Flank impact socket

| 4285 | | <i>l</i> | | |
|----------|--------|----------|-------|--------|
| Part no. | Socket | mm | kg | pc/box |
| 4285105 | 105 | 176 | 19.00 | 1 |
| 4285110 | 110 | 179 | 20.00 | 1 |
| 4285115 | 115 | 183 | 21.00 | 1 |
| 4285120 | 120 | 185 | 22.00 | 1 |
| 4285125 | 125 | 190 | 23.00 | 1 |
| 4285130 | 130 | 194 | 25.00 | 1 |
| 4285135 | 135 | 200 | 27.00 | 1 |
| 4285140 | 140 | 205 | 28.00 | 1 |
| 4285145 | 145 | 207 | 30.00 | 1 |
| 4285150 | 150 | 212 | 31.00 | 1 |
| 4285155 | 155 | 218 | 33.00 | 1 |
| 4285160 | 160 | 220 | 35.00 | 1 |
| 4285165 | 165 | 224 | 38.00 | 1 |
| 4285170 | 170 | 227 | 39.00 | 1 |
| 4285175 | 175 | 230 | 41.00 | 1 |
| 4285180 | 180 | 234 | 45.00 | 1 |
| 4285185 | 185 | 238 | 50.00 | 1 |
| 4285190 | 190 | 240 | 54.00 | 1 |
| 4285200 | 200 | 245 | 59.00 | 1 |
| 4285210 | 210 | 255 | 65.00 | 1 |
| 4285215 | 215 | 260 | 68.00 | 1 |
| 4285225 | 225 | 270 | 76.00 | 1 |
| 4285235 | 235 | 280 | 80.00 | 1 |



Suitcase with 30 pcs of tools

| | | |
|-----------------|--|--|
| 50234-30 |  |  |
| Part no. | 1/16.5/17.8/1.65' | 16.5kg |

Content:



| | |
|----------------|---|
| 711 1N...2N | 2-Insulated phillips screwdriver PH.1; PH.2 |
| 713 03N...065N | 4-Insulated slotted screwdriver 3; 4; 5.5; 6.5 mm |
| 6982 | 1-Technician's scissors 145mmL |
| 88404 | 1-Screwdriver probe 110~250V AC voltage tester |
| 5055P4 | 1-Utility knife (incl. 2pc blades) |



| | |
|-----------------|-------------------------------------|
| 827A31 | 1-Cordless drill (charger included) |
| 66303 | 1-Hacksaw 315mmL |
| 5096P803 | 1-Measuring tape 3M |
| 21111 | 11pc bit combination set |
| 12125 0...3 | Phillips PH.0; PH.1; PH.2; PH.3 |
| 122250 0...3 | Pozidriv PZ.0; PZ.1; PZ.2; PZ.3 |
| 12325 055...065 | Slotted 5.5; 6.5 mm |
| 81260Q | Magnetic quick-release bit holder |



| | |
|---------|--|
| 649250A | 1-Adjustable gauged wrench 10" (250mmL) |
| 6904160 | 1-Insulated long nose pliers 6" |
| 6903180 | 1-Insulated combination pliers 7" |
| 6905160 | 1-Insulated diagonal cutting pliers 6" |
| 6912160 | 1-Insulated wire stripper pliers 6" |
| 6907250 | 1-Insulated water pump pliers 10" (Curved jaw) |



1/2"DR. Cordless impact wrench

| | | |
|---------------|---|---|
| 825A41 |  |  |
| Part no. | 4/24.5/25.5/2.69' | 3kg |

Specifications :



| | |
|-------------------------------------|--|
| Square Drive | 13mm |
| Free Speed (R.P.M.) | 2000 |
| Max. Torque (ft-lb) / (kg-cm) | 300/4100 |
| Impacts Per Minute | 2600 |
| Voltage (V d.c.) | 19.2 |
| Charging Time (Hour)..... | 1 hour (AUTO CUT-OFF) |
| Capability | A fully charged battery pack can tighten and loose 150 pcs of 21mm wheel nut |

*Charger included

NEW



1/2"DR. Cordless impact wrench + 19.2V Battery

| | | |
|------------------------|---|---|
| 825A41+ 825B192 |  |  |
| Part no. | 4/24.5/25.5/2.69' | 6kg |

| | |
|---------|---|
| 825A41 | Content: |
| 825B192 | 1/2"DR. Cordless impact wrench 19.2V Battery |



Cordless drill

| | | |
|---------------|---|---|
| 827A31 |  |  |
| Part no. | 6/24.2/25.2/2.5' | 1kg |

Specifications :



| | |
|------------------------------------|---|
| Free Speed (R.P.M.) | Low: 0-325 High: 0-1170 |
| Max. Torque (in-lb) / (kg-cm)..... | 300/350 |
| Voltage (V d.c.) | 14.4 |
| Charging Time (Hour)..... | 1 hour (AUTO CUT-OFF) |
| Clutch | 17 Sections |
| Capability | A fully charged battery pack can tighten 300 pcs of 4.1x38mmL carpenter screw to a pine board |
| Chuck Capability..... | Keyless 10mm |

*Charger included.

NEW



Cordless drill + 14.4V Battery

| | | |
|------------------------|---|---|
| 827A31+ 825B144 |  |  |
| Part no. | 6/24.2/25.2/2.5' | 4kg |

| | |
|---------|---------------------------------|
| 827A31 | Content: |
| 825B144 | Cordless drill 14.4V Battery |



4-1/2" Cordless angle grinder

| | | |
|---------------|---|---|
| 826A01 |  |  |
| Part no. | 4/21.0/22.0/3' | 2.2kg |

Specifications :

| | | | |
|--------------------------|--------|---------------------------|-----------------------|
| Square Drive..... | 6.35mm | Wheel Size..... | 4-1/2" |
| Free Speed (R.P.M.)..... | 7000 | Charging Time (Hour)..... | 1 hour (AUTO CUT-OFF) |
| Voltage (V d.c.)..... | 19.2 | | |

*Charger included

NEW



4-1/2" Cordless angle grinder + 19.2V Battery

| | | |
|------------------------|---|---|
| 826A01+ 825B192 |  |  |
| Part no. | 4/21.0/22.0/3' | 5.3kg |

| | |
|---------|--|
| 826A01 | Content: |
| 825B192 | 4-1/2" Cordless angle grinder 19.2V Battery |

NEW



1/4" Cordless impact driver +3.6V Battery

| | | |
|--------------------------|---|---|
| 828A21L+ 825B036L |  |  |
| Part no. | 10/10/11/2.4' | 1kg |

| | |
|----------|--|
| 828A22L | Content: |
| 825B036L | 1/4" Cordless impact driver 3.6V Li-Ion Battery |

NEW



1/4" Cordless impact screwdriver (Li-Ion)

| | | |
|----------------|---|---|
| 828A21L |  |  |
| Part no. | 10/16.0/17.0/2.4' | 0.4kg |

Specifications :



| | | | |
|--------------------------|-----------------------------------|---------------------------|---|
| Free Speed (R.P.M.)..... | Low: 220 High: 450 | Capability..... | A fully charged battery pack can tighten 457 pcs of TP3x12mmL carpenter screw to a pine board |
| Max. Torque (kg-cm)..... | Electrically: 40 Manually: 250 | Charging Time (Hour)..... | 1 hour (AUTO CUT-OFF) |
| Voltage (V d.c.)..... | 3.6 | | |

*Charger included

NEW



1/4" Cordless impact driver



| | | |
|---------------|---|---|
| 828A22 |  |  |
| Part no. | 6/25.8/26.8/2.5' | 1.7kg |

Specifications :

| | |
|-------------------------------------|---|
| Free Speed (R.P.M.)..... | 0-2300 |
| Max. Torque (ft-lb) / (kg-cm) | 72/1000 |
| Impacts Per Minute | 3000 |
| Voltage (V d.c.) | 12 |
| Capability | A fully charged battery pack can tighten 170 pcs of 4.1x38mmL carpenter screw to a pine board |
| Charging Time (Hour)..... | 1 hour (AUTO CUT-OFF) |

*Charger included

1/4" Cordless impact driver +12V Battery

| | | |
|------------------------|---|---|
| 828A22+ 825B120 |  |  |
| Part no. | 6/25.8/26.8/2.5' | 4.3kg |

| | |
|---------|--|
| 828A22 | Content: |
| 825B120 | 1/4" Cordless impact driver 12V Battery |

| Part No. | Page | Part No. | Page | Part No. | Page | Part No. | Page | Part No. | Page |
|------------|------|----------|------|----------|------|-----------|------|-----------|------|
| 10210H1 | 1-09 | 123... | 4-24 | 20810 | 3-03 | 2125 | 3-09 | 2405Q | 4-14 |
| 10210H2 | 1-09 | 123D... | 4-24 | 20810B | 3-03 | 2125P1 | 2-50 | 241... | 9-20 |
| 10210H3 | 1-09 | 123S... | 4-27 | 2081A | 4-02 | 2126 | 1-21 | 241060... | 9-20 |
| 10210H4 | 1-09 | 124... | 4-25 | 2081B | 4-02 | 2126 | 3-09 | 242... | 9-20 |
| 10215 | 1-06 | 124D... | 4-25 | 2081C | 4-03 | 21310 | 3-06 | 2421 | 4-15 |
| 10215A | 1-06 | 124R... | 4-27 | 2081D | 4-03 | 2133 | 4-06 | 2421BF | 4-16 |
| 10215B | 1-06 | 124S... | 4-27 | 2083 | 4-03 | 2133-5 | 4-06 | 2421F | 4-16 |
| 10215R | 1-06 | 125... | 4-25 | 2084 | 3-02 | 2134 | 1-21 | 243... | 9-20 |
| 10216 | 1-06 | 126... | 4-26 | 2085 | 3-03 | 2134 | 3-04 | 244... | 9-21 |
| 10216-245 | 1-12 | 126D... | 4-26 | 2086 | 3-03 | 2137 | 1-21 | 244060... | 9-20 |
| 10216A | 1-06 | 127... | 4-26 | 2086T | 3-03 | 2137 | 3-05 | 246... | 9-21 |
| 10216A-245 | 1-12 | 128... | 4-26 | 2087 | 3-11 | 2137T | 1-21 | 246060... | 9-21 |
| 10216B | 1-06 | 12F... | 4-27 | 2088 | 3-12 | 2137T | 3-05 | 2461 | 4-17 |
| 10216B-245 | 1-12 | 151... | 5-18 | 2088T | 3-12 | 2138Q | 4-06 | 2461-5 | 4-17 |
| 10216R | 1-06 | 152... | 5-18 | 20915 | 3-03 | 2141 | 1-21 | 2462 | 4-17 |
| 10216R-245 | 1-12 | 153... | 5-19 | 20916 | 3-09 | 2141 | 3-10 | 2462-7 | 4-17 |
| 10217 | 1-07 | 154... | 5-19 | 2095 | 1-21 | 21410 | 3-06 | 2462-9 | 4-17 |
| 10217-245 | 1-12 | 156... | 5-20 | 2095 | 3-45 | 2141T | 1-21 | 248... | 9-22 |
| 10217-286 | 1-13 | 157... | 5-20 | 2095S | 1-21 | 2141T | 3-10 | 248060... | 9-22 |
| 10217A | 1-07 | 174... | 6-69 | 2095S | 3-45 | 2142 | 1-21 | 2502 | 4-18 |
| 10217A-245 | 1-12 | 176... | 6-69 | 2096 | 1-21 | 2142 | 3-05 | 2502-7 | 4-18 |
| 10217A-286 | 1-13 | 177... | 6-70 | 2096 | 3-45 | 2143 | 3-05 | 2502-9 | 4-18 |
| 10217B | 1-07 | 178... | 6-70 | 2097 | 1-21 | 2144Q | 4-06 | 2571 | 4-19 |
| 10217B-245 | 1-12 | 179... | 6-71 | 2097 | 3-10 | 2161 | 3-12 | 2591 | 4-19 |
| 10217B-286 | 1-13 | 196... | 6-69 | 2097B | 1-21 | 2203 | 4-06 | 2611A | 4-20 |
| 10217R | 1-07 | 20268 | 3-01 | 2097B | 3-10 | 2203-5 | 4-06 | 2611B | 4-20 |
| 10217R-245 | 1-12 | 2044 | 3-01 | 2097S | 1-21 | 2203-72 | 4-07 | 2641 | 4-21 |
| 10217R-286 | 1-13 | 2044S | 3-01 | 2097S | 3-10 | 2203-72-5 | 4-07 | 26490... | 9-31 |
| 10218 | 1-07 | 2044ST | 3-01 | 2101 | 4-03 | 2204 | 3-13 | 2741 | 4-21 |
| 10218-245 | 1-12 | 2045 | 4-01 | 21010 | 4-03 | 2222 | 4-07 | 2742 | 4-22 |
| 10218-286 | 1-13 | 2046 | 4-01 | 21011 | 4-04 | 2253 | 4-08 | 2742-18 | 4-22 |
| 10218A | 1-07 | 2048 | 3-01 | 21012 | 4-04 | 2253-72 | 4-08 | 2751 | 3-07 |
| 10218A-245 | 1-12 | 2048T | 3-01 | 21012T | 4-04 | 2255 | 4-08 | 2752 | 3-07 |
| 10218A-286 | 1-13 | 2057 | 3-09 | 21013 | 4-04 | 2261 | 3-13 | 2753 | 3-07 |
| 10218B | 1-07 | 2058 | 3-10 | 21014 | 4-04 | 2263 | 4-08 | 2753T | 3-07 |
| 10218B-245 | 1-12 | 2061 | 3-01 | 2101L | 4-03 | 2281 | 4-09 | 3051 | 5-01 |
| 10218B-286 | 1-13 | 20610 | 3-02 | 21021 | 4-23 | 2281-5 | 4-09 | 3051M | 5-01 |
| 10218R | 1-07 | 2061T | 3-01 | 21022 | 4-23 | 2281-72 | 4-09 | 3062 | 5-01 |
| 10218R-245 | 1-12 | 2062 | 4-01 | 2106 | 3-12 | 2281-72-5 | 4-09 | 3063 | 9-04 |
| 10218R-286 | 1-13 | 2064 | 3-11 | 2108 | 1-21 | 2281S | 4-09 | 3064 | 5-01 |
| 10225 | 1-05 | 2065 | 3-11 | 2108 | 3-04 | 2292 | 4-10 | 3065 | 5-01 |
| 10225-183 | 1-11 | 2066 | 3-11 | 2109 | 1-21 | 2292-7 | 4-10 | 3065S | 5-01 |
| 10225R | 1-05 | 2069 | 3-01 | 2109 | 3-04 | 2292-9 | 4-10 | 3071 | 5-01 |
| 10225R-183 | 1-11 | 2071 | 4-01 | 21110 | 4-05 | 2303 | 4-10 | 30710S | 5-03 |
| 10318 | 1-08 | 20711 | 4-01 | 21110D | 4-05 | 2312 | 4-11 | 30711 | 5-03 |
| 10318-437 | 1-14 | 20712 | 3-08 | 21110D-5 | 4-05 | 2312-5 | 4-11 | 30712 | 5-03 |
| 10318B | 1-08 | 20713 | 3-02 | 21111 | 4-05 | 2312-72 | 4-11 | 3072 | 5-02 |
| 10318B-437 | 1-14 | 20714 | 3-02 | 21112 | 4-05 | 2312-75-5 | 4-11 | 3073 | 5-02 |
| 10318R | 1-08 | 20715 | 3-08 | 21113 | 4-05 | 2313 | 4-12 | 3074 | 5-02 |
| 10318R-437 | 1-14 | 20717 | 3-02 | 21113T | 4-05 | 2314A | 4-12 | 3075 | 5-02 |
| 121... | 4-24 | 20718 | 3-08 | 21115 | 4-06 | 2314B | 4-12 | 3075S | 5-02 |
| 121D... | 4-24 | 20718-3 | 3-08 | 2111I | 4-04 | 2315 | 4-13 | 3075SK | 5-02 |
| 121S... | 4-27 | 20719 | 3-02 | 2112I | 4-04 | 2331 | 4-13 | 3076 | 5-02 |
| 122... | 4-24 | 2073 | 4-02 | 2119 | 3-04 | 23452... | 9-06 | 3076L | 5-02 |
| 122D... | 4-24 | 2073S | 4-02 | 2119T | 3-04 | 23652... | 9-06 | 3077S | 5-03 |
| 122S... | 4-27 | 2081 | 4-02 | 2125 | 1-21 | 2402 | 4-14 | 3078 | 5-03 |

| Part No. | Page | Part No. | Page | Part No. | Page | Part No. | Page | Part No. | Page |
|-----------|------|-----------|------|----------|------|----------|------|-----------------|------|
| 3081 | 5-04 | 3322 | 5-12 | 4046B | 9-11 | 41081-5 | 6-54 | 4173S-9 | 6-14 |
| 3082 | 5-04 | 3322-15 | 5-12 | 4051 | 6-01 | 41081-9 | 6-54 | 4181 | 6-14 |
| 3082S | 5-04 | 3322-23 | 5-12 | 4056 | 6-01 | 41082 | 6-55 | 4181-7 | 6-14 |
| 3083 | 9-04 | 3322-24 | 5-12 | 4057 | 6-01 | 41082-9 | 6-55 | 4181-9 | 6-14 |
| 3083S | 9-04 | 333... | 5-21 | 4059 | 6-02 | 4109 | 9-14 | 4192 | 6-14 |
| 3084 | 9-05 | 334... | 5-21 | 4061 | 6-02 | 4109S | 9-14 | 4193 | 9-17 |
| 3084S | 9-05 | 335... | 5-22 | 40612 | 6-03 | 41101 | 6-56 | 4194 | 6-15 |
| 3091 | 5-04 | 3351 | 5-13 | 40613 | 6-03 | 4111 | 6-08 | 4194-7 | 6-15 |
| 3092 | 5-04 | 3351-5 | 5-13 | 40613-23 | 6-03 | 4111S | 6-08 | 4194-9 | 6-15 |
| 3093 | 5-04 | 336... | 5-22 | 40615 | 6-03 | 4112 | 6-09 | 4205 | 9-17 |
| 3093S | 5-04 | 336...U | 2-65 | 4062 | 6-02 | 4113 | 6-09 | 4205... | 9-45 |
| 3094 | 5-05 | 3361 | 5-13 | 4066 | 6-02 | 4116 | 6-09 | 4205D... | 9-45 |
| 3095 | 5-05 | 3361-7 | 5-13 | 4071 | 6-03 | 4117 | 9-15 | 4211 | 6-15 |
| 3101 | 5-05 | 3361-9 | 5-13 | 40710 | 9-12 | 4118 | 9-15 | 4212 | 6-16 |
| 3103 | 5-05 | 337... | 5-23 | 40711 | 6-04 | 4118-2 | 9-15 | 4212-7 | 6-16 |
| 3105 | 5-05 | 338... | 5-23 | 40711-9 | 6-04 | 4119 | 9-15 | 4212-9 | 6-16 |
| 3108Q | 5-06 | 339... | 5-23 | 4072 | 6-04 | 4122 | 6-09 | 4213 | 6-16 |
| 3111 | 5-06 | 3391 | 5-14 | 4073 | 9-11 | 4124Q | 6-10 | 4214 | 6-17 |
| 3112 | 5-06 | 3391-5 | 5-14 | 4074 | 6-04 | 4125... | 9-43 | 4214-7 | 6-17 |
| 3113S | 5-06 | 33F... | 5-23 | 4075 | 6-04 | 4125D... | 9-44 | 4214-9 | 6-17 |
| 3114 | 5-06 | 341... | 6-71 | 4077 | 9-11 | 41391 | 6-57 | 4215 | 1-21 |
| 3121 | 5-06 | 342... | 6-71 | 4078 | 9-12 | 4141 | 6-10 | 4215 | 9-17 |
| 3122Q | 5-07 | 343... | 6-71 | 4081 | 6-04 | 4142 | 9-16 | 4216 | 9-18 |
| 3142 | 5-07 | 344... | 6-72 | 40811 | 6-06 | 41421 | 6-58 | 4222 | 6-17 |
| 3151 | 5-07 | 3441 | 5-14 | 4081-3 | 6-04 | 41421-9 | 6-58 | 4223 | 6-18 |
| 3171 | 5-07 | 34410508B | 2-65 | 4082 | 6-05 | 4142-3 | 9-16 | 4223-7 | 6-18 |
| 3171T | 5-07 | 345... | 6-73 | 4082S | 6-05 | 4142-4 | 9-16 | 4223-9 | 6-18 |
| 3193 | 5-08 | 3451 | 5-15 | 4083 | 6-05 | 4142B | 9-16 | 4225 | 6-18 |
| 321... | 4-28 | 346... | 6-73 | 4084 | 6-05 | 4143 | 6-10 | 4234A | 6-62 |
| 3212 | 5-08 | 347... | 6-74 | 4084S | 6-05 | 4143-9 | 6-10 | 4234A+2421 | 6-62 |
| 3213 | 5-08 | 348... | 6-75 | 4085 | 6-05 | 41451D | 9-19 | 4234A+4102 | 6-63 |
| 322... | 4-28 | 348...T | 6-75 | 4085S | 6-06 | 41451S | 9-19 | 4234B | 6-63 |
| 3222 | 5-08 | 348...T | 2-65 | 4091 | 6-06 | 41512 | 6-11 | 4234B+2641 | 6-64 |
| 3224 | 5-09 | 349... | 6-75 | 40911 | 6-07 | 4155 | 6-10 | 4234B+3251-5 | 6-64 |
| 323... | 4-28 | 349...T | 6-76 | 40911-9 | 6-07 | 4156 | 6-11 | 4234B+3361 | 6-65 |
| 3232 | 5-09 | 3511 | 5-15 | 40912 | 9-13 | 4157 | 6-11 | 4234B+4411 | 6-65 |
| 3232-7 | 5-09 | 3521 | 5-16 | 4091S | 6-06 | 4158 | 6-11 | 4234B+5161 | 6-66 |
| 3232-9 | 5-09 | 3551 | 5-16 | 4092 | 6-07 | 4161 | 6-12 | 4243 | 6-19 |
| 3233 | 9-05 | 3551-5 | 5-16 | 4093 | 6-07 | 4161-7 | 6-12 | 4243-5 | 6-19 |
| 324... | 4-28 | 3551-9 | 5-16 | 4095 | 6-07 | 4161-9 | 6-12 | 4243-9 | 6-19 |
| 3251 | 5-10 | 3571 | 5-17 | 4101 | 6-07 | 4162 | 6-12 | 4243B | 6-66 |
| 3251-5 | 5-10 | 3571-5 | 5-17 | 41012 | 9-14 | 4162-5 | 6-12 | 4243B+2203-72-5 | 6-67 |
| 3251-5-18 | 5-10 | 3571-72 | 5-17 | 41013 | 9-14 | 4162-7 | 6-12 | 4243B+2253-72 | 6-67 |
| 3251-72 | 5-10 | 3611 | 5-18 | 41014Q | 6-08 | 41631D | 6-59 | 4243B+2281-72-5 | 6-68 |
| 3251-72-5 | 5-10 | 3611-5 | 5-18 | 4101S | 6-07 | 41631D-7 | 6-59 | 4243B+2571 | 6-68 |
| 3251-9 | 5-10 | 364... | 7-05 | 4102 | 6-08 | 41631D-9 | 6-59 | 4243S | 6-19 |
| 3251Q | 5-11 | 366... | 7-05 | 41021 | 6-52 | 41631S | 6-59 | 4243S-5 | 6-19 |
| 326... | 4-28 | 368... | 7-05 | 41021-9 | 6-52 | 41631S-7 | 6-59 | 4243S-9 | 6-19 |
| 3261 | 5-11 | 4031 | 2-01 | 4106 | 6-08 | 41631S-9 | 6-59 | 4245 | 6-20 |
| 3261-7 | 5-11 | 4032 | 9-10 | 4106S | 6-08 | 4171 | 6-13 | 4245-7 | 6-20 |
| 3261-9 | 5-11 | 4032TH | 9-10 | 4107 | 9-13 | 4172 | 6-13 | 4245-9 | 6-20 |
| 327... | 4-29 | 4033 | 9-11 | 41071 | 6-53 | 4173 | 6-13 | 4245B | 6-21 |
| 32F... | 4-29 | 4041 | 6-01 | 41071-9 | 6-53 | 4173-5 | 6-13 | 4245B-7 | 6-21 |
| 3302 | 5-11 | 4042 | 6-01 | 4107S | 9-13 | 4173-9 | 6-13 | 4245B-9 | 6-21 |
| 331... | 5-21 | 4046 | 9-11 | 4108 | 9-14 | 4173S | 6-13 | 4245BS | 6-21 |
| 332... | 5-21 | 4046A | 9-11 | 41081 | 6-54 | 4173S-5 | 6-14 | 4245BS-7 | 6-21 |

| Part No. | Page | Part No. | Page | Part No. | Page | Part No. | Page | Part No. | Page |
|----------|------|-------------------|------|------------|------|----------|------|----------|------|
| 4245S | 6-20 | 4442C | 6-34 | 4821 | 6-47 | 5042S | 2-03 | 50710S | 3-14 |
| 4245S-7 | 6-20 | 4442CT | 6-34 | 4821-5 | 6-48 | 5043A | 2-03 | 50713 | 1-21 |
| 4245S-9 | 6-20 | 445... | 9-22 | 4821-9 | 6-48 | 5044 | 3-29 | 50713B | 2-08 |
| 4246 | 6-21 | 445150...C | 9-23 | 48311021 | 2-85 | 5045 | 2-03 | 50714 | 3-29 |
| 4246-5 | 6-22 | 44552... | 9-23 | 4832 | 6-48 | 5046 | 2-03 | 5071T | 3-42 |
| 4246-9 | 6-22 | 44552...TH | 9-23 | 484... | 9-39 | 5047 | 2-04 | 5072 | 3-33 |
| 4246B | 6-22 | 44585... | 9-23 | 485... | 9-39 | 5047P1 | 2-41 | 50721 | 2-08 |
| 4246B-5 | 6-23 | 44585...C | 9-24 | 485100... | 9-40 | 5047P2 | 2-41 | 50722 | 2-08 |
| 4246B-9 | 6-23 | 44585...TH | 9-24 | 48580... | 9-40 | 5047P3 | 2-42 | 5072BF | 3-39 |
| 4246S | 6-22 | 446... | 9-24 | 488... | 9-40 | 5047P4 | 2-42 | 5072F | 3-34 |
| 4246S-5 | 6-22 | 448... | 9-24 | 4911 | 6-49 | 5048 | 1-21 | 5072FS | 3-34 |
| 4246SB-5 | 6-23 | 44885... | 9-25 | 4911-9 | 6-50 | 5051 | 2-04 | 5072L | 3-34 |
| 4246SB-9 | 6-23 | 4511 | 6-34 | 4921 | 6-50 | 50510 | 2-05 | 5072LB | 3-39 |
| 425... | 9-03 | 4511-5 | 6-35 | 4941 | 6-51 | 50511 | 2-05 | 5072LBS | 3-39 |
| 42507M | 9-03 | 4511-7 | 6-35 | 4941-5 | 6-51 | 50512 | 2-05 | 5072LS | 3-34 |
| 4252 | 6-23 | 4512 | 6-35 | 4941-9 | 6-51 | 5052 | 3-18 | 5072S | 3-33 |
| 4255 | 6-24 | 4512-5 | 6-35 | 50121 | 6-60 | 5053 | 2-04 | 5072XL | 3-34 |
| 426... | 9-03 | 4512-9 | 6-35 | 50121A-429 | 6-60 | 5054 | 2-04 | 5072XLB | 3-39 |
| 4262 | 6-24 | 4541 | 6-36 | 50121B-460 | 6-61 | 5055 | 2-05 | 5072XLBS | 3-39 |
| 4262-7 | 6-24 | 4541-5 | 6-36 | 50121C-408 | 6-61 | 5055P1 | 2-34 | 5072XLS | 3-34 |
| 4262-9 | 6-24 | 4541-7 | 6-36 | 50121E-275 | 9-19 | 5055P4 | 2-33 | 5074 | 3-16 |
| 4281 | 6-25 | 4582 | 6-36 | 50121F-271 | 9-19 | 5056 | 2-05 | 5075 | 3-23 |
| 4283 | 6-25 | 4582-15 | 6-36 | 5021 | 2-01 | 5061 | 2-06 | 5076 | 3-34 |
| 4285... | 9-46 | 4601 | 6-37 | 50212 | 1-08 | 50610 | 3-30 | 5076F | 3-35 |
| 4291 | 6-26 | 4601-5 | 6-37 | 50222S | 1-03 | 50610S | 3-30 | 5076FS | 3-35 |
| 4291-5 | 6-26 | 4601-9 | 6-37 | 50222S-38 | 1-03 | 50612 | 2-06 | 5076S | 3-34 |
| 4291-7 | 6-26 | 4602 | 6-38 | 50223 | 1-05 | 50613 | 2-07 | 5077 | 3-18 |
| 4293 | 9-18 | 461... | 9-32 | 50223-183 | 1-11 | 50614 | 2-07 | 5077S | 3-18 |
| 4312 | 6-26 | 4611 | 6-39 | 50223R | 1-05 | 50616S | 3-15 | 5078 | 2-07 |
| 4321 | 6-27 | 4611-5 | 6-39 | 50223R-183 | 1-11 | 50617 | 3-46 | 5079S | 3-30 |
| 4321-7 | 6-27 | 4611-7 | 6-39 | 50223S | 1-03 | 50619 | 1-22 | 5081 | 3-30 |
| 4324 | 6-27 | 4611-72 | 6-38 | 50223S-116 | 1-03 | 5062 | 3-23 | 50810 | 3-45 |
| 4325 | 6-28 | 46190... | 9-32 | 50229S | 1-03 | 50622 | 3-31 | 50811 | 3-46 |
| 435... | 9-06 | 4641 | 6-40 | 50229S-255 | 1-03 | 50623 | 3-46 | 50812 | 3-24 |
| 435...M | 9-07 | 465... 9-32, 9-33 | | 5023 | 2-01 | 50624 | 3-29 | 50813 | 3-26 |
| 4351 | 6-28 | 4651 | 6-40 | 50230-95 | 1-01 | 5063 | 3-41 | 50814 | 2-08 |
| 4352 | 6-29 | 465100... | 9-33 | 50231-33 | 1-01 | 50634 | 3-32 | 50816 | 1-22 |
| 43563... | 9-07 | 4652 | 6-41 | 50233 | 1-02 | 50635 | 2-07 | 50816 | 3-45 |
| 436... | 9-07 | 4653 | 6-41 | 50233-48 | 1-02 | 50637 | 3-40 | 50817 | 3-33 |
| 4401 | 6-29 | 466110... | 9-33 | 50234 | 1-01 | 50638 | 3-37 | 5081S | 3-30 |
| 4401C | 6-30 | 466110... | 2-65 | 50234-107 | 1-01 | 50638A | 3-37 | 5082 | 3-14 |
| 4401CT | 6-30 | 4671 | 6-42 | 50234-30 | 9-47 | 50639 | 3-38 | 50821 | 3-31 |
| 4401T | 6-29 | 468... | 9-34 | 50235 | 1-02 | 50639A | 3-38 | 50821A | 3-31 |
| 4403 | 6-30 | 4682 | 6-43 | 50235-101 | 1-02 | 5063T | 3-41 | 50823 | 1-22 |
| 4411 | 6-31 | 4682-5 | 6-43 | 50235-124 | 1-02 | 5064 | 2-06 | 5083F | 3-42 |
| 44114 | 9-22 | 4682-9 | 6-43 | 50253 | 1-04 | 5064L | 2-06 | 5083TF | 3-42 |
| 4412 | 6-31 | 4683 | 6-44 | 50253-177 | 1-10 | 5065 | 3-23 | 5084 | 3-16 |
| 4412-5 | 6-31 | 4731 | 6-44 | 50254 | 1-04 | 5066 | 3-14 | 5085 | 3-29 |
| 4421 | 6-32 | 4761 | 6-45 | 50254-177 | 1-10 | 5066S | 3-14 | 5085S | 3-29 |
| 4421C | 6-32 | 4761-5 | 6-45 | 5033 | 3-15 | 5067 | 3-16 | 5086 | 3-19 |
| 4421CT | 6-32 | 4761-9 | 6-45 | 5034 | 2-02 | 5067S | 3-16 | 5086S | 3-19 |
| 4421T | 6-32 | 4771 | 6-46 | 5036 | 2-02 | 5068 | 3-18 | 5087F | 3-42 |
| 4422Q | 6-33 | 4772 | 6-47 | 5036A | 2-02 | 5068S | 3-18 | 5087TF | 3-42 |
| 443... | 2-66 | 481... | 9-38 | 5038 | 2-02 | 5069 | 3-28 | 50910BS | 1-21 |
| 4441C | 6-33 | 48190... | 9-38 | 5041 | 3-23 | 5069S | 3-28 | 50910BS | 3-41 |
| 4441CT | 6-33 | 482... | 9-38 | 5042 | 2-03 | 5071 | 3-42 | 50911 | 1-22 |

| Part No. | Page | Part No. | Page | Part No. | Page | Part No. | Page | Part No. | Page |
|-----------|------|----------|------|------------|------|----------|------|----------|------|
| 50911 | 3-32 | 51213P | 3-31 | 539... | 5-26 | 6111 | 9-30 | 62104 | 2-71 |
| 50912 | 1-22 | 51214 | 3-22 | 53963... | 5-26 | 6111-1 | 9-30 | 62105 | 2-14 |
| 50912 | 3-38 | 51214P | 3-23 | 53Q... | 5-27 | 6111D | 9-30 | 62106 | 2-71 |
| 50913 | 3-44 | 51215 | 3-25 | 53Q63... | 5-27 | 6111D-1 | 9-30 | 6212 | 7-03 |
| 50919 | 3-38 | 51215R | 3-27 | 54111 | 1-22 | 6112 | 9-31 | 6212-5 | 7-03 |
| 5093 | 3-35 | 5121S | 3-20 | 54111P1 | 2-46 | 6113 | 9-31 | 6212S | 7-03 |
| 5093L | 3-35 | 5122 | 2-11 | 545... | 6-76 | 611B... | 2-42 | 623... | 2-70 |
| 5093LB | 3-39 | 5123 | 3-20 | 54577... | 6-77 | 612140 | 2-43 | 6241 | 7-04 |
| 5093LBS | 3-39 | 5128P | 3-18 | 546... | 6-77 | 612175 | 2-43 | 6241-72 | 7-04 |
| 5093LS | 3-35 | 5131 | 2-11 | 546150...B | 6-78 | 612B... | 2-43 | 62501 | 2-72 |
| 5093S | 3-35 | 5134 | 3-20 | 54677... | 6-78 | 613... | 2-43 | 62502 | 2-72 |
| 5093XL | 3-35 | 5135S | 3-14 | 547... | 6-78 | 613A500 | 2-43 | 62503 | 2-72 |
| 5093XLB | 3-40 | 5137 | 3-37 | 54777... | 6-79 | 613B250 | 2-43 | 62504 | 2-72 |
| 5093XLBS | 3-40 | 5137S | 3-37 | 548W... | 6-79 | 614... | 2-51 | 62505 | 2-72 |
| 5093XLS | 3-35 | 5137XL | 3-37 | 549... | 6-79 | 6141 | 7-01 | 62506 | 2-72 |
| 5094 | 3-19 | 5138 | 1-22 | 54977... | 6-80 | 6141-5 | 7-01 | 62507 | 2-73 |
| 5096 | 2-09 | 5139 | 1-22 | 54Q... | 6-81 | 6141B | 7-02 | 62508 | 2-73 |
| 5096P8... | 2-35 | 5141 | 3-20 | 54Q77... | 6-81 | 6141B-5 | 7-02 | 62509 | 2-73 |
| 5098 | 3-42 | 5141S | 3-20 | 5501 | 3-44 | 6141S | 7-01 | 62510 | 2-73 |
| 5098L | 3-43 | 5144 | 3-33 | 565... | 7-05 | 6141SB | 7-02 | 62511 | 2-73 |
| 5098LB | 3-44 | 5151 | 3-43 | 569... | 7-06 | 6142 | 9-31 | 62512 | 2-73 |
| 5098LT | 3-43 | 5151L | 3-43 | 585... | 8-03 | 614A... | 2-51 | 62513 | 2-74 |
| 5098T | 3-42 | 5151LT | 3-43 | 5861 | 2-13 | 614B225 | 2-51 | 62514 | 2-74 |
| 5099L | 3-43 | 5151T | 3-43 | 589... | 8-04 | 615... | 2-51 | 62515 | 2-74 |
| 5099LT | 3-43 | 5161 | 3-21 | 602... | 2-30 | 616... | 2-32 | 62516 | 2-74 |
| 51010T | 1-22 | 5164 | 3-25 | 602...C | 2-30 | 616A... | 2-32 | 62518 | 2-75 |
| 51010T | 3-44 | 5164R | 3-28 | 602...Q | 2-30 | 616A400 | 2-32 | 62519 | 2-75 |
| 51014 | 2-09 | 5171 | 2-12 | 603...Q | 2-30 | 616A700 | 2-33 | 62520 | 2-75 |
| 51015 | 1-22 | 5172 | 3-15 | 6031 | 2-13 | 616B... | 2-33 | 62521 | 2-75 |
| 51015 | 2-09 | 5175 | 3-21 | 603150 | 2-30 | 616F... | 2-33 | 62528 | 2-51 |
| 51016 | 2-10 | 5175A | 3-21 | 6032 | 2-14 | 617 | 2-40 | 62601 | 2-84 |
| 5102 | 3-36 | 5176 | 3-16 | 604... | 2-31 | 61701 | 2-39 | 6261 | 7-05 |
| 5102L | 3-36 | 5191 | 3-21 | 604...Q | 2-31 | 61702 | 2-40 | 627... | 2-70 |
| 5102LB | 3-40 | 5191Q | 3-22 | 605... | 2-31 | 61703 | 2-40 | 62701 | 2-71 |
| 5102XL | 3-36 | 5192 | 3-22 | 606... | 2-31 | 617A | 2-13 | 62702 | 2-15 |
| 5102XLB | 3-40 | 5201 | 2-13 | 606...Q | 2-31 | 617L | 2-39 | 628... | 2-78 |
| 5103 | 3-17 | 525... | 4-29 | 6061 | 7-01 | 618 | 2-35 | 62801 | 2-76 |
| 5103S | 3-17 | 52550... | 4-30 | 607... | 2-31 | 61802 | 2-35 | 62802 | 2-76 |
| 5106B | 1-22 | 526... | 4-30 | 607...Q | 2-32 | 61803 | 2-35 | 62805 | 2-76 |
| 5106B | 3-41 | 5261 | 3-21 | 6071 | 9-29 | 619 | 2-68 | 62806 | 2-76 |
| 5109S | 3-36 | 5261P | 3-22 | 608... | 2-64 | 61901A | 2-51 | 6280723 | 2-76 |
| 5111 | 3-17 | 52650... | 4-30 | 6081 | 9-29 | 61904A | 2-68 | 6280728 | 2-77 |
| 51110 | 3-15 | 527... | 4-31 | 6081D | 9-29 | 61908 | 2-68 | 62808 | 2-77 |
| 51112 | 2-10 | 52750... | 4-31 | 6081DS | 9-29 | 61909 | 2-68 | 62809 | 2-77 |
| 5111S | 3-17 | 529... | 4-32 | 6081S | 9-29 | 61910 | 2-68 | 62811 | 2-77 |
| 5112 | 3-17 | 52950... | 4-32 | 6082D | 9-29 | 620... | 2-70 | 62812 | 2-77 |
| 5112S | 3-17 | 52Q... | 4-33 | 6082DS | 9-29 | 62001 | 2-14 | 62813 | 2-78 |
| 5115 | 3-19 | 52Q50... | 4-33 | 609...ABC | 2-45 | 6201 | 7-02 | 62814 | 2-78 |
| 5115S | 3-19 | 5333 | 2-12 | 609...ABO | 2-45 | 6201-5 | 7-02 | 628E... | 2-78 |
| 5116 | 3-36 | 5341 | 3-47 | 609...ASC | 2-45 | 6201B | 7-03 | 62901 | 2-70 |
| 5116L | 3-36 | 535... | 5-24 | 609...ASO | 2-44 | 6201B-5 | 7-03 | 63005 | 2-15 |
| 5116LB | 3-40 | 53546... | 5-24 | 610... | 2-42 | 6201S | 7-02 | 63006 | 2-15 |
| 5116XL | 3-37 | 53563... | 5-24 | 610110 | 2-42 | 6201SB | 7-03 | 63006B | 2-15 |
| 5121 | 3-20 | 536... | 5-25 | 610B... | 2-42 | 62101 | 2-71 | 63201 | 2-41 |
| 51210 | 3-24 | 537... | 5-25 | 610B...B | 2-42 | 62102 | 2-71 | 634 | 2-84 |
| 51211 | 3-27 | 53763... | 5-26 | 611... | 2-42 | 62103 | 2-71 | 634...A | 2-84 |

| Part No. | Page | Part No. | Page | Part No. | Page | Part No. | Page | Part No. | Page |
|------------|------------|-----------|------|-----------|------|-----------|------|----------|------|
| 639... | 2-69 | 65602 | 2-69 | 66621 | 2-23 | 6907250 | 2-49 | 731... | 3-51 |
| 639230 | 2-69 | 65603 | 2-69 | 66622 | 2-23 | 6908160 | 2-49 | 732... | 3-52 |
| 64101 | 2-15 | 65605 | 2-69 | 66627 | 2-23 | 6909250 | 2-49 | 733... | 3-52 |
| 647... | 2-55, 2-56 | 65607 | 2-69 | 66628 | 2-23 | 6911... | 2-49 | 734... | 3-52 |
| 647...W | 2-56 | 656B | 2-19 | 666A... | 2-83 | 6912160 | 2-49 | 735... | 3-52 |
| 64701L | 2-16 | 656M | 2-18 | 666A01 | 2-24 | 6913160 | 2-49 | 736... | 3-53 |
| 64702L | 2-16 | 65701 | 2-84 | 666A02 | 2-24 | 6914... | 2-49 | 737... | 3-53 |
| 64703 | 2-16 | 65714 | 2-84 | 666A03 | 2-24 | 6921160 | 2-46 | 739... | 3-53 |
| 64704 | 2-16 | 658 | 2-19 | 66901 | 2-40 | 6922160 | 2-46 | 744... | 3-53 |
| 64705 | 2-16 | 65901... | 2-79 | 66902 | 2-40 | 6923... | 2-46 | 750... | 2-64 |
| 64707 | 2-18 | 65902... | 2-79 | 66903 | 2-40 | 6924250 | 2-46 | 751... | 3-54 |
| 64709 | 2-17 | 65903... | 2-79 | 67001 | 2-24 | 6925... | 2-46 | 751...A | 3-53 |
| 64710 | 2-17 | 65906... | 2-79 | 672... | 2-25 | 6941... | 2-45 | 752... | 3-56 |
| 64711 | 2-17 | 6590630 | 2-80 | 673B... | 2-43 | 6943125 | 2-45 | 753 | 3-55 |
| 64712 | 2-17 | 65907... | 2-80 | 674 | 2-25 | 6944160 | 2-45 | 753...A | 3-55 |
| 64713 | 2-17 | 6590725 | 2-80 | 67402 | 2-25 | 6945140 | 2-45 | 753...AN | 3-55 |
| 64714 | 2-17 | 65908... | 2-80 | 677... | 2-63 | 6951125 | 2-44 | 753...R | 3-55 |
| 64715 | 2-18 | 6590825 | 2-80 | 678 | 2-25 | 6957240 | 2-47 | 754... | 3-56 |
| 6472160 | 2-57 | 6590850 | 2-81 | 67801 | 2-46 | 6958... | 2-47 | 755... | 3-57 |
| 6472195W | 2-57 | 65909... | 2-82 | 67802 | 2-46 | 6959180 | 2-47 | 755...A | 3-58 |
| 647A... | 2-57 | 65909Q... | 2-82 | 67901 | 2-52 | 6961300 | 2-43 | 755...Q | 3-59 |
| 647H... | 2-58, 2-59 | 65910... | 2-82 | 67902 | 2-52 | 6962350 | 2-43 | 755S... | 3-58 |
| 647H...72 | 2-58 | 65910Q... | 2-82 | 67903 | 2-52 | 6963330 | 2-44 | 756... | 3-58 |
| 647H314-72 | 2-59 | 65911... | 2-81 | 67904 | 2-53 | 6964... | 2-44 | 756...A | 3-59 |
| 648... | 2-62 | 65912... | 2-81 | 67905 | 2-53 | 6965265 | 2-44 | 756...F | 3-59 |
| 648...L | 2-62 | 65913... | 2-81 | 67906 | 2-53 | 6971... | 2-44 | 757... | 3-60 |
| 6480607 | 2-62 | 659A... | 2-82 | 6801 | 2-48 | 6972180 | 2-44 | 757...F | 3-60 |
| 649... | 2-54 | 659C2... | 2-81 | 6802 | 2-48 | 6976200 | 2-47 | 757...R | 3-60 |
| 649...A | 2-54 | 659C3... | 2-81 | 6803 | 2-48 | 698... | 2-34 | 757S... | 3-61 |
| 649...AL | 2-54 | 660... | 2-52 | 6804 | 2-47 | 6982 | 2-34 | 758... | 3-61 |
| 649...B | 2-54 | 66101 | 2-52 | 6804B160 | 2-47 | 6983 | 2-34 | 758S... | 3-62 |
| 649200C | 2-54 | 66201 | 2-52 | 6805 | 2-47 | 6985 | 2-34 | 759... | 3-62 |
| 649200D | 2-54 | 66301 | 2-33 | 6806 | 2-48 | 6991015 | 2-62 | 760... | 3-62 |
| 650 | 2-65 | 66302 | 2-33 | 681... | 2-64 | 711... | 3-47 | 760...A | 3-63 |
| 65001 | 2-65 | 66303 | 2-33 | 681A300 | 2-64 | 711...M | 3-47 | 760M... | 3-63 |
| 651 | 2-61 | 664 | 2-19 | 681B400 | 2-64 | 711...N | 3-48 | 761... | 3-63 |
| 65103 | 2-61 | 66402 | 2-83 | 6821 | 2-64 | 7113 | 3-47 | 761...A | 3-63 |
| 65111L | 2-60 | 66404 | 2-83 | 684... | 2-53 | 712... | 3-48 | 762... | 3-64 |
| 65112L | 2-60 | 664A | 2-19 | 684...A | 2-53 | 712...M | 3-48 | 764... | 3-64 |
| 65113L | 2-61 | 664P | 2-19 | 684C... | 2-53 | 712...N | 3-48 | 764...L | 3-65 |
| 65202 | 2-52 | 665B | 2-20 | 68509... | 2-58 | 7123 | 3-48 | 764...T | 3-66 |
| 653 | 2-70 | 666... | 2-20 | 68514... | 2-59 | 713... | 3-48 | 764...TA | 3-66 |
| 653180 | 2-70 | 66601 | 2-20 | 685A09... | 2-58 | 713...M | 3-49 | 764...XL | 3-65 |
| 65401... | 2-36 | 66602 | 2-21 | 685A14... | 2-59 | 713...N | 3-49 | 765...G | 3-67 |
| 65402... | 2-36 | 66603 | 2-21 | 685B09... | 2-59 | 71308 | 3-49 | 765...L | 3-66 |
| 65403 | 2-36 | 666050 | 2-83 | 685C14... | 2-60 | 714... | 3-49 | 765...XL | 3-67 |
| 65404... | 2-36 | 666075 | 2-83 | 685D14... | 2-60 | 715...B | 3-49 | 766... | 3-68 |
| 65405... | 2-36 | 66610 | 2-21 | 68601 | 2-37 | 716... | 3-50 | 766...BL | 3-69 |
| 65406... | 2-37 | 666105 | 2-83 | 68602 | 2-37 | 716300... | 3-49 | 766...L | 3-68 |
| 6551... | 2-63 | 66612 | 2-21 | 68603 | 2-37 | 717... | 3-50 | 766...T | 3-69 |
| 6551...L | 2-63 | 66613 | 2-22 | 687... | 2-32 | 71817004A | 2-62 | 767... | 3-68 |
| 6552...L | 2-63 | 666140 | 2-83 | 6901225 | 2-48 | 71F... | 3-50 | 767...G | 3-67 |
| 6553... | 2-63 | 666150 | 2-83 | 6902... | 2-48 | 724... | 3-50 | 767...L | 3-68 |
| 6553...L | 2-63 | 66618 | 2-22 | 6903... | 2-48 | 725... | 3-51 | 768...K | 3-69 |
| 656 | 2-18 | 66619 | 2-22 | 6904... | 2-48 | 726... | 3-51 | 76F... | 3-69 |
| 65601 | 2-69 | 66620 | 2-22 | 6905160 | 2-49 | 727... | 3-51 | 774... | 3-70 |

| Part No. | Page | Part No. | Page | Part No. | Page | Part No. | Page | Part No. | Page |
|----------|------------|-------------|------|-------------|------------|------------|------|------------------|------|
| 774...A | 3-70 | 80242 | 6-82 | 80531MPB | 9-08 | 80922175 | 4-37 | 8194T | 6-88 |
| 774...B | 3-70 | 802421 | 6-83 | 80531MPP | 9-08 | 80923036 | 4-37 | 82022D | 1-09 |
| 776... | 3-71 | 802422 | 6-83 | 80535... | 5-31 | 80923MPB | 9-03 | 82022DW | 1-09 |
| 784...B | 3-71 | 802423 | 6-83 | 8053585... | 5-31 | 8093... | 5-32 | 82023D | 1-09 |
| 784...U | 3-71, 3-72 | 802424 | 6-83 | 80536... | 5-31 | 8093...MPB | 9-08 | 82023S | 1-09 |
| 791... | 3-72 | 802426 | 6-84 | 80541 | 6-86 | 8093...MPP | 9-08 | 82023U | 1-09 |
| 792... | 3-73 | 80243 | 6-82 | 80541MPB | 9-25 | 80934062 | 5-32 | 82026D | 1-09 |
| 793... | 3-73, 3-74 | 802433 | 6-84 | 80541MPP | 9-25 | 8094... | 6-87 | 82026S | 1-09 |
| 794... | 3-74 | 802434 | 6-84 | 80545... | 6-86 | 8094...MPB | 9-26 | 82026U | 1-09 |
| 795... | 3-74 | 80244 | 6-82 | 80545108... | 6-86 | 8094...MPP | 9-25 | 82028U | 1-09 |
| 8012140 | 4-34 | 80245 | 6-82 | 80546... | 6-86 | 80943066 | 6-87 | 8211 | 8-01 |
| 8013200B | 5-28 | 80246 | 6-82 | 80561 | 7-08 | 8095330 | 5-32 | 8211S | 8-01 |
| 8013215 | 5-28 | 80249 | 6-82 | 80561MPB | 9-34 | 8095430 | 6-87 | 822... | 3-75 |
| 8014... | 6-82 | 8026500 | 7-07 | 80561MPP | 9-34 | 8096... | 7-08 | 823... | 2-78 |
| 8014600 | 6-82 | 8026505 | 7-07 | 80581 | 8-02 | 8096...MPB | 9-34 | 824... | 3-75 |
| 80161000 | 7-07 | 8026820 | 7-07 | 80581MPB | 9-41 | 8096...MPP | 9-34 | 82421 | 9-04 |
| 8016475 | 7-07 | 8028650 | 8-02 | 80581MPP | 9-41 | 8098...MPB | 9-41 | 82422 | 9-04 |
| 80181000 | 8-02 | 8032115 | 4-36 | 806... | 5-31 | 8098...MPP | 9-41 | 82432 | 9-09 |
| 8018650 | 8-02 | 8033165 | 5-30 | 806... | 4-36 | 80986 | 8-03 | 82433 | 9-09 |
| 802202 | 4-36 | 8033200L | 5-30 | 80634 | 6-87 | 81022 | 4-38 | 82441 | 9-26 |
| 802202F | 4-36 | 8034... | 6-84 | 8071 | 9-35 | 81022M | 4-38 | 82442 | 9-26 |
| 802211 | 4-34 | 8034250L | 6-84 | 8073... | 5-31 | 8103... | 5-32 | 825... | 3-76 |
| 802214 | 4-34 | 8036... | 7-07 | 8073...B | 2-66 | 8103...MPB | 9-08 | 825121 | 9-44 |
| 802215 | 4-35 | 8036450L | 7-07 | 8073...BM | 2-66, 2-67 | 8104... | 6-87 | 82531 | 9-09 |
| 802218 | 4-35 | 8038550 | 8-02 | 8073...M | 5-31 | 8104...MPB | 9-26 | 82532 | 9-09 |
| 802219 | 4-35 | 803A4300 | 6-85 | 8073...U | 2-67/2-68 | 8111 | 4-38 | 82541 | 9-27 |
| 80222 | 4-34 | 804...U | 3-75 | 8073...UM | 2-67 | 8112 | 4-38 | 825410 | 9-28 |
| 802220 | 4-35 | 80412...MPP | 9-44 | 8073...UM | 2-67 | 8113 | 4-38 | 82542 | 9-27 |
| 802222 | 4-35 | 8042... | 4-36 | 8073250...M | 2-66 | 812... | 4-38 | 82543 | 9-27 |
| 802223 | 4-35 | 8042...W | 4-36 | 8074... | 6-87 | 81225 | 4-38 | 82544 | 9-27 |
| 802224 | 4-35 | 80420...MPP | 9-46 | 8074...M | 6-87 | 81260Q | 4-38 | 82549 | 9-28 |
| 802234 | 4-35 | 8043... | 5-30 | 8074...M | 2-66 | 81280Q | 4-38 | 82561 | 9-35 |
| 80224 | 4-34 | 8043...MPB | 9-07 | 8074...U | 2-67/2-68 | 8141 | 8-01 | 82562 | 9-35 |
| 80225 | 4-34 | 8043...MPP | 9-07 | 8074...UM | 2-67 | 8141S | 8-01 | 82563 | 9-35 |
| 80226 | 4-34 | 8043...R | 5-30 | 8074...UM | 2-67 | 8142 | 4-39 | 82581 | 9-42 |
| 80229 | 4-34 | 8043...W | 5-30 | 8081 | 9-36 | 8143 | 4-39 | 82581S | 9-42 |
| 8023...S | 5-30 | 80435... | 9-07 | 8081D | 9-36 | 8144 | 4-39 | 82585 | 9-42 |
| 802311 | 5-29 | 80435...M | 9-08 | 8081DS | 9-36 | 8145 | 4-39 | 82585S | 9-42 |
| 802315 | 5-29 | 8044... | 6-85 | 8081S | 9-36 | 8148 | 4-39 | 82586 | 9-42 |
| 802318 | 5-29 | 8044...MPB | 9-25 | 8082 | 9-36 | 8149 | 4-39 | 82586L | 9-42 |
| 802319 | 5-29 | 8044...MPP | 9-25 | 8082D | 9-36 | 8152R | 4-39 | 825A41 | 9-48 |
| 80232 | 5-28 | 8044...R | 6-85 | 8082DS | 9-36 | 8154... | 6-88 | 825A41+825B192 | 9-48 |
| 802321 | 5-29 | 8044...W | 6-85 | 8082S | 9-36 | 8154410A | 6-88 | 826... | 3-76 |
| 802322 | 5-29 | 8044080L | 6-85 | 8083 | 9-37 | 8156... | 7-08 | 82601 | 9-28 |
| 802323 | 5-29 | 80454300 | 6-85 | 8083... | 5-32 | 8158650 | 8-03 | 82602 | 9-28 |
| 802324 | 5-29 | 80454430 | 6-86 | 8084... | 6-87 | 815A4315 | 6-85 | 826A01 | 9-49 |
| 80233 | 5-28 | 8046... | 7-08 | 8084...MPB | 9-25 | 8162 | 4-40 | 826A01+825B192 | 9-50 |
| 802334 | 5-30 | 8046...MPB | 9-34 | 8086... | 7-08 | 8163 | 5-32 | 827... | 3-76 |
| 80234 | 5-28 | 8046...MPP | 9-34 | 8091 | 9-37 | 8164 | 6-88 | 82731 | 9-10 |
| 80235 | 5-28 | 8048... | 8-02 | 8091-1 | 9-37 | 8166 | 7-08 | 82733 | 9-10 |
| 80236 | 5-28 | 8048...MPB | 9-41 | 80912...MPP | 9-44 | 8168 | 8-03 | 827A31 | 9-48 |
| 80239 | 5-28 | 8048...MPP | 9-41 | 8091D | 9-38 | 818... | 2-41 | 827A31+825B144 | 9-48 |
| 802411 | 6-83 | 80521 | 4-37 | 8091D-1 | 9-38 | 8192... | 4-40 | 827M... | 3-76 |
| 802412 | 6-83 | 80525... | 4-37 | 8091MD | 9-37 | 8193... | 5-32 | 828... | 3-76 |
| 802415 | 6-83 | 8052565... | 4-37 | 8092... | 4-37 | 8193T | 5-32 | 828A21L | 9-49 |
| 802418 | 6-83 | 80531 | 5-30 | 80920...MPP | 9-46 | 8194... | 6-88 | 828A21L+825B036L | 9-50 |

| Part No. | Page | Part No. | Page | Part No. | Page | Part No. | Page | Part No. | Page |
|----------------|------|----------|------|------------|------|-----------|------|----------|------|
| 828A22 | 9-50 | C2193 | 1-23 | T20718 | 1-15 | T4214-15 | 1-17 | T51210 | 1-19 |
| 828A22+825B120 | 9-50 | C2206 | 1-23 | T20718-3 | 1-15 | T4248 | 1-17 | T51211 | 1-19 |
| 831... | 3-76 | C3661 | 1-23 | T20810 | 1-15 | T4248S | 1-17 | T51214 | 1-19 |
| 832... | 2-62 | C4482 | 1-23 | T20810B | 1-15 | T4281 | 1-17 | T51215 | 1-19 |
| 8334300 | 6-84 | C50412 | 1-23 | T2084 | 1-15 | T4322 | 1-17 | T51215R | 1-19 |
| 87901 | 2-85 | C50630 | 1-23 | T2085 | 1-15 | T4411 | 1-17 | T5122 | 1-19 |
| 88001 | 2-38 | C50631 | 1-23 | T2086 | 1-15 | T4413 | 1-17 | T51226 | 1-20 |
| 88002 | 2-38 | C51220 | 1-23 | T2086T | 1-15 | T5021 | 1-17 | T51226 | 3-32 |
| 88003 | 2-38 | C51221 | 1-23 | T2173 | 1-15 | T5023 | 1-17 | T51226A | 1-20 |
| 88004 | 2-38 | C5136 | 1-23 | T2173 | 3-12 | T5033 | 1-17 | T51226A | 3-32 |
| 88011 | 2-39 | C5142 | 1-23 | T2221B | 1-15 | T5034 | 1-17 | T5131 | 1-20 |
| 88012 | 2-39 | C5153 | 1-23 | T2234L | 1-15 | T5036 | 1-17 | T5134 | 1-20 |
| 881... | 2-41 | C5166 | 1-23 | T2234LB | 1-15 | T5036A | 1-17 | T5135S | 1-20 |
| 88201 | 2-75 | C5203 | 1-23 | T2641 | 1-15 | T5038 | 1-18 | T5161 | 1-20 |
| 88401 | 2-50 | C5211 | 1-23 | T2641-15 | 1-15 | T50410 | 1-18 | T5164 | 1-20 |
| 88402 | 2-50 | C5541 | 1-23 | T2641-24 | 1-15 | T5043A | 1-18 | T5164R | 1-20 |
| 88403 | 2-50 | K2139 | 9-01 | T2741 | 1-15 | T5044 | 1-18 | T5172 | 1-20 |
| 88404 | 2-50 | K2139-2 | 9-01 | T2742 | 1-15 | T5045 | 1-18 | T5181 | 1-20 |
| 88406 | 2-50 | K2231 | 9-02 | T2742-15 | 1-15 | T5046 | 1-18 | T51811 | 1-20 |
| 88407 | 2-50 | K2231-2 | 9-02 | T2742-18 | 1-15 | T5047 | 1-18 | T5331 | 1-20 |
| 88408 | 2-50 | K2413 | 4-15 | T30711 | 1-15 | T5052 | 1-18 | T5861 | 1-20 |
| 88424 | 2-50 | K2463 | 4-18 | T30712 | 1-16 | T5053 | 1-18 | T905M2 | 1-20 |
| 88601 | 2-85 | K3021 | 2-01 | T3121 | 1-16 | T5053A | 1-18 | | |
| 887... | 2-86 | K30714 | 5-04 | T3193 | 1-16 | T5053AF | 1-18 | | |
| 88702 | 2-86 | K3125 | 5-07 | T3212 | 1-16 | T5053F | 1-18 | | |
| 88703 | 2-86 | K3133 | 9-05 | T3224 | 1-16 | T5055 | 1-18 | | |
| 88704 | 2-86 | K3133-3 | 9-05 | T3251-5 | 1-16 | T5056 | 1-18 | | |
| 88901 | 2-40 | K4032 | 9-10 | T3251-5-15 | 1-16 | T5057 | 1-18 | | |
| 890220 | 2-85 | K4033 | 9-11 | T3251-5-18 | 1-16 | T50616S | 1-18 | | |
| 891 | 2-35 | K4079 | 9-12 | T3251-72-5 | 1-16 | T50617 | 1-18 | | |
| 904U2 | 2-25 | K40810 | 9-13 | T3311 | 1-16 | T50618-18 | 1-18 | | |
| 904U5 | 2-25 | K4087 | 6-06 | T3322 | 1-16 | T50618-24 | 1-18 | | |
| 904U6 | 2-26 | K4088 | 9-12 | T3322-15 | 1-16 | T50633AF | 1-18 | | |
| 905M2 | 2-26 | K4099 | 9-13 | T3322-23 | 1-16 | T50633AF | 2-07 | | |
| 906U1 | 2-26 | K41513 | 6-12 | T3322-24 | 1-16 | T50710 | 1-18 | | |
| 910U2 | 2-26 | K50411 | 3-46 | T3331 | 1-16 | T5074 | 1-18 | | |
| 911G3 | 2-27 | K50625 | 3-46 | T3361 | 1-16 | T5075 | 1-18 | | |
| 911M1 | 2-27 | K50916S | 3-41 | T3381 | 1-16 | T5079S | 1-18 | | |
| 912U1 | 2-28 | K50923 | 3-24 | T3521 | 1-16 | T5081 | 1-19 | | |
| 912U2 | 2-28 | K50923F | 3-25 | T4057 | 1-16 | T50810 | 1-19 | | |
| 913U1 | 2-28 | K50923R | 3-27 | T4057-15 | 1-16 | T50811 | 1-19 | | |
| 913U2 | 2-28 | K51024 | 3-24 | T4057-24 | 1-16 | T50812 | 1-19 | | |
| 915U3 | 2-29 | K51024F | 3-26 | T40612 | 1-16 | T50813 | 1-19 | | |
| 915U4 | 2-29 | K51042R | 3-27 | T40612-24 | 1-16 | T50814 | 1-19 | | |
| 924U1 | 2-85 | K51113 | 3-33 | T40613 | 1-16 | T50817 | 1-19 | | |
| 9G0115 | 2-51 | K51210F | 3-26 | T40613-23 | 1-17 | T5081S | 1-19 | | |
| 9M1601 | 2-74 | K51216 | 3-28 | T4116 | 1-17 | T5082 | 1-19 | | |
| 9M1602 | 2-74 | K51225 | 3-26 | T4119 | 1-17 | T50822 | 1-19 | | |
| 9M1603 | 2-75 | K51611 | 3-25 | T4122 | 1-17 | T5085 | 1-19 | | |
| 9U10A.. | 2-41 | K51611R | 3-28 | T4143 | 1-17 | T5085S | 1-19 | | |
| 9U10B.. | 2-41 | K6072 | 7-01 | T4193 | 1-17 | T5089 | 1-19 | | |
| 9U3001 | 2-86 | K64706 | 2-18 | T4194 | 1-17 | T50918 | 1-19 | | |
| 9U3003 | 2-86 | T2045 | 1-15 | T4203 | 1-17 | T5096 | 1-19 | | |
| 9U501... | 2-53 | T2046 | 1-15 | T4205 | 1-17 | T5111 | 1-19 | | |
| C20913 | 1-23 | T20712 | 1-15 | T4212 | 1-17 | T5111S | 1-19 | | |
| C21114 | 1-23 | T20715 | 1-15 | T4214 | 1-17 | T5114 | 1-19 | | |

More Catalogues...



Tool Storage



Auto Special Tools



FORCE OnDemand II



FORCE

Shyang Yun Tools Co., Ltd.
Shyang Yun Hardware Co., Ltd.

No.161, Sitou Rd., Shengang Dist., Taichung City 42953, Taiwan

Tel: +886-4-25631268 Fax: +886-4-25632678

<http://www.force.com.tw> E-mail: Info@force.com.tw

